

c.pCO sistema

Programmable Controller

CAREL



ENG User manual

**LEGGI E CONSERVA
QUESTE ISTRUZIONI**

**READ AND SAVE
THESE INSTRUCTIONS**

  **NO POWER
& SIGNAL
CABLES
TOGETHER**

READ CAREFULLY IN THE TEXT!

Integrated Control Solutions & Energy Savings

IMPORTANT



CAREL bases the development of its products on decades of experience in HVAC, on the continuous investments in technological innovations to products, procedures and strict quality processes with in-circuit and functional testing on 100% of its products, and on the most innovative production technology available on the market. CAREL and its subsidiaries nonetheless cannot guarantee that all the aspects of the product and the software included with the product respond to the requirements of the final application, despite the product being developed according to start-of-the-art techniques.

The customer (manufacturer, developer or installer of the final equipment) accepts all liability and risk relating to the configuration of the product in order to reach the expected results in relation to the specific final installation and/or equipment. CAREL may, based on specific agreements, act as a consultant for the positive commissioning of the final unit/application, however in no case does it accept liability for the correct operation of the final equipment/system.

The CAREL product is a state-of-the-art product, whose operation is specified in the technical documentation supplied with the product or can be downloaded, even prior to purchase, from the website www.CAREL.com.

Each CAREL product, in relation to its advanced level of technology, requires setup / configuration / programming / commissioning to be able to operate in the best possible way for the specific application. The failure to complete such operations, which are required/indicated in the user manual, may cause the final product to malfunction; CAREL accepts no liability in such cases.

Only qualified personnel may install or carry out technical service on the product. The customer must only use the product in the manner described in the documentation relating to the product.

In addition to observing any further warnings described in this manual, the following warnings must be heeded for all CAREL products:

- Prevent the electronic circuits from getting wet. Rain, humidity and all types of liquids or condensate contain corrosive minerals that may damage the electronic circuits. In any case, the product should be used or stored in environments that comply with the temperature and humidity limits specified in the manual.
- Do not install the device in particularly hot environments. Too high temperatures may reduce the life of electronic devices, damage them and deform or melt the plastic parts. In any case, the product should be used or stored in environments that comply with the temperature and humidity limits specified in the manual.
- Do not attempt to open the device in any way other than described in the manual.
- Do not drop, hit or shake the device, as the internal circuits and mechanisms may be irreparably damaged.
- Do not use corrosive chemicals, solvents or aggressive detergents to clean the device.
- Do not use the product for applications other than those specified in the technical manual.

All of the above suggestions likewise apply to the controllers, serial boards or any other accessory in the CAREL product portfolio.

CAREL adopts a policy of continual development. Consequently, CAREL reserves the right to make changes and improvements to any product described in this document without prior warning.

The technical specifications shown in the manual may be changed without prior warning.

The liability of CAREL in relation to its products is specified in the CAREL general contract conditions, available on the website www.CAREL.com and/or by specific agreements with customers; specifically, to the extent where allowed by applicable legislation, in no case will CAREL, its employees or subsidiaries be liable for any lost earnings or sales, losses of data and information, costs of replacement goods or services, damage to things or people, downtime or any direct, indirect, incidental, actual, punitive, exemplary, special or consequential damage of any kind whatsoever, whether contractual, extra-contractual or due to negligence, or any other liabilities deriving from the installation, use or impossibility to use the product, even if CAREL or its subsidiaries are warned of the possibility of such damage.

DISPOSAL
DISPOSAL: INFORMATION FOR USERS



Fig. 1

Fig.2

Please read and keep.

With reference to European Union directive 2012/19/EU issued on 4 July 2012 and related national legislation, please note that:

1. Waste Electrical and Electronic Equipment (WEEE) cannot be disposed of as municipal waste but must be collected separately so as to allow subsequent recycling, treatment or disposal, as required by law;
2. users are required to take Electrical and Electronic Equipment (EEE) at end-of-life, complete with all essential components, to the WEEE collection centres identified by local authorities. The directive also provides for the possibility to return the equipment to the distributor or retailer at end-of-life if purchasing equivalent new equipment, on a one-to-one basis, or one-to-zero for equipment less than 25 cm on their longest side;
3. this equipment may contain hazardous substances: improper use or incorrect disposal of such may have negative effects on human health and on the environment;
4. the symbol (crossed-out wheeled bin – Fig.1) even if, shown on the product or on the packaging, indicates that the equipment must be disposed of separately at end-of-life;
5. if at end-of-life the EEE contains a battery (Fig. 2), this must be removed following the instructions provided in the user manual before disposing of the equipment. Used batteries must be taken to appropriate waste collection centres as required by local regulations;
6. in the event of illegal disposal of electrical and electronic waste, the penalties are specified by local waste disposal legislation.

Warranty on the materials: 2 years (from the date of production, excluding consumables).

Approval: the quality and safety of CAREL INDUSTRIES Hqs products are guaranteed by the ISO 9001 certified design and production system.

WARNING: separate as much as possible the probe and digital input signal cables from the cables carrying inductive loads and power cables to avoid possible electromagnetic disturbance.
Never run power cables (including the electrical panel wiring) and signal cables in the same conduits.

**NO POWER
& SIGNAL
CABLES
TOGETHER**

READ CAREFULLY IN THE TEXT!

Content

1. INTRODUCTION	7
1.1 Functional layout.....	8
1.2 Terminals	9
1.3 BMS port expansion cards (c.pCO Small...Extralarge).....	9
1.4 Fieldbus port expansions cards (c.pCO Small...Extralarge)	10
1.5 External modules.....	10
2. DESIGN	11
2.1 c.pCO design.....	11
3. COMMUNICATION PORTS	13
3.1 Serial ports.....	13
3.2 Ethernet ports.....	14
3.3 Controller network connections	14
4. INSTALLATION	15
4.1 Mounting and dimensions	15
4.2 Installation	16
4.3 Preliminary operations.....	17
4.4 Electrical connections.....	17
4.5 Connecting the terminal.....	19
4.6 Input/output labels.....	20
4.7 I/O table	21
4.8 c.pCOmini e c.pCOe : connections terminals.....	22
4.9 c.pCO Large and Extralarge: connection terminals.....	25
5. INPUT/OUTPUT CONNECTIONS	28
5.1 Power supply	28
5.2 Universal inputs/outputs.....	28
5.3 Digital inputs.....	31
5.4 Analogue outputs.....	33
5.5 Connecting the Ultracap module.....	34
5.6 Connecting the electronic valve	35
5.7 Digital outputs.....	36
5.8 Solid state relay (SSR) digital outputs	37
5.9 General connection diagram c.pCOmini	38
5.10 General connection diagram c.pCO.....	39
6. START-UP	40
6.1 Switching on.....	40
6.2 Private and shared terminal.....	40
6.3 Setting the controller pLAN address.....	40
6.4 Setting the terminal address and connecting the controller to the terminal	41
6.5 Sharing terminals in a pLAN network.....	41
6.6 Uploading/updating the software	42
6.7 c.pCOe expansion board: installation and configuration	45
7. SYSTEM MENU	46
7.1 Menu tree.....	46
8. PROTECTION: PASSWORD AND DIGITAL SIGNATURE MANAGEMENT	48
8.1 Protection features	48
8.2 Protection Password	48
8.3 Digital signature generation	49
8.4 Loading an application program on a controller signed with digital signature..	50
8.5 System menu password.....	50

9. ACCESS MANAGEMENT FOR IP SERVICES	51
9.1 Accounts management.....	51
9.2 Computer - c.pCO connection.....	52
9.3 FTP connection with authentication.....	52
9.4 HTTP connection with authentication.....	53
10. WEB SERVER AND TERA CLOUD PLATFORM	54
10.1 Web kit download and installation.....	54
10.2 Contents of the package.....	54
10.3 Web pGD.....	54
10.4 Variables table.....	54
10.5 Variable trend (logger).....	55
10.6 c.pCO connection to cloud tERA.....	55
11. EXAMPLES	56
11.1 Devices that can be connected to the c.pCO.....	58
12. TECHNICAL SPECIFICATIONS	58
12.1 c.pCO technical specifications.....	58
12.2 FTP commands.....	63

1. INTRODUCTION

c.pCO is a microprocessor-based, programmable electronic controller, featuring a multitasking operating system, compatible with the c.pCO Sistema family of devices, which includes programmable controllers, user terminals, gateways, communication devices and remote management devices. These devices represent a powerful control system that can be easily interfaced with most Building Management Systems (BMS) available on the market. The controller has been developed by CAREL to provide solutions for several applications in air-conditioning, refrigeration and HVAC/R in general. Its flexibility allows for creation of tailor made control solutions according to customer specifications. Compared to pCO sistema, the range is enhanced by a new compact controller, and consequently comprises the c.pCOmini (4 DIN module and panel mounting version), featuring 10 universal inputs/outputs and available with built-in driver for single-pole electronic expansion valve, as well as the c.pCO Small, Medium, Large, ExtraLarge models. The number of inputs/outputs can be increased by connecting a c.pCOe expansion board.

Medium size controllers can feature also one or two built-in drivers for electronic expansion valves. The Ultracap module (accessory) can be used as an emergency power supply for valve drivers, so as to ensure total closure of the valves in case of power failures (alternating current).

c.pCO can be connected in an Ethernet LAN to other c.pCO family controllers. Each device in the LAN can exchange digital or analogue variables with all the others, based on the application program used. c.pCO can also be connected via a pLAN (pCO Local Area Network) to the pGD range of terminals.

Each Fieldbus serial port, whether built into the controller or installed via an optional card, can be connected to controlled field devices such as valve and damper actuators and external drivers (e.g. drivers for electronic expansion valves, EVD Evolution).

Each BMS serial port, whether built into the controller or installed via an optional card, can be connected to field-level, automation-level or management-level standard bus systems, such as Konnex®, LON®, BACnet™, etc.

The real-time operating system (OS) manages priorities so as to ensure the application program cycle time, 32-bit data and floating point numbers, and the Ethernet multimaster and multi-protocol connection.

Main features:

- optimization of the memory occupied by the Operating System and the application program, of the boot time, of the time for loading the application program and of the cycle time;
- system response time optimization: the controller executes several processes in parallel, each managed with a different priority;
- independent processes: each process, whether a protocol, USB port management, data and alarm log (datalogger), data exchange with tERA cloud service, works independently of the others;
- runtime debug (on target)
- native management of TCP/IP multitasking protocol

Local connectivity:

- built-in web server, completely customisable, supports HTML standard and JavaScript. The 90 Mbyte memory can be used to store pages created using the most common website development tools. Dynamic methods (CGI, Common Gateway Interface) are available to read and write the application program variables. Other innovative functions include: the possibility to display the contents of the pGD1 terminal in the browser, display graphs of data recorded by the datalogger and plot data from probes and energy meters in real time (variable trends);
- file server (FTP): the c.pCO public file system can be accessed in the local network via FTP. Consequently, an FTP client can be used to connect to the controller so as to upload updates, web pages and documents. The ".csv" (comma separated value) files exported by the datalogger can be downloaded
- creation of accounts with different access privileges, associated to both a webserver and an FTP server;
- management of multiple simultaneous instances of Modbus TCP/IP Master and Slave protocol;
- management of BACnet™ protocol with B-BC profile (MSTP or TCP/IP, license to be purchased separately).

Remote connectivity:

- integrated connectivity to the Carel tERA cloud service: by connecting a normal router to the controller, a secure connection can be established to the tERA server. Remote services can be activated for the management of control variables, alarm notification, data analysis and reports. The connections are encrypted using the SSL (Secure Socket Layer) standard, in compliance with NIST, international reference for information security over the internet.
- a firewall guarantees remote access only via a secure connection (tERA cloud connection or encrypted VPN)

Integrated USB peripheral: it can be used to update the controller and save web pages, documents and applications in the flash memory. Also used to download the logs from the controller.

- c.pCO Small...Extralarge: the host and device USB ports are managed directly by the operating system. USB host (top): a USB flash drive can be used to load updates (operating system/application program) on the controller. USB device port (bottom): by connecting c.pCO to a personal computer, its memory is made available as a removable drive, and at the same time a communication channel is established with the c.suite software for programming and online debugging.
- c.pCOmini: the 2 USB ports are physically integrated into a single micro USB port; the same performance is available as for the two ports on the larger models.

Other features:

- the same controller can be connected to up to 3 pGD1/pGDE terminals (semi-graphic terminals such as pGDs or touch screens such as pGDT / pGDx);
- external or built-in terminal with display and keypad with LED backlit buttons, can be used for uploading software and commissioning;
- universal inputs/outputs configurable via an application program, for connecting active and passive probes, digital inputs, analogue and PWM outputs. This extends the possibilities of configuring inputs/outputs without having to install a larger controller;
- possibility to use the c.suite software development environment, installable on a personal computer, for creating and customising the application program, simulating operation, supervising performance and configuring the Ethernet network;
- wide range of models that differ in terms of:
 - size (mini, Small, Medium, Large and Extralarge), to ensure maximum flexibility according to the application;
 - digital outputs (24/230 V relay) and SSR (solid state relay);
 - NO or NC relay outputs
 - integrated optically-isolated/not optically-isolated serial ports;
 - optional built-in display;
 - various types of connectors (spring, screw, etc.).

Software programming suite, c.suite: designed as a set of independent modules, one for each phase in HVAC/R software development, c.suite allows teams of professionals with different skills to work in a group on the same project, increasing efficiency and adopting joint development based on workflow. All the software modules cooperate with each other based on centralised data exchange, optionally managed by a software version number (SVN):

- c.strategy: environment where expert algorithm programmers prepare the core of the application program. Features of the programming environment:
 - total independence of programming logic from the hardware and the connected devices;
 - availability of IEC 61131 standard languages: ST (structured text), FBD (function block diagram), SFC (sequential function chart), LD (Ladder diagram), which can also be used simultaneously;
 - datatype management: 32-bit, floating point, array and native structures;
 - debug on target via USB port or Ethernet;
- c.mask: dedicated environment for developers of the user interface.
- c.design: definition of configurations, such as controller type and size, type of inputs/outputs, master/slave protocols, default parameter values, datalogger, network address and user management, connection to tERA cloud services.
- c.factory: used to program the controller, loading the application program

and the appropriate unit configuration during assembly.

Applications

When provided with a dedicated application program, the controller can be used to control different kinds of equipment:

- chillers and heat pumps;
- roof-top units;
- air-conditioners;
- small/medium-sized air handling units (on request);
- refrigerated showcases (on request and to specifications);
- cold rooms (on request and to specifications);
- curing rooms;
- compressor racks;
- universal stage controllers.

Note: from version 4.5 of the operating system, the following screens have been modified: Application statistics and Memory info. See the chapter "System menus".

1.1 Functional layout

The figure below shows the functional layout of an air handling unit. Damper actuators and valve actuators are field devices that communicate through Fieldbus 1 (ref. C). Fieldbus 2 (ref. E) is the medium through which the serial probes communicate the values measured, and through which the humidifier control board and the fans exchange data and receive set points from the controller. The built-in terminal and the remote terminal, which communicate via pLAN (ref. A), are used for installing the application program and for commissioning the system. The PGD touchscreen terminal, intuitive and simple to use, can be used while the unit is normally working to set switch-on and switch-off times, to enter the main parameters, to perform other advanced functions of the application program and to view any alarms triggered. In this case data are exchanged via Ethernet port (ref. D). In the same network it is possible to connect another c.pCO controller as well as to communicate with remote cloud service tEra or to BACnet™ supervisor. The system can be connected to other supervision systems (Konnex®, LON®, etc.) after installing the relative BMS1 expansion card (ref. B).

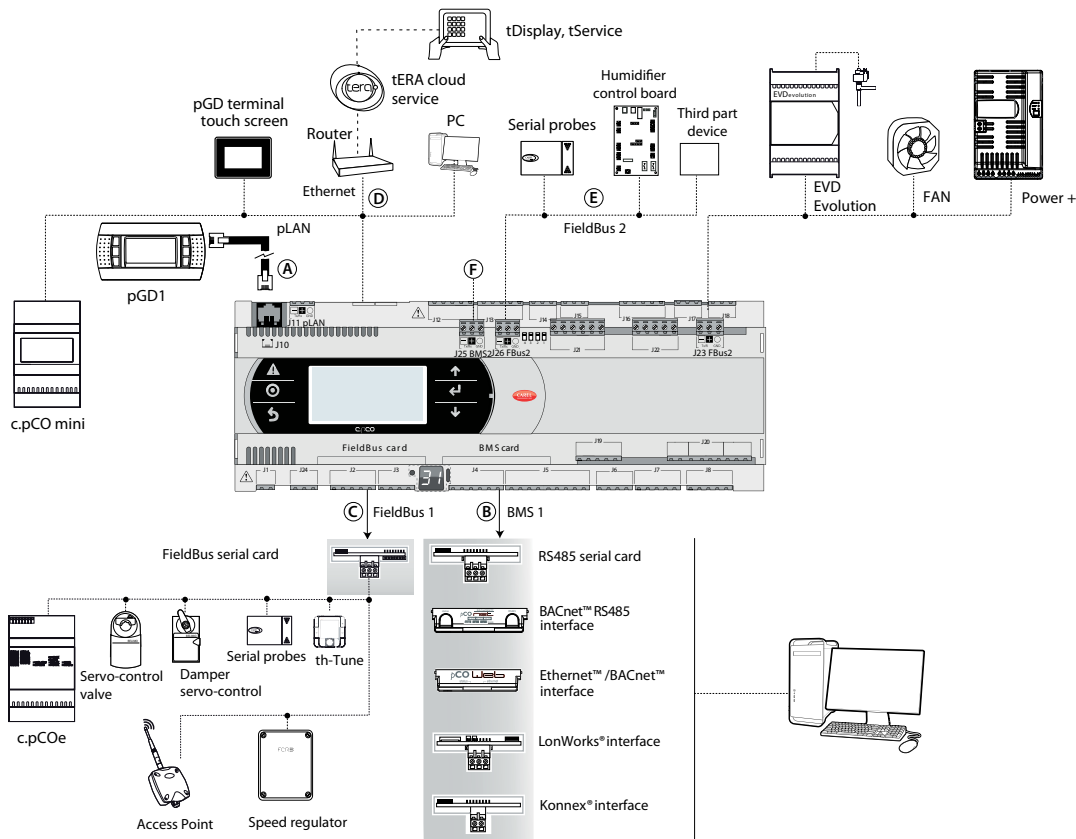









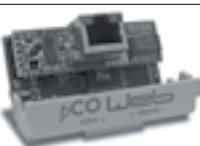



Fig. 1.a

Ref.	Serial port/Connectors	Connection to:
A	pLAN/J10, J11	up to 3 terminals (semi-graphic terminals such as pGDs or touch screens such as pGDT / pGDx)
B	BMS 1 Serial Card	a building automation system, after installing the special BMS card (see par. 1.3)
C	FieldBus 1 Serial Card	sensors, actuators, etc., on a Fieldbus, after installing the special card (see par. 1.4)
D	Ethernet	pGD Touch terminals, c.pCO controllers, Router-->tERA
E	FieldBus 2 / J26 (e J23 in Large, Extralarge models)	sensors, actuators, etc., on a Fieldbus (built-in card)
F	BMS 2 / J25	other devices (built-in card)



1.2 Terminals

	P/N	Description	Notes
	PGDT04000F*** (tech. leaflet +050001475)	pGD Touch 4.3" user terminal	The pGD Touch 4.3" graphics terminal belongs to the family of touchscreen terminals, designed to simplify and make more intuitive the interfacing of users with the controllers of the pCO Sistema family. The electronic technology applied and the new 65,000-colour display allows the terminal to handle high-quality images and advanced functions, providing an excellent aesthetic performance. In addition, the touchscreen panel facilitates man-machine interaction, making it easier to navigate through the various screens.
	PGDT07000F*** (tech. leaflet +050001490)	pGD Touch 7" user terminal	See description of pGD Touch 4.3" user terminal.
	PGDE000* (tech. leaflet +050001450)	pGD graphic terminal	Allows complete graphics management through the use of icons (defined during the development of the application software) and management of international fonts in two sizes: 5x7 and 11x15 pixels. The application software resides only on the c.pCO controller; the terminal requires no additional software for operation. Accessories for installation: <ul style="list-style-type: none"> • telephone connection cable P/N S90CONN00*; • connection cable for c.pCOmini P/N S90CONN0S0; • TCONN6J000 connection card (technical leaflet +050002895).
	PLD**GFP00 (tech. leaflet +050001840)	pLDPRO graphic terminal	Allows complete graphics management through the use of icons (defined during the development of the application software) and management of international fonts in two sizes: 6x8 and 12x16 pixels and audible signal via buzzer. The application software resides only on the c.pCO controller; the terminal requires no additional software for operation, and is compatible with graphic interfaces developed for the pGD graphic terminal. Accessories for installation: <ul style="list-style-type: none"> • telephone connection cable P/N S90CONN00*; • connection cable for c.pCOmini P/N S90CONN0S0; • TCONN6J000 connection card (technical leaflet +050002895).
	PGD1000I00 (tech. leaflet +050001055)	Graphic terminal (panel installation)	This model can be installed on the panel. Its graphics properties are identical to those of the PGDE000 terminal*. Accessories for installation: <ul style="list-style-type: none"> • telephone connection cable, code S90CONN00*; • TCONN6J000 shunt card (instructions sheet code +050002895).
	AT* (tech. leaflet +05000161E/ +05000171E)	th-TUNE, terminal for panel or wall installation	Allows the user to adjust the temperature and humidity in residential environments. th-Tune is compatible with the main wall-boxes found in many countries (Italy, U.S., Germany, China).





1.3 BMS port expansion cards (c.pCO Small...Extralarge)

	P/N	Description	Notes
	PCOS004850 (tech. leaflet +050003237)	BMS RS485 serial card	Can be installed on all controllers of the pCO family (except pCOB); allows direct interfacing with an RS485 network, max. baud rate 19200. The card ensures the controller optical isolation from the RS485 serial network.
	PCO1000WB0 (tech. leaflet +050003238)	Ethernet - pCOweb interface card	Can be installed on all controllers of the pCO family (except pCOB); allows connecting the controller to a 10 Mbps Ethernet network and provides the following functions: <ul style="list-style-type: none"> • access to controller data (network variables and parameters) through an Internet browser (e.g. Internet Explorer™) installed on a PC and connected to the network via TCP/IP to pCOWeb; • connection to a supervisor network running the protocols indicated in the instructions sheet.
	PCO1000BA0 (tech. leaflet +050000930)	BACnet MS/TP - pCOnet interface card	Allows connecting the controller to a BACnet MS/TP (Master/Slave Token pass) network. The RS485 connection is optically isolated from the controller.
	PCO1000F0 (tech. leaflet +050004045)	LonWorks® interface card	Allows connecting to a LonWorks® TP/FT 10 network. The program resides in the flash memory located in the socket, and can be programmed directly via the LonWorks® network using network installation and maintenance tools such as LonMaker™. Information on how to program the card is available in the relative manual, code +030221960.
	PCOS00KXB0 (tech. leaflet +050000770)	Konnex interface card	Allows connecting to a network set up according to the Konnex® standard. Two versions available: for BMS port and Fieldbus port.

1.4 Fieldbus port expansions cards (c.pCO Small...Extralarge)

	P/N	Description	Notes
	PCO100FD10 (tech. leaflet +050003270)	RS485 serial card	Allows connecting to an RS485 network (through an electrically isolated interface). The controller consequently acts as a MASTER (i.e. supervisor), therefore other controllers or devices can be connected as SLAVES. Up to 64 devices can be connected.
	PCOS00KXF0 (tech. leaflet +050000770)	Konnex interface card	See description of PCOS00KXB0 serial card (previous paragraph).

1.5 External modules

	P/N	Description	Notes
	PCOS00UC20 (tech. leaflet +0500041IE)	Module Ultracap for c.pCO built-in driver	In case of power failures the module ensures a temporary power supply for the driver only, for the time necessary to immediately close the electronic valves connected (one or two). This avoids having to install a solenoid valve or backup battery kit in the refrigerant circuit.
	EVD0000UC0 (tech. leaflet +0500042IE)	Module Ultracap external	This module, mounted on a DIN rail, can be used as alternative to the Ultracap module (PCOS00UC20). It can also be used in applications with a controller without built-in driver for electronic expansion valves (e.g. pCO Small + EVD Evolution + external Ultracap module). If used with c.pCOmini, the module ensures a temporary power supply for the driver only, for the time necessary to close the electronic valve (see technical leaflet +0500058IE)
	EVD0000E* (tech. leaflet +050004150)	Driver for electronic expansion valve	The driver for electronic expansion valves with two-pole stepper motor is a controller that manages refrigerant expansion in a refrigerant circuit. With the c.pCO family controllers, the version with Modbus/Carel RS485 serial port is required. Alternatively, the driver can work in stand-alone mode.
	CPY* (manual cod. +040000030)	Humidification board KUE CAREL	Used to manage an immersed electrode humidifier and share the main parameters across a CAREL/Modbus RS485 serial line. Equipped with: <ul style="list-style-type: none"> • all the inputs and outputs required to completely and independently control the humidifier; • three LEDs to indicate: alarms (red), steam production (yellow), 24 Vac power supply (green); • can be connected to the CPY terminal (CPYTERM*) or to the supervisor network with Modbus® RTU or CAREL proprietary protocol.
	PCOUMI2000 (tech. leaflet +050003210)	Interface for OEM series humidifiers	Used to control the main parameters on CAREL OEM humidifiers directly from the c.pCO controller. The values measured by the sensors (high level, supply water conductivity, power consumption sensor) are converted into signals that are compatible with the inputs on the controller.
	P+E* (tech. leaflet +0500059IE)	c.pCOe expansion card	Used to increase the number of inputs/outputs on the controller and the number of relays.
	emeter1/ emeter3 (tech. leaflet +0500046ML/ +0500047ML)	Single-phase/three-phase energy meter	Single-phase/three-phase energy meter with LCD to display parameters; ideal for measuring active energy and splitting costs. Supplied with RS485 port (Modbus protocol RTU).
	FCR3 (tech. leaflet +050004065)	Three-phase speed control	The FCR series devices are three-phase electronic voltage controllers that use phase control to adjust the output voltage supplied to the load, based on the input signal. These devices can control asynchronous electric motors on fans.
	WS01AB2M2* (tech. leaflet +0500030ML)	Access point	The Access Point is part of the rTM SE system (Remote Temperature Monitoring) and allows communication between devices via Modbus® protocol (c.pCO sistema, PlantVisor) and wireless sensors (WS01*) or other routers (WS01*).
	DPW*, DPP*, DPD* (tech. leaflet +050001235, +050001245)	Serial probes	The DP* series temperature and humidity probes for rooms, service environments and duct have been developed for the residential and light industrial HVAC/R market. The range includes models with 0 to 10 V output and RS485 serial output (Carel or Modbus).

2. DESIGN

2.1 c.pCO design

On the models where they are included, the front panel contains a display and a keypad with 6 backlit buttons that, when pressed individually or in combination, allow the following operations:

- uploading an application program;
- commissioning.

During regular operation and depending on the application program installed, the terminal can be used:

- to edit the main operating parameters;
- to display the quantities measured, the active functions and any detected alarm.

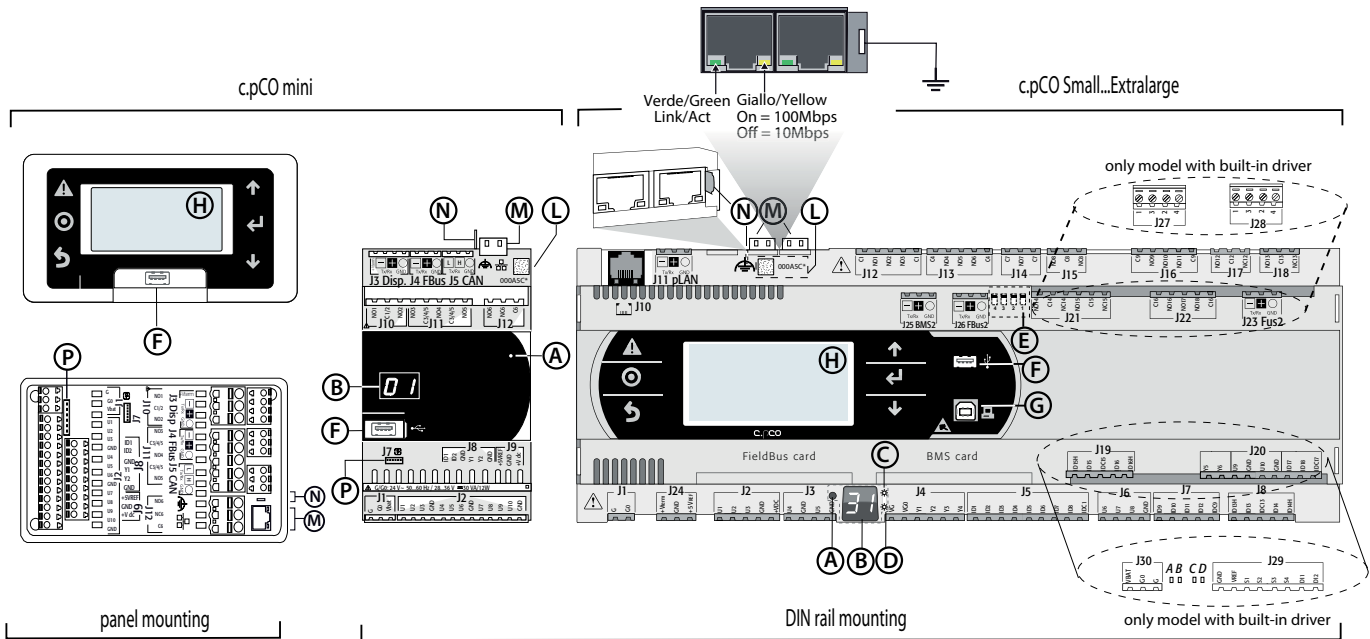

Fig. 2.a

Key:

A	Button to set pLAN address
B	Display pLAN address
C	Power LED
D	Overload LED
E	Jumpers to select FieldBus/BMS on port J26
F	Host USB port (master)

G	Device USB port (slave)
H	Main display
L	MAC address label
M	Ethernet port
N	Ethernet port spades
P	Single-pole valve connector

Each controller is provided with connectors for the inputs/outputs (see chap. 5) and the secondary display, which has a button and a LED for setting the pLAN address. Depending on the model, it can be supplied with a built-in terminal and USB ports.

Keypad

Button	Descr.	Backlighting	Functions
	Alarm	White/Red	pressed together with Enter, accesses the screens managed by operating system.
	Prg	White/Yellow	-
	Esc	White	go back up one level
	UP	White	increase the value.
	Enter	White	confirm the value
	DOWN	White	decrease the value
	Select pLAN address	-	<ul style="list-style-type: none"> • pressed briefly: the pLAN address is displayed brighter • pressed repeatedly: increase the address • release: after a few seconds, the brightness is dimmed and the pLAN address is saved

Note: Once the application program is installed, all button functions depend on the program and do not necessarily correspond to the descriptions above.

Display (c.pCO Small...Extralarge)

Two displays are available:

- the main display on the built-in terminal (if featured);
- the secondary display, which shows the controller pLAN address.

Display (c.pCOmini)

A built-in display is available (if featured), or a secondary display that displays the controller pLAN address.

LED (c.pCO Small...Extralarge)

Six LEDs are featured:

- 1 yellow LED indicating that the device is powered;
- 1 red LED indicating an overload on the +VDC (J2-5) terminal;
- 4 LEDs indicating valve status (only on c.pCO built-in driver models).
Flashing LEDs mean the valve is moving; steady on LEDs mean the valve is completely open or closed.

LED	Colour	Description
A	Yellow	close valve A (connector J27)
B	Green	open valve A (connector J27)
C	Yellow	close valve B (connector J28)
D	Green	open valve B (connector J28)

Microswitches (c.pCO Small...Extralarge)

Four microswitches are provided to configure port J26 as a Fieldbus or BMS port (see "Port J26 configuration").

USB ports

c.pCO Small...Extralarge

The controller features two USB ports, which can be accessed after removing the cover in order to perform operations such as loading the application program and the operating system, saving the logs, etc.

- a "host" USB port for connecting pendrives;
- a "device" USB port for direct connection to the USB port of a computer.

c.pCOmini

c.pCOmini models features a single micro USB port for operations such as loading the application program and the operating system, saving the logs, etc.

- the same USB port acts both as "host" port for connecting a USB flash drive, as well as "device" port for direct connection to a computer.

Mac Address label

Label with QR code containing the Mac Address that uniquely identifies the controller on the Ethernet network

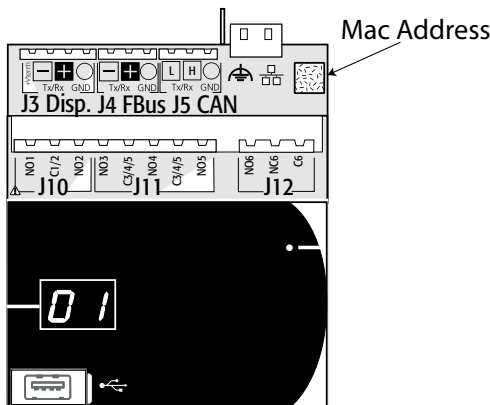

Fig. 2.b

3. COMMUNICATION PORTS

3.1 Serial ports

c.pCO Small...Extralarge

- The controllers come with five serial ports:
- a terminal port on connector J10-J11 (pLAN)
 - a built-in BMS port on connector J25 (BMS2)
 - a built-in Fieldbus port on connector J26 (FBus2).
 - a BMS port to be used with the c.pCO family BMS expansion card (BMS1)
 - a FieldBus port to be used with the c.pCO family BMS expansion card (FBus1)

On the c.pCO Large and Extralarge version, connector J23 is available, marked FBus2, in the same way as connector J26. From the point of view of application program management, this is the same serial line, so different addresses must be used for devices connected to both connectors, while from the electrical point of view the ports are independent (an electrical fault on port J26 does not affect port J23). See the "Technical Specifications" table (chap. 12).

c.pCOmini

- The controller features:
- a terminal port on connector J3 (Disp.)
 - a built-in BMS port on connector J6 (BMS, only on the c.pCOmini Enhanced model)
 - a built-in Fieldbus port on connector J4 (FBus, on the c.pCOmini Enhanced and High End models).

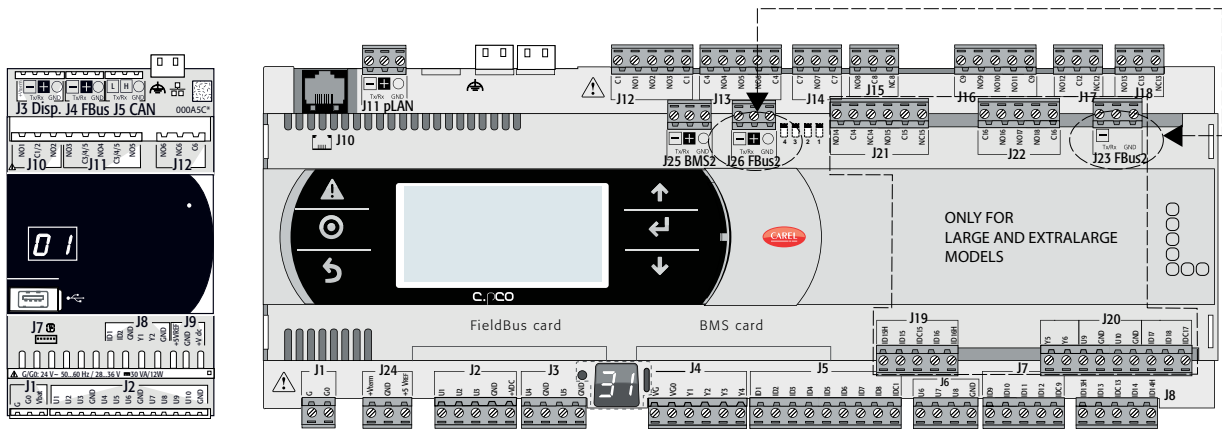

Fig. 3.a

Interface	Type/Connectors	Control	Features
Ethernet	RJ45	c.pCOmini High End c.pCO Small...Extralarge	<ul style="list-style-type: none"> • one 10/100 Mbps Ethernet port • two equivalent 10/100 Mbps Ethernet ports (100-BASE TX standard)
Serial ZERO	J3 Disp.	c.pCOmini	<ul style="list-style-type: none"> • Integrated on main board
Serial ZERO	pLAN/J10, J11	c.pCO Small...Extralarge	<ul style="list-style-type: none"> • HW driver: asynchronous half duplex RS485 pLAN • Not optically-isolated • Connectors: telephone jack + 3-pin plug-in connector (4-pin plug-in connector only on c.pCOmini)
Serial ONE	BMS 1 Serial Card	c.pCO Small...Extralarge	<ul style="list-style-type: none"> • Not integrated on main board • HW driver: not present • Can be used with all c.pCO family BMS expansion cards
Serial TWO	FieldBus 1 Serial Card	c.pCO Small...Extralarge	<ul style="list-style-type: none"> • Not integrated on main board • HW driver: not present • Can be used with all c.pCO family Fieldbus expansion cards
Serial THREE	J6 BMS BMS 2 / J25	c.pCOmini Enhanced c.pCO Small...Extralarge	<ul style="list-style-type: none"> • Integrated on main board • HW driver: asynchronous half duplex RS485 Slave • Optically-isolated/non-optically-isolated serial port • 3-pin plug-in connector
Serial FOUR	J4 FBus	c.pCOmini Enhanced and High End	<ul style="list-style-type: none"> • Integrated on main board • HW driver: asynchronous half duplex RS485 Master
	FieldBus 2 / J26 (and J23 Large - Extralarge version)	c.pCO Small...Extralarge	<ul style="list-style-type: none"> • Integrated on main board • HW driver: asynchronous half duplex RS485 Master or Slave (see par. " J26 port configuration") • J23: not optically-isolated • J26: optically-isolated/not optically-isolated • 3-pin plug-in connector • J23 and J26 are both managed by the same protocol as serial 4, with the advantage of being electrically independent.

Tab. 3.a

Port J26 configuration (c.pCO Small...Extralarge)

c.pCO Small...Extralarge controllers are provided with 4 microswitches for configuring serial port J26 (see figure):

- microswitches all down: port J26 set with Fieldbus hardware;
 - microswitches all up: port J26 set with BMS hardware*.
- Factory configuration: Fieldbus port.

(*) To use the serial port as a BMS connector, the correct communication protocol needs to be set in the application, using the c.suite programming environment.

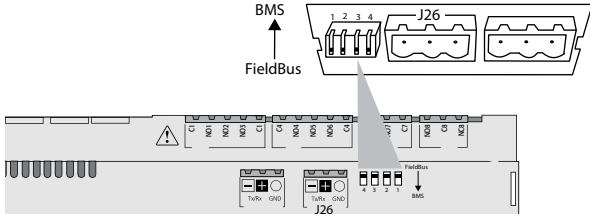

Fig. 3.b

3.2 Ethernet ports

The c.pCO Small...Extralarge controllers have two 10/100 Mbps Ethernet ports. These two ports are connected internally via a switch that automatically forwards any pass-through traffic not addressed to the controller. In the case a failure is happening in an intermediate node (i.e power supply interruption), then the network is disconnected. The two ports feature auto crossover (Auto-MDIX). The c.pCOmini High End controller features one 10/100Mbps/s Ethernet port.

3.3 Controller network connections

Multimaster or Master/Slave networks of c.pCO controllers can be created using the Ethernet ports and the serial ports:

Connection via Ethernet port

The built-in Ethernet ports on the c.pCO can be used to create multimaster and multiprotocol networks, with transmission speeds up to 100 Mbps. The controllers can be connected together via an external switch (see the figure below). For c.pCO Small...Extralarge models, the two Ethernet ports are connected by an internal hub-switch, meaning a daisy-chain network can be created without needing an external switch (see figure 3.c).

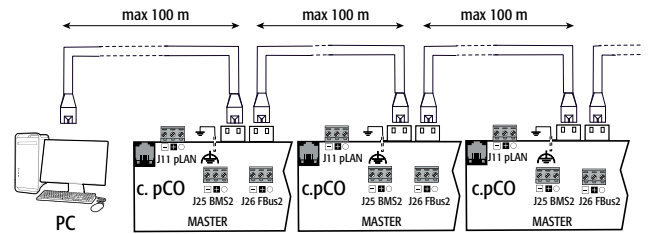
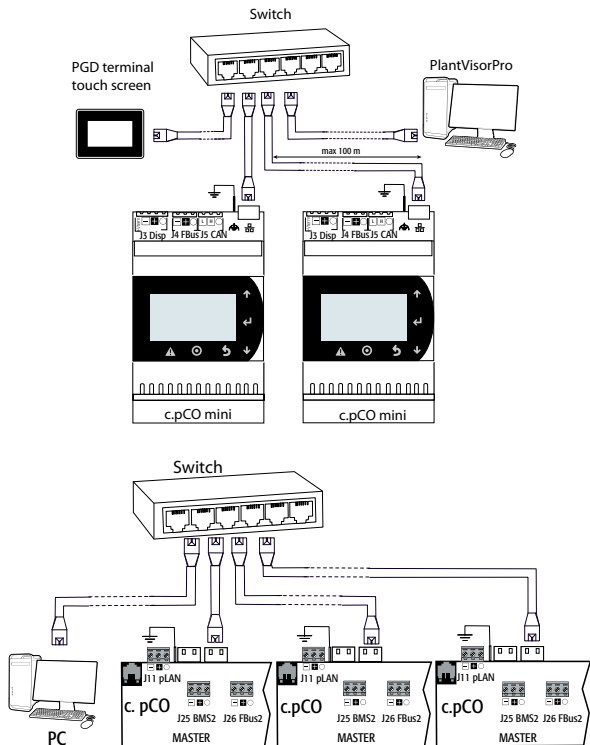

Fig. 3.c

Connection via serial ports:

A master/slave network of c.pCO controllers can be created by using the RS485 serial ports. Such networks comprise:

- one c.pCO controller (Master) that communicates via the Fieldbus RS485 serial port using Carel Master or Modbus Master protocol;
- one or more c.pCO controllers (Slaves) connected to the point-to-point network via the BMS RS485 serial port using Carel Slave or Modbus Slave protocol.

MASTER - SLAVE network

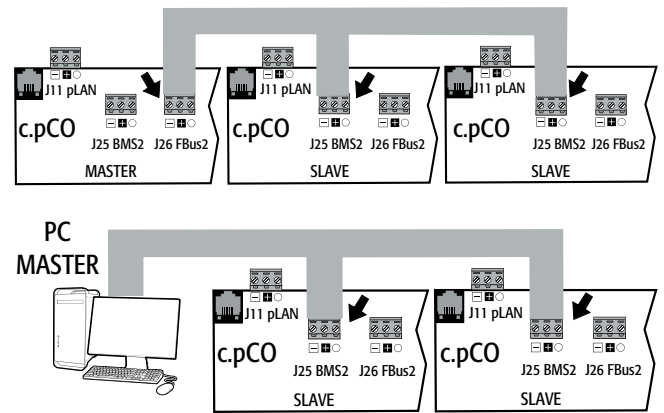

Fig. 3.d



Important warnings:

1. By applying appropriate impedance, a serial port with Master hardware (FBus) supplies the network with the bias voltage required to run all the connected devices, i.e. the master itself and its slaves; conversely, serial ports with slave hardware (BMS) do not provide bias voltage, so it is always advisable to connect at least one device with master hardware (FBus) to the network so that it is correctly biased;
2. However, no more than two devices with master hardware (FBus) can be connected to the same network, otherwise the network total bias impedance becomes too small and incapable of supplying the required voltage to the RS485 network.
3. It is recommended to connect the serial probes or other field devices to an optically-isolated version of the Fieldbus serial port or to serial port TWO – Fieldbus 1 to exploit the filtering properties of optical isolation.

Special cases

- In networks consisting only of Master HW devices, no more than 2 devices can be connected. The max. length allowed for the network is 1000 m. If the network is longer than 100 m, apply the 120Ω, 1/4W terminating resistors to the first and last devices in the network;
- connect the computer to a network with no more than 1 master HW device or no more than 207 slave HW devices.

4. INSTALLATION

4.1 Mounting and dimensions

All models in the c.pCO family can be mounted on a DIN rail, except for the c.pCOmini panel version.

DIN rail assembly: c.pCOmini, c.pCO Small...Extralarge

The following figure shows the dimensions of the c.pCO controllers, according to the model.

Mounting:

- place the controller on the DIN rail and press it down gently. The tabs at the back will snap into place and lock the controller.

Removing:

- lift the tabs using a screwdriver applied to their release slots. The tabs are kept in place by springs.

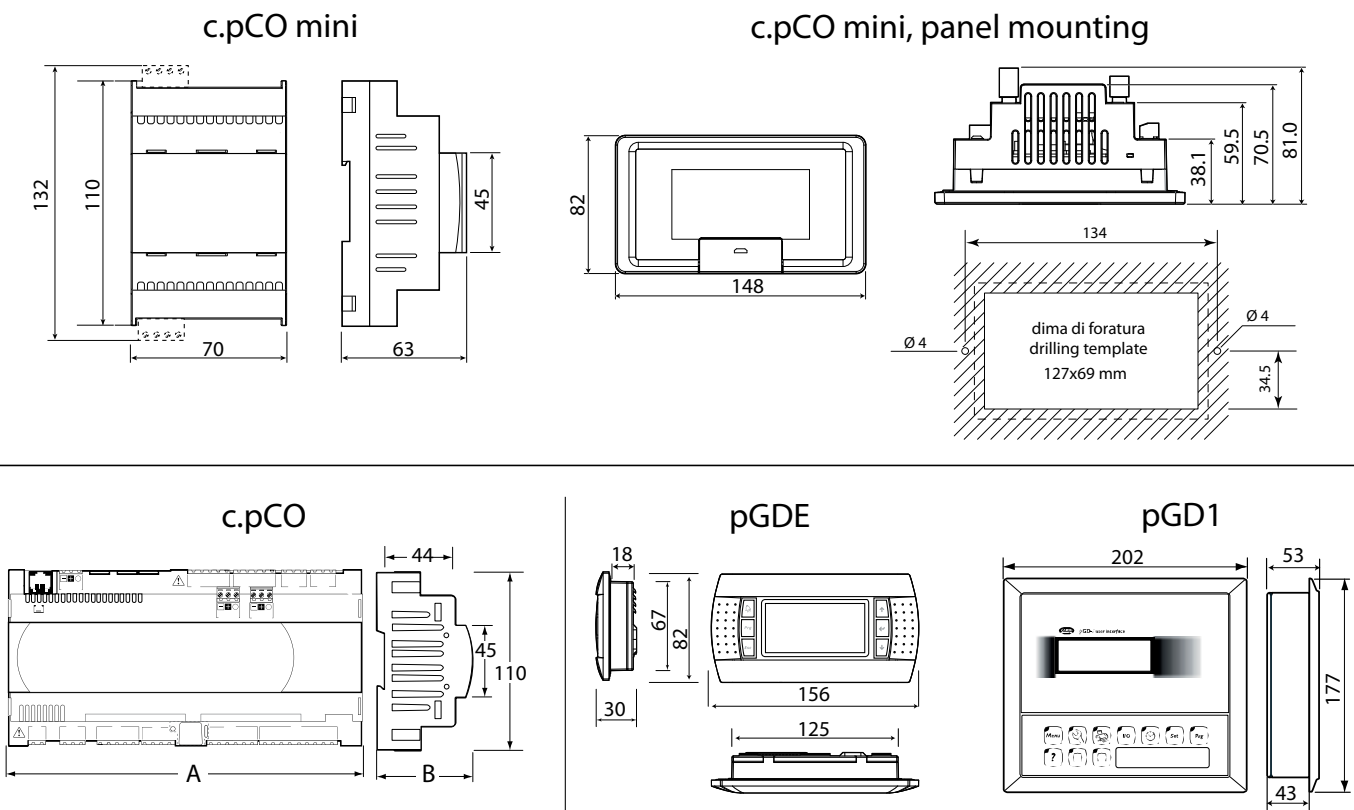

Fig. 4.a

Dimensions (mm)

	Small	Medium	Buit-in driver	Large	Extralarge
A	227,5	315	315	315	315
B	60	60	60	60	60
B - with USB port / built-in terminal	70	70	70	70	70
B - with ULTRACAP module	-	-	75	-	-

Tab. 4.a

Panel installation: c.pCOmini panel version

Procedure:

1. insert the gasket, with the smooth side facing the terminal;
2. place the terminal in the opening;
3. tighten the screws;
4. apply the frame, applying uniform pressure firstly on the 4 corners (points D) and then on the middle points of the frame (points E), until it clicks into place.

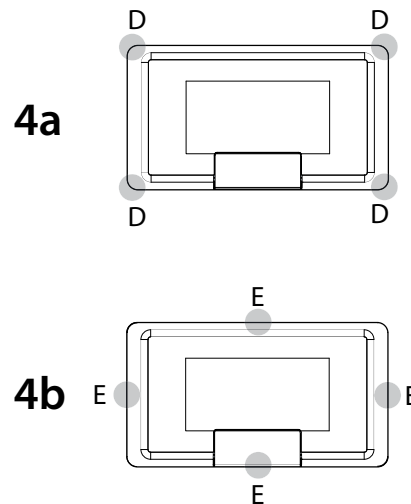
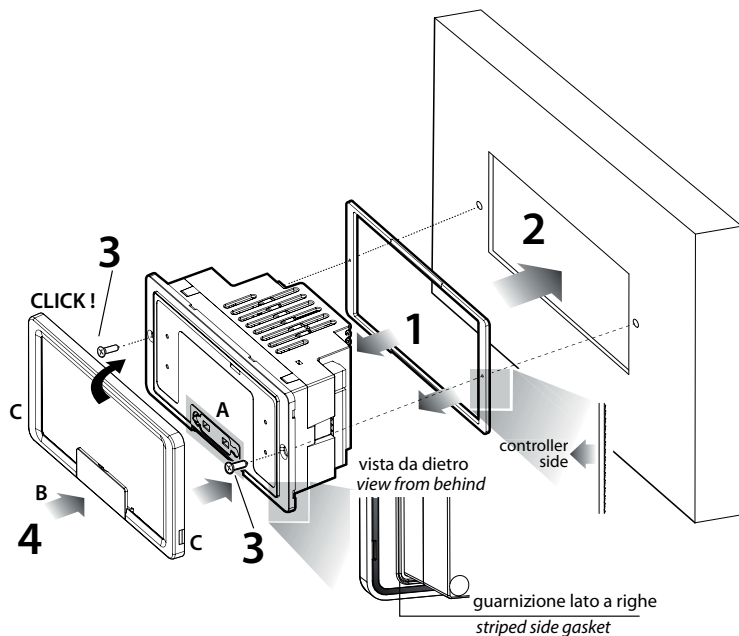

Fig. 4.b



Note:

- for correct assembly, follow the instructions shown in the following diagram.
- Important: when assembling, make sure that the frame is securely in place on all four sides.
- if needing to remove the frame, use a screwdriver to lever it off in slot C.
- to access the USB port, open the cover B and lift the rubber cap A using the tab
- before closing the cover B again, make sure the rubber cap A is properly inserted (it must be flush with the outer plastic surface).
- if needing to cut sheet metal, it is recommended to use laser cutting;
- the thickness of the sheet metal or the material used to make the electrical panel must be suitable to ensure safe and stable installation of the terminal;
- the tension applied by the screws must not cause deformation of the sheet metal, so as to not compromise the degree of protection (IP) shown in the specifications. This degree of protection is guaranteed in the following conditions: maximum deviation of rectangular opening from flat surface $\leq 0.3\text{mm}$, maximum roughness of the surface where the gasket is applied $\leq 120 \mu\text{m}$.

4.2 Installation

Environmental conditions

Avoid installing the controller and the terminal in places with:

- exposure to direct sunlight and to the elements in general;
- temperature and humidity outside the product operating range (see chapter 12, "Technical Specifications");
- large, rapid fluctuations in room temperature;
- strong magnetic and/or radio frequency interference (avoid installing near transmitting antennas);
- strong vibrations or knocks;
- presence of explosives or flammable gas mixtures;
- exposure to aggressive and polluting atmospheres (e.g. sulphur and ammonia vapours, salt mist, fumes) that can cause corrosion and/or

oxidation;

- exposure to dust (formation of a corrosive patina with possible oxidation and reduced insulation);
- exposure to water.

Positioning the controller inside the electrical panel

Install the controller inside an electrical panel in a position where it cannot be reached and it is protected from knocks or impact. The controller should be placed inside the panel in a position where it is physically separated from power components (solenoids, contactors, actuators, inverters, etc.) and their respective cables. The ideal solution is to house these two circuits in two separate cabinets. Proximity to such devices/cables may cause random malfunctions that are not immediately evident. The panel casing must allow an adequate flow of cooling air.



Important:

- for safety reasons the controller should be installed inside an electrical panel so that the only accessible parts are the display and the built-in terminal keypad;
- install the controller so that the disconnect devices can be used safely and without hindrance.
- when laying out the wiring, separate as much as possible the probe cables, digital input cables and serial line cables from the power cables, contactors, thermomagnetic devices, in order to avoid electromagnetic interference;
- never run power cables and probe signal cables in the same conduits (including the ones in the electrical panels);
- for control signals, use shielded cables with twisted wires. If the control cables have to cross over power cables, the intersections should be as close as possible to 90 degrees; under no circumstances should the control cables be laid parallel to the power cables;
- keep the paths of the probe cables as short as possible and avoid making spiral paths that enclose power devices;
- in case of malfunctions do not attempt to repair the device, but contact a CAREL service centre.

Electrical installation

Important: before servicing the equipment, disconnect the controller from the power mains by moving the system main switch to OFF.

Make sure the system is provided with a power disconnect conforming to regulations. Use cable lugs that are suitable for the terminals used. Loosen each screw and insert the cable lugs, then tighten the screws. There is no limit to the number of wires that can be connected to each individual terminal. When tightening the terminal screws apply a tightening torque no greater than 0.6 Nm. For information on the maximum allowable length of the connections to the analogue/digital inputs and to the analogue outputs please refer to the "Technical Specifications" (chapter 12). In environments subject to strong disturbance use shielded cables with the braiding bonded to the earthing conductor in the electrical panel. After making the connection, gently tug on the cables to make sure they are sufficiently tight.

Note:

- secure the cables connected to the controller with clamps placed at 3cm from the connectors;
- if the power transformer secondary winding is earthed, make sure the earth conductor is bonded to the conductor that goes to the controller and is connected to terminal G0. This applies to all the devices connected to the controller through a serial network.

Important:

- using a supply voltage other than specified can seriously damage the system;
- connect the fuse close to the controller;
- the controller should only be installed, serviced and inspected by qualified personnel and in compliance with national and local regulations;
- all the extra low voltage connections (24 Vac/Vdc or 28 to 36 Vdc analogue and digital inputs, analogue outputs, serial bus connections, power supplies) must have reinforced or double insulation from the power mains;
- avoid touching or nearly touching the electronic components mounted on the boards to avoid electrostatic discharges from the operator to the components, which may cause considerable damage;
- do not press the screwdriver on the connectors with excessive force, to avoid damaging the controller;
- using the device in any way other than specified by the manufacturer can compromise its protection;
- use only optional boards and connectors supplied by Carel.

4.3 Preliminary operations

Installing the serial cards

If the Fieldbus and BMS serial cards built into the c.pCO are insufficient for the required application, you can add a Fieldbus serial port and a BMS serial port, which are available as accessories (see chap.1).

To install them, proceed as follows:

- Locate the Fieldbus or BMS serial port.
- using a screwdriver, take off the cover;
- using a pair of nippers, cut out the plastic knock-out to create an opening;
- plug the optional card into the edge connector, making sure it is firmly secured and makes contact;
- put the cover back so that the serial card connector is aligned with the opening;
- make the required electrical connections.

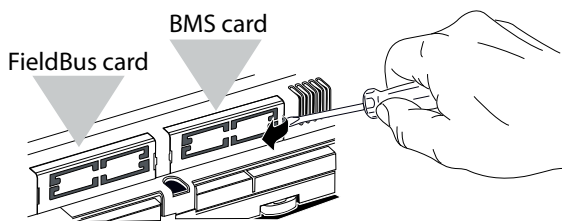

Fig. 4.c

Note: see the technical leaflets for the cards being installed.

c.pCOe expansion board installation

See the technical leaflet +0500059IE.

Ultracap module installation

See the technical leaflets +0500042IE and +0500041IE.

4.4 Electrical connections

Ethernet network

Connections:

- use CAT-5 STP shielded cables;
- always make the earth connection using the male spade near the Ethernet connectors;
- the maximum length of an Ethernet connection is 100 m between consecutive devices

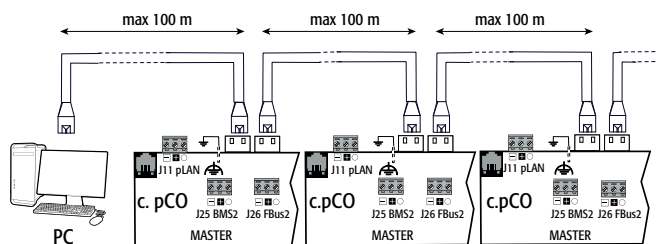

Fig. 4.d

RS485 network

To improve the controller immunity against electromagnetic interference, the serial connection cable should be a shielded twisted pair cable, 2-wire or 3-wire depending on the isolation of the serial connection. The following rule applies:

- if the serial port is isolated (functionally) from the power supply, a third wire is required in the serial cable to act as a common reference for the controllers. If the serial port is not optically isolated and the common reference is already present, no third wire is required.

For the RS485 network, use a twisted pair cable with the specifications shown in the table.

Master device	HW	Lmax(m)	Wire/wire capacitance (pF/m)	Resistor on first and last devices	Max. no. of slave devices on bus	Data rate (bit/s)
c.pCOmini						
FBUS	RS485	2/500 (not shielded/ shielded AWG 24)	< 90	120 Ω	64	19200
PC				120 Ω	207	38400
c.pCO Small...Extralarge						
FBUS	RS485	1000	< 90	120 Ω	64	19200
PC				< 90	120 Ω	207

Note: in case of a Master-Slave network the max. allowable length is 1000 m. If the network is longer than 100 m, apply 120Ω, 1/4W terminating resistors to the first and last devices in the network.

Non-optically-isolated serial port

c.pCOmini: Fieldbus (J4) and BMS (J6).

c.pCO Small...Extralarge: serial ZERO - pLAN (J11), FieldBus 2 (J23 and J26), and BMS2 if not optically isolated (on models with built-in ports that are not optically isolated).

Case 1: multiple boards connected to a Master/Slave network powered by the same transformer. Network length <100 m, terminating resistors are not required (for example, multiple boards connected inside the same electrical panel).

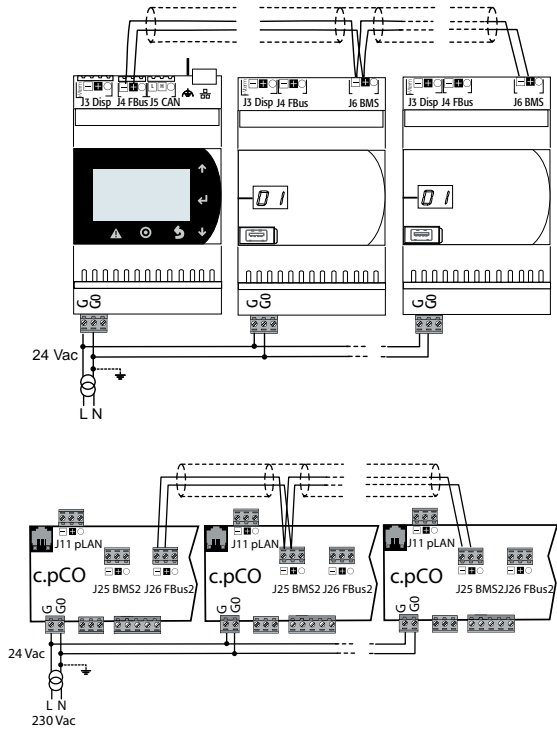

Fig. 4.e

The procedure for earthing the shield is described in the corresponding paragraph.

Case 2: multiple boards connected to a Master/Slave network powered by different transformers (with G0 not earthed); this is a typical application of multiple boards inside different electrical panels. If the network is more than 100 m long, the 120 Ω, ¼ W terminating resistor is required.

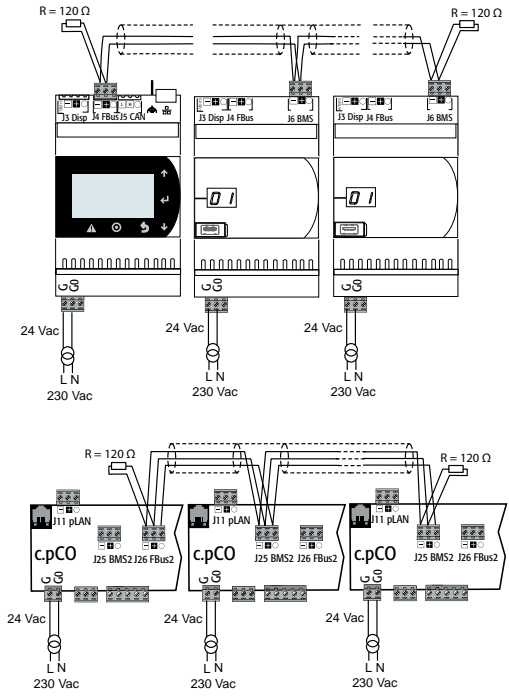

Fig. 4.f

Important: the earth connection (if any) should be made only on one point of the earth line (same earthing terminal for all controllers).

The procedure for earthing the shield is described in the corresponding paragraph.

Optically-isolated serial port

This is the case of serial ONE - BMS1, serial TWO - Fieldbus 1 and the built-in ports serials THREE and FOUR on optically-isolated models. Regardless of the type of power supply or earthing, use a 3-wire shielded cable connected as shown in the figure. If the network is more than 100 m long, the terminating resistor is required.

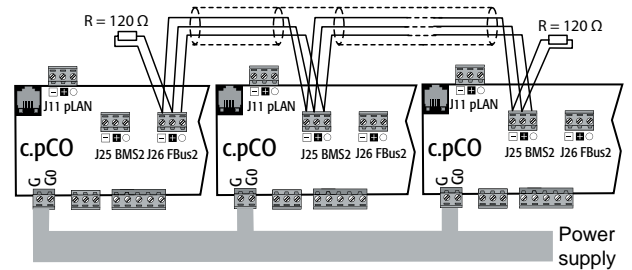

Fig. 4.g

The procedure for earthing the shield is described in the corresponding paragraph.

Procedure for earthing the shield

The shield of the serial cable is earthed differently according to the length, as shown in the figure (where A=FBUS terminal, B=BMS terminal).

Case 1: distance between controllers less than 0.3 m: earth only one end of the cable.

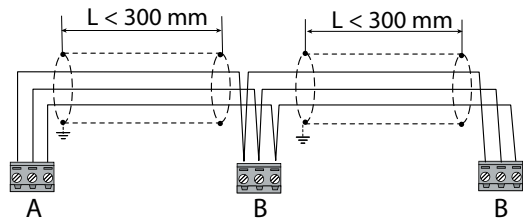

Fig. 4.h

Case 2: distance between controllers greater than 0.3 m: two possibilities. - earth one end with a bridge between the shields

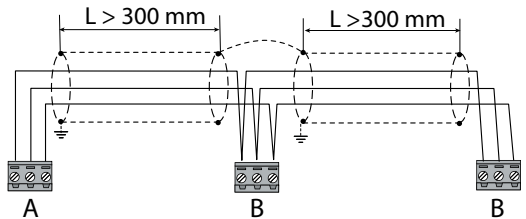

Fig. 4.i

- earth both ends of the cable (no bridge between shields).

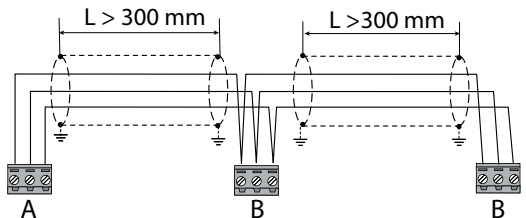

Fig. 4.j

4.5 Connecting the terminal

c.pCOmini

Use the accessory cable P/N S90CONN0S0, connected as shown in the figure. The maximum distance allowed without shielding is 2 meters, from 2 to 50m a shielded cable must be used.

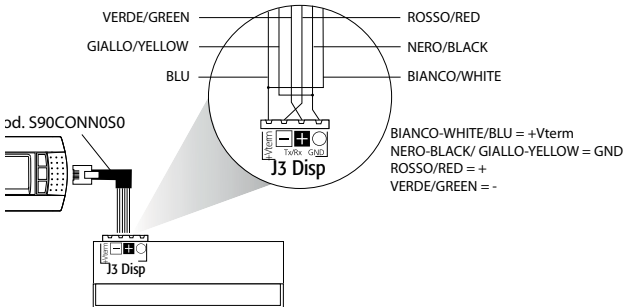

Fig. 4.k

c.pCO Small...Extralarge

The controller and the terminal are connected to a pLAN network.

1: Connecting the terminal to one c.pCO controller

When connecting the controller to the terminal, the following restrictions should be kept in mind:

1. the overall length of the pLAN should not exceed 500 m. Consequently, if the terminal is installed in a remote position, the length of the terminal cable must be included in the total length;
2. the unshielded telephone cable can be used for a max. length of 50 m. Beyond this length, use a 3-wire shielded cable (see the table below);
3. for lengths greater than 200 m, the power supply for the terminal must be provided separately;
4. no more than 3 terminals (semi-graphic terminals such as pGDs or touch screens such as pGDT / pGDx) can be connected to the same c.pCO controller. The terminals must be the same type (e.g. all pGD1). One terminal is powered by the controller, and the other two by an external power supply;
5. except PGD0 / PGD1 / PGDE, other terminals must be powered with separate power supply.

Important:

- in domestic installations, standard EN55014 requires the connection cable between the controller and the terminal to be shielded, with the shield earthed at both ends;
- in industrial installations with length >10 m, the connection cable between the controller and the terminal must be shielded and the shield must be earthed.

Case A: 1 terminal.

A.1: distance $L < 50$ m.

The typical connection for one terminal (e.g. PGD1) is made using a 6-wire telephone cable available from CAREL as an accessory (S90CONN00*). The telephone connector provides both data transmission and the power supply for the terminal.

To make the connection:

- plug the connector into terminal J10 until it clicks into place.

To remove the connector:

- press lightly on the plastic catch on the connector and pull it out.

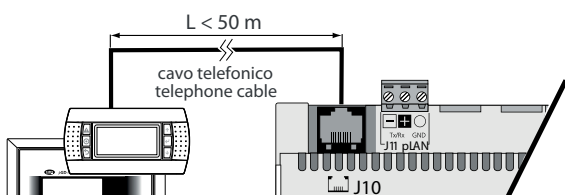

Fig. 4.l

A.2: distance $50 < L < 200$ m.

Lengths greater than 50 m require two TCONN6J000 cards connected with a 4-wire shielded cable, as shown in the figure. The terminal is powered by the controller.

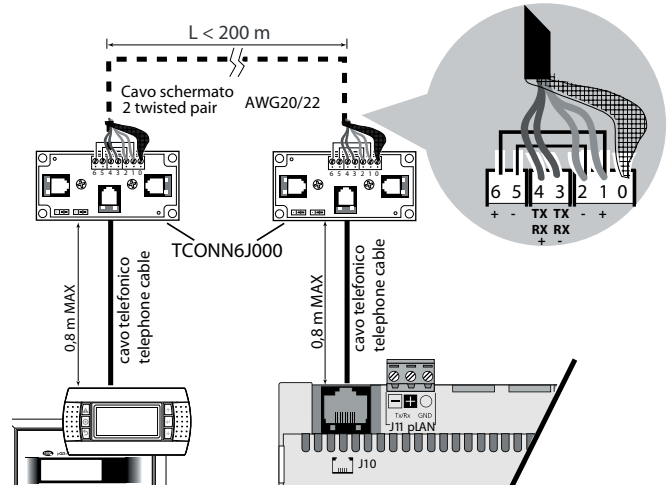

Fig. 4.m

Note: for information on the position of the jumpers on the TCONN6J000 board, see instruction sheet +050002895.

A.3: distance $200 < L < 500$ m.

The terminal must be powered by an external power supply. Connect a 3-wire shielded cable to the pLAN connector (J11). Provide a separate power supply for the TCONN6J000 card, as shown in the figure.

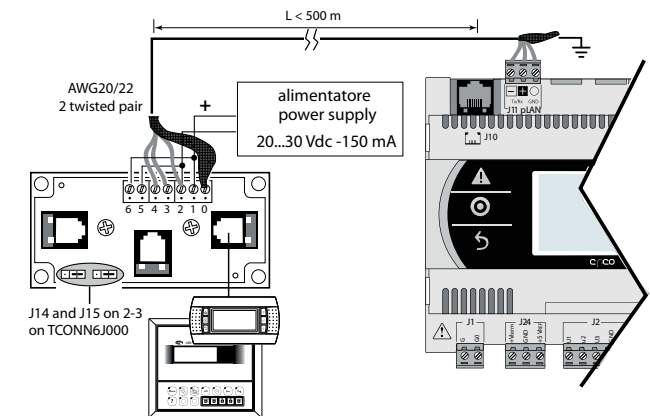

Fig. 4.n

Note: to reach the maximum network length, use a bus layout with branches not exceeding 5 m.

Case B: 2 terminals

Two terminals can be directly connected only on Small models. Other sizes require the second terminal to be powered separately. On Medium/ Large/Extralarge controllers apply configuration A.1, A.2 or A.3.

B.1: distance $L < 50$ m.

Use 1 TCONN6J000 card, connected as shown in the figure.

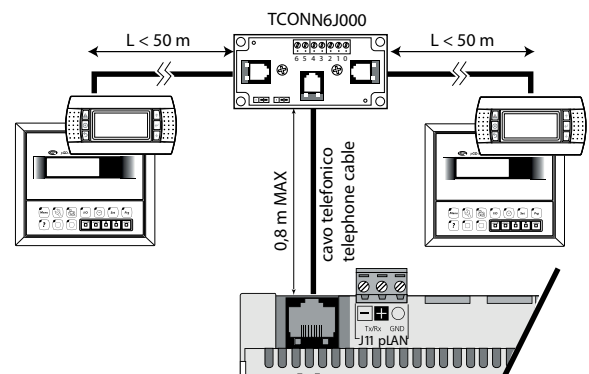

Fig. 4.o

B.2 distance 50 < L < 200 m.

Use 3 TCONN6J000 cards, connected as shown in the figure.

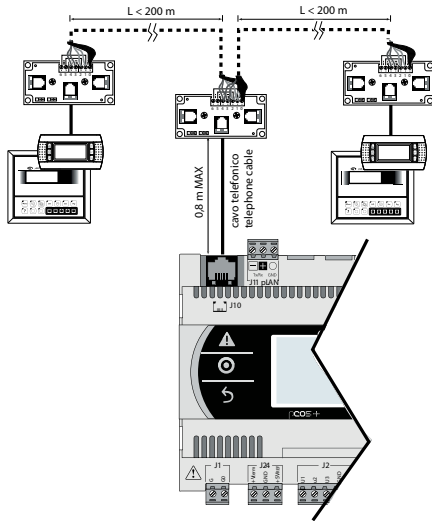

Fig. 4.p

B.3 distance 200 < L < 500 m.

If one of the terminals is connected at a distance >200 m, connect it according to the diagram described in A.3. Connect the other terminal as described in A.1 or A.2. If both terminals are close to a distance > 200 m, connect them as shown in the diagram below:

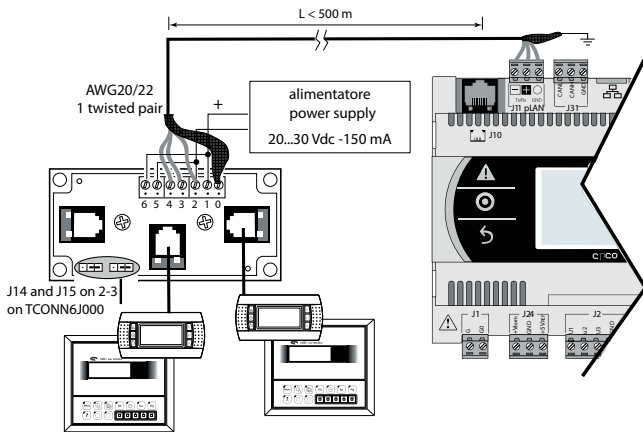

Fig. 4.q

Case C: 3 terminals.

For the first 2 terminals refer to Case B. For the third terminal use one of connections A.1, A.2 or A.3.

Important:

- the 24Vdc at +Vterm (J24) can be used only in alternative to connector J10 to power an external terminal, with maximum current 1.5 W;
- in networks with a star layout, if the cable is longer than 5 m, connect the terminal only to the first or last c.pCO in the network (to avoid branches).

The following table applies.

type of cable	MAX controller-terminal distance (m)	power supply	use TCONN6J000 card
1 telephone	50	from the controller (150 mA)	NO
2 shielded AWG24	200	from the controller (150 mA)	YES
3 shielded AWG20/22	500	separate	YES

2: Shared terminal connection in pLAN network

To share a terminal between several c.pCO controllers, these can be connected in a pLAN network, and the terminal connected to one of the controllers in the network (see the figure below). The previous details on the maximum length allowed between terminal and controller also apply in this case.

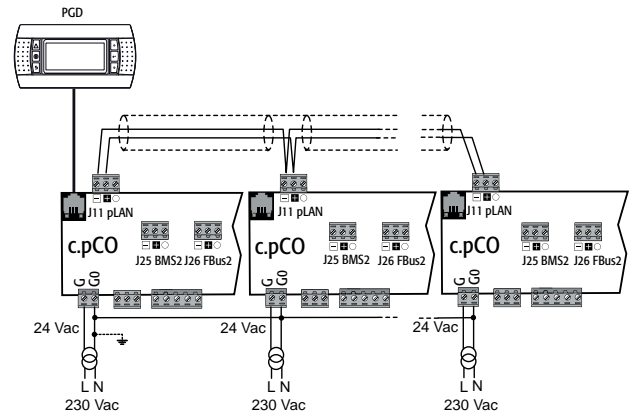

Fig. 4.r



It is possible use one terminal only, sharing it between controllers to display the information relating to each (see the paragraph "Private and shared terminal").

4.6 Input/output labels

c.pCO controllers are distinguished by size and provided with inputs and outputs and power supplies for the active probes most suitable for various applications.

The features that depend on the model are:

- maximum number and type of inputs/outputs;
- availability of built-in driver for expansion valves;
- type of interfaces

label	Type of signal
U...	Universal inputs/outputs, can be configured via software as: Analogue inputs: - NTC PTC, PT500, PT1000 sensors - PT100 sensors - 0 to 1 Vdc or 0 to 10 Vdc signals - 0/4 to 20 mA signals - 0 to 5 V signals for ratiometric probes Digital inputs (not optically-isolated): - voltage-free contacts (not optically-isolated) - fast digital inputs Analogue outputs (not optically-isolated): - 0 to 10 Vdc signals - PWM signals
Y...	0 to 10 Vdc analogue outputs, PWM outputs
ID...	24 Vac/ 24 Vdc digital input
ID...H	230 Vac digital input
NO...	Relay output, normally open contact
NC...	Relay output, normally closed contact
C...	Relay output, common
Tx/Rx, GND	Serial port
	Ethernet port
	Functional earth

Tab. 4.b

4.7 I/O table

		c.pCO Controllers										c.pCOe I/O expansion card						
		mini (Basic)	mini (Enhanced)	mini (High End)	Small	Medium	Large	Extra Large	Built-in driver	Label	In/Out	Type	Basic - c.pCOe	Label	In/Out	Type		
Universal inputs/ outputs	NTC input	10			5	8	10	8	8	U	In	Universal I/O	10	U	In	Universal I/O		
	PTC input	10			5	8	10	8	8	U	In	Universal I/O	10	U	In	Universal I/O		
	PT500 input	10			5	8	10	8	8	U	In	Universal I/O	10	U	In	Universal I/O		
	PT1000 input	10			5	8	10	8	8	U	In	Universal I/O	10	U	In	Universal I/O		
	PT100 input	max 5			max 2	max 3	max 4	max 3	max 3	U	In	Universal I/O	max 5	U	In	Universal I/O		
	0 to 1 Vdc / 0 to 10 Vdc input (powered by controller)	0			max 5	max 6	max 6	max 6	max 6	U	In	Universal I/O	0	U	In	Universal I/O		
	0 to 1 Vdc / 0 to 10 Vdc input (powered externally)	10 (Nota ¹)			max 5	max 8	max 10	max 8	max 8	U	In	Universal I/O	10 (Nota ¹)	U	In	Universal I/O		
	0 to 20 / 4 to 20 mA input (powered by controller)	max tot 4	max 2 (Nota ²)		max 4	max 7	max 6	max 6	max 6	U	In	Universal I/O	max tot 4	max 2 (Nota ²)		U	In	Universal I/O
	0 to 20 / 4 to 20 mA input (powered externally)		max 4		max 4	max 7	max 9	max 7	max 7	U	In	Universal I/O		max 4		U	In	Universal I/O
	0 to 5 V input for ratiometric probe (+5Vref)	max 2			max 5	max 6	max 6	max 6	max 6	U	In	Universal I/O	2	U	In	Universal I/O		
	Digital input w/ voltage-free contact	10			5	8	10	8	8	U	In	Universal I/O	10	U	-	Universal I/O		
	Fast digital inputs	max 2			max 2	max 4	max 6	max 4	max 4	U	In	Universal I/O	max 2	U	-	Universal I/O		
	0 to 10 Vdc output, not optically-isolated	max 5			5	8	10	8	8	U	Out	Universal I/O	max 5	U	-	Universal I/O		
	PWM output, not optically-isolated	10			5	8	10	8	8	U	Out	Universal I/O	10	U	-	Universal I/O		
	max tot 10			max tot 5	max tot 8	max tot 10	max tot 8	max tot 8				max tot 10						
Digital inputs	Optically-isolated 24 Vac/Vdc input	0			8	12	14	12	12	ID	In	Digital input	0	ID	In	Digital input		
	24 Vac/Vdc or 230 Vac (50/60 Hz) input	0			-	2	4	2	2	ID	In	Digital input	0	ID	In	Digital input		
	Voltage-free contacts	0	2	-	-	-	-	-	-	ID	In	Digital input	0	ID	In	Digital input		
	max tot 0			max tot 2	max tot 8	max tot 14	max tot 18	max tot 14	max tot 14				max tot 0					
Analogue outputs	0 to 10 Vdc output, optically-isolated	0			4	4	6	4	4	Y	Out	Analogue output	0	Y	Out	Analogue output		
	0 to 10 Vdc output, not optically-isolated	0	2	0	0	0	0	0	0	Y1, Y2	Out	Analogue output	0	Y1, Y2	Out	Analogue output		
	PWM output, optically-isolated	0			2	2	2	2	2	Y3, Y4	Out	Analogue output	-	-	-	-		
	PWM output, not optically-isolated	0	2	0	0	0	0	0	0	Y1, Y2	Out	Analogue output	0	Y1, Y2	Out	Analogue output		
	Output for single-pole stepper motor	0	1	0	0	0	0	0	0	J7	Out	Analogue output	0	J7	Out	Analogue output		
	Output for two-pole stepper motor	0			0	0	0	0	1/2	1-3-2-4	Out	Analogue output	0	-	-	-		
	max tot 0			max tot 2	max tot 4	max tot 4	max tot 6	max tot 4	max tot 6				max tot 0					
Digital outputs	NO/NC relay output	1			1	3	5	3	3	NO/NC	Out	Digital output	1	NO/NC	Out	Digital output		
	NO relay output	5			7	10	13	26	10	NO	Out	Digital output	5	NO	Out	Digital output		
	24 V SSR output	2			1	2	3/4	2	2	NO	Out	Digital output	2	NO	Out	Digital output		
	230V SSR output	2			1	2	3/4	2	2	NO	Out	Digital output	2	NO	Out	Digital output		
	max tot 6			max tot 8	max tot 13	max tot 18	max tot 29	max tot 13					max tot 6					

16 20 25 39 52 55 41 16 Total I/O

Note 1: CAREL probes, part numbers DP**Q and DP****2, can only be used with external power supply and not powered by c.pCOmini
Note 2: excluding CAREL probes part numbers DP**Q and DP****2.

		c.pCO Controllers										c.pCOe I/O expansion card				
		mini (Basic)	mini (Enhanced)	mini (High End)	Small	Medium	Large	Extra Large	Built-in driver	Label	In/Out	Type	Basic - c.pCOe	Label	In/Out	Type
Power to terminal	0	1			1	1	1	1	1	J10			0	---		Telephone conn. (pLAN) J10
	1	0			0	0	0	0	0	J3 Disp			0			Display port J3
Power to probes	1	1			1	1	1	1	1	+Vterm			0			Add. power to terminal
	1	1			1	1	1	1	1	+VDC			1			Power to active probes
Power to analogue outputs	1	1			1	1	1	1	1	+5VREF			1			Power to ratiometric probes
	0	1			1	1	1	1	1	VG, VGO			0			
Built-in Fieldbus ports	0	1	1	1	1	2	2	1	J23/ J26, J4 (Mini)			0				
Accessory Fieldbus ports	0			1	1	1	1	1	Fbus card			0				
Built-in BMS ports	0	1	0	1	1	1	1	1	J25, J6 (Mini)			1				
Accessory BMS ports	0			1	1	1	1	1	BMS card			0				
Host USB port	1			1	1	1	1	1				0				
Slave USB port	1			1	1	1	1	1				0				
Ethernet	0	0	1	2	2	2	2	2				0				

4.8 c.pCOmini e c.pCOe : connections terminals

c.pCOmini - DIN rail version

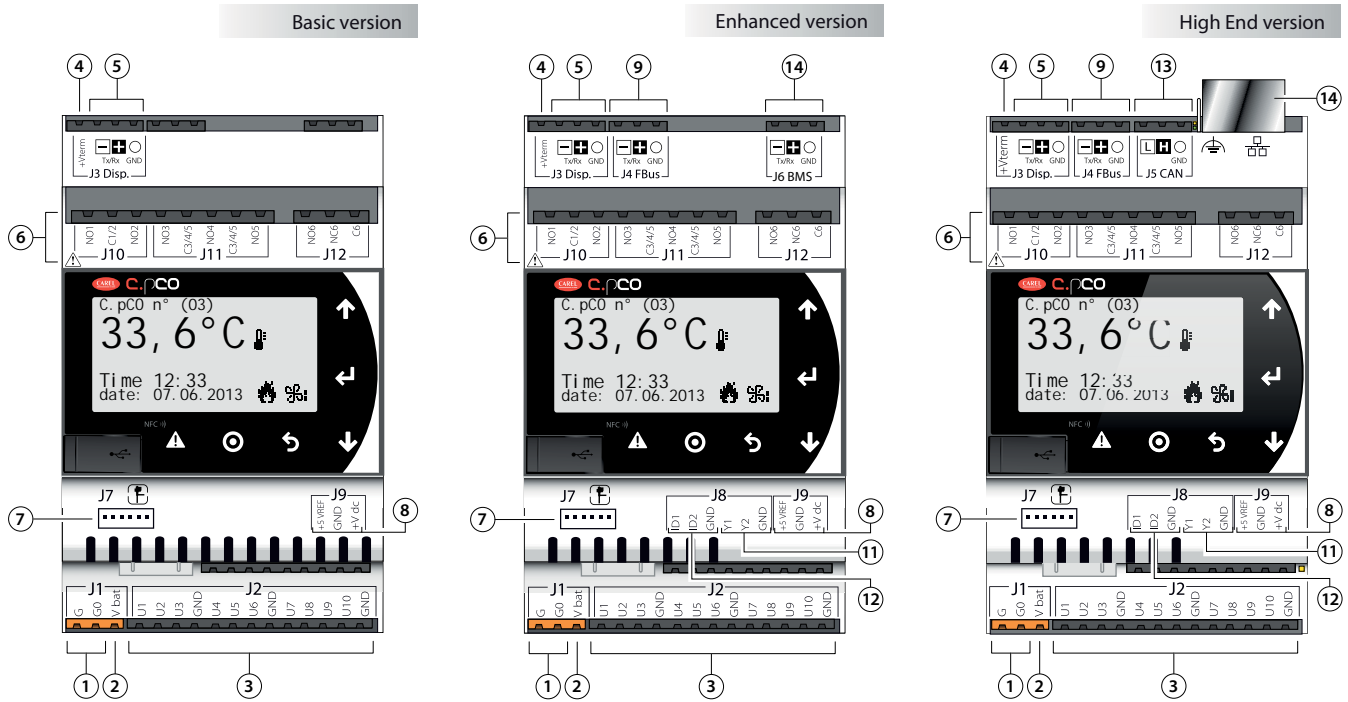

c.pCOmini - Panel version (rear view)

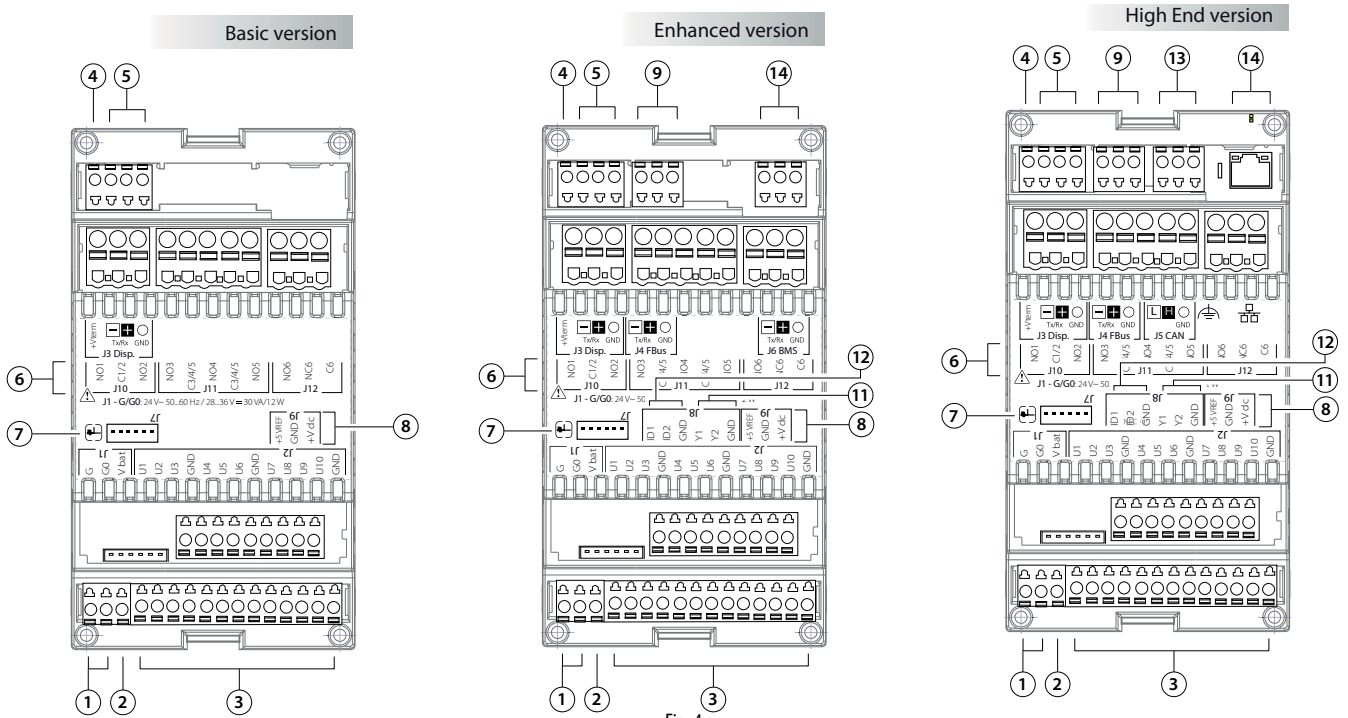

Fig. 4.5

Key:

Ref.	Description
1	Power connector [G(+), G0(-)]
2	Vbat: terminal for external Ultracap module (accessory)
3	Universal inputs/outputs
4	+Vterm: terminal power supply
5	Terminal connector
6	Relay digital outputs
7	Single-pole valve connector
8	+5VREF: power supply for ratiometric probes +VDC: power supply for active probes

Ref.	Description
9	FieldBus connector
10	BMS connector
11	Analogue outputs
12	Digital inputs
13	CANbus connector
14	Ethernet port
15	Dip-Switches (only for c.pCOe)

c.pCOe - DIN rail version

Basic version

Factory setting:
 address = not configured
 extension = no offset
 Baud Rate = 19.2 K
 protocol = Modbus

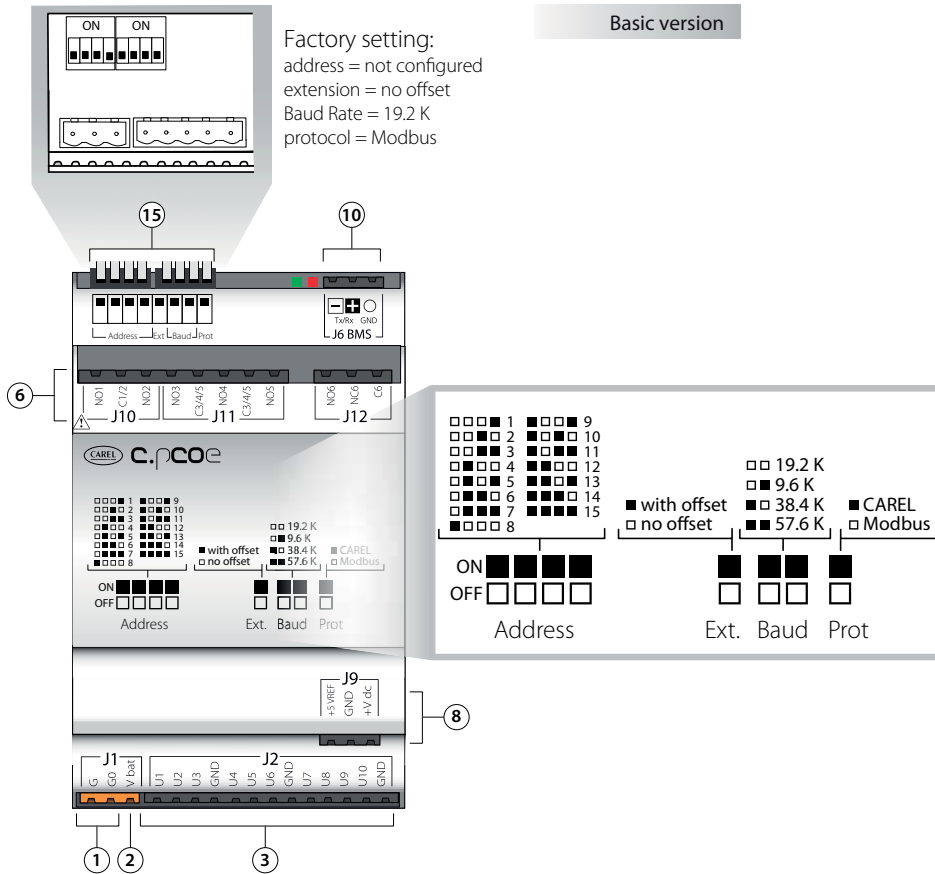

Fig. 4.t

Description of connection terminals on c.pCO mini/c.pCOe

See the figures on the previous pages relating to c.pCO mini/c.pCOe

Ref.	Term.	Label	Description
1	J1-1	G	Power supply at voltage A(*)
	J1-2	G0	Power supply reference
2	J1-3	Vbat	Power supply from external Ultracap module
3	J2-1	U1	Universal input/output 1
	J2-2	U2	Universal input/output 2
	J2-3	U3	Universal input/output 3
	J2-4	GND	Common for universal inputs/outputs 1, 2, 3
	J2-5	U4	Universal input/output 4
	J2-6	U5	Universal input/output 5
	J2-7	U6	Universal input/output 6
	J2-8	GND	Common for universal inputs/outputs 4, 5, 6
	J2-9	U7	Universal input/output 7
	J2-10	U8	Universal input/output 8
	J2-11	U9	Universal input/output 9
	J2-12	U10	Universal input/output 10
	J2-13	GND	Common for universal inputs/outputs 7, 8, 9, 10
4	J3-1	+Vterm	Power supply for additional terminal
	J3-2	Tx-/Rx-	Terminal RS485 port Tx-/Rx-
	J3-3	Tx+/Rx+	Terminal RS485 port Tx+/Rx+
	J3-4	GND	Terminal RS485 port GND
5	J10-1	NO1	Normally open contact, relay 1
	J10-2	C1/2	Common for relay 1, 2
	J10-3	NO2	Normally open contact, relay 2
	J11-1	NO3	Normally open contact, relay 3
	J11-2	C3/4/5	Common for relay 3, 4, 5
	J11-3	NO4	Normally open contact, relay 4
	J11-4	C3/4/5	Common for relay 3, 4, 5
	J11-5	NO5	Normally open contact, relay 5
	J12-1	NO6	Normally open contact, relay 6
	J12-2	NC6	Normally closed contact, relay 6
	J12-3	C6	Common for relay 6
	7	J7	-
8	J9-1	+5 VREF	Power supply ratiometric probes 0 to 5 V
	J9-2	GND	Power supply common
	J9-3	+VDC	Power to active probes

Ref.	Term.	Label	Description
9	J4-1	Tx-/Rx-	FieldBus RS485 port Tx-/Rx-
	J4-2	Tx+/Rx+	FieldBus RS485 port Tx+/Rx+
	J4-3	GND	FieldBus RS485 port GND
10	J6-1	Tx-/Rx-	BMS RS485 port Tx-/Rx-
	J6-2	Tx+/Rx+	BMS RS485 port Tx+/Rx+
	J6-3	GND	BMS RS485 port GND
11	J8-4	Y1	Analogue output 1, 0...10 V
	J8-5	Y2	Analogue output 2, 0...10 V
	J8-6	GND	Common for analogue outputs 1, 2
12	J8-1	ID1	Digital input 1
	J8-2	ID2	Digital input 2
	J8-3	GND	Common for digital inputs 1, 2
13	J5-1	TxL/RxL	CANbus port TxL/RxL
	J5-2	TxH/RxH	CANbus port TxH/RxH
	J5-3	GND	CANbus port GND

(*) Voltage A: 24 Vac o 28...36 Vdc

4.1 c.pCO Small and Medium: connection terminals

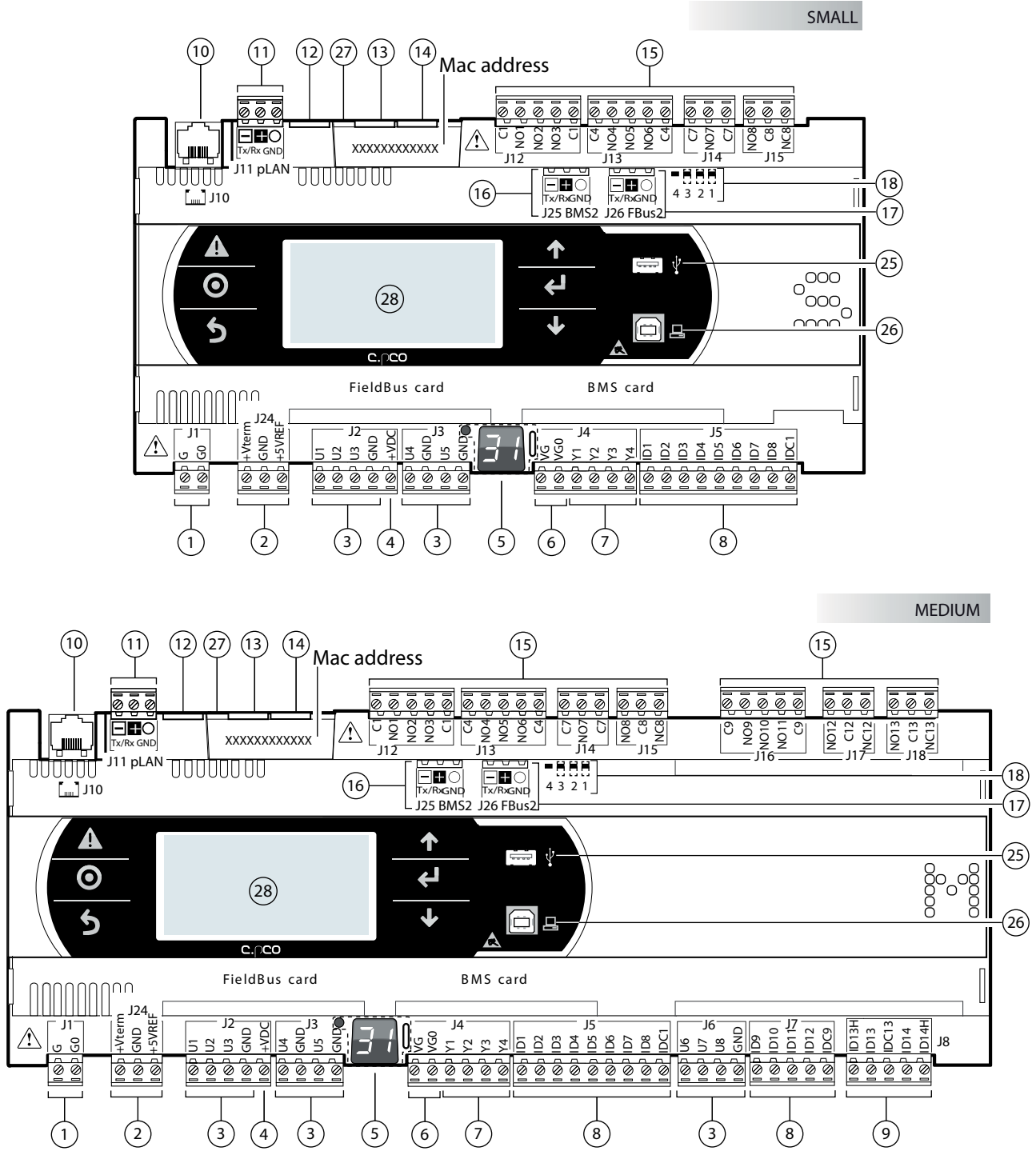

Fig. 4.u

Key:

Ref.	Description
1	Power connection [G(+), G0(-)]
2	+Vterm: power supply for additional terminal +5 VREF power supply for ratiometric probes
3	Universal inputs/outputs
4	+VDC: power supply for active probes
5	Button for setting pLAN address, second display, LED
6	VG: power supply at voltage A(*) for opto-isolated analogue output VG0: power to optically-isolated analogue output, 0 Vac/Vdc
7	Analogue outputs
8	ID: digital inputs for voltage A (*)
9	ID.: digital inputs for voltage A (*) IDH.: digital inputs for voltage B (**)
10	pLAN telephone connector for terminal
11	pLAN plug-in connector

(*) Tensione A: 24 Vac o 28...36 Vdc; (**) Tensione B: 230 Vac - 50/60 Hz.

Ref.	Description
12	Reserved
13	Ethernet port 1
14	Ethernet port 2
15	Relay digital outputs
16	BMS2 port
17	FieldBus2 port
18	Jumpers for selecting FieldBus/ BMS
25	USB Host Port (Master)
26	USB Device Port (Slave)
27	Faston for earth connection to Ethernet Port
28	Display built-in and keypad

4.9 c.pCO Large and Extralarge: connection terminals

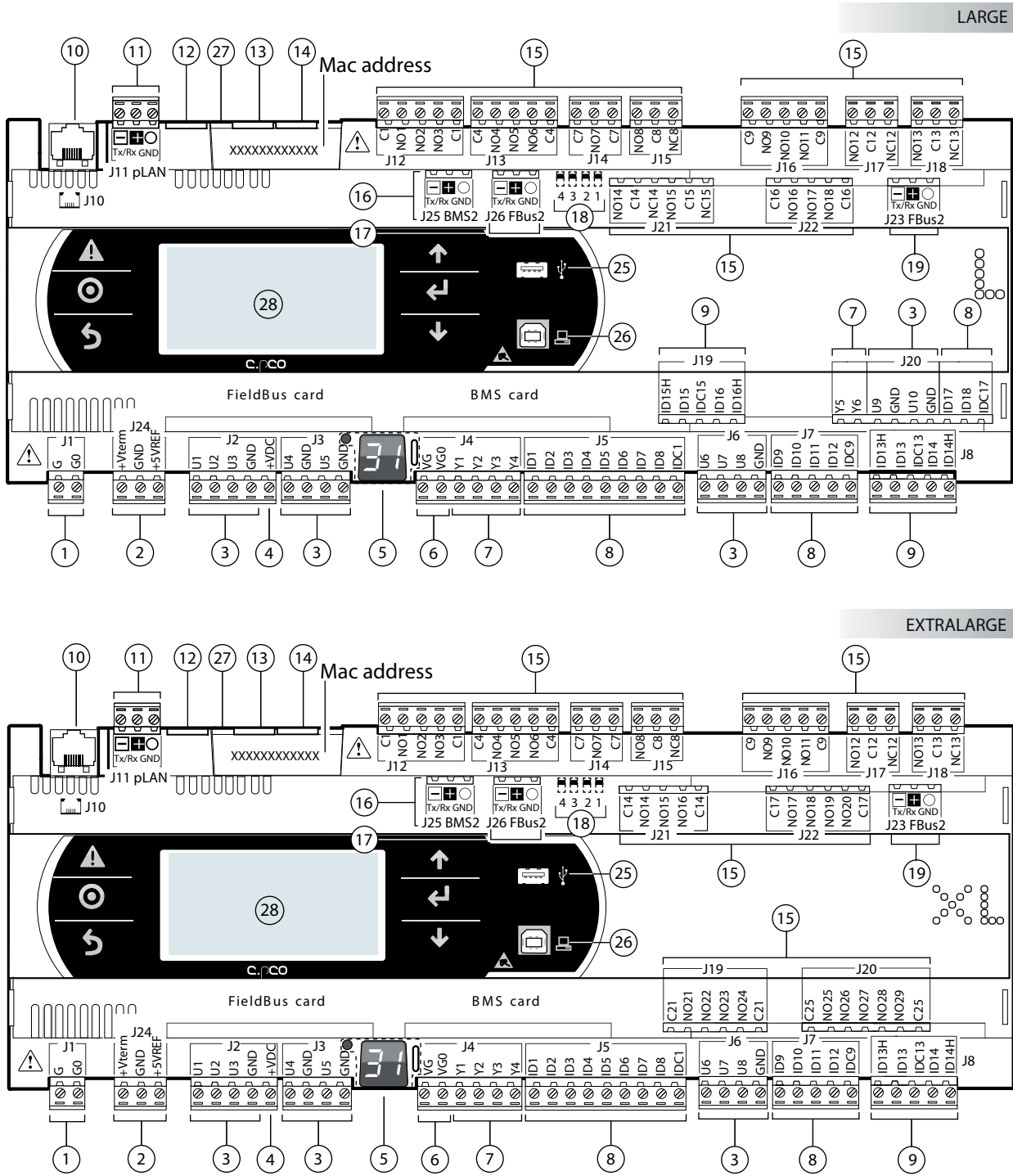

Fig. 4.v

Key:

Ref.	Description
1	Power connector [G(+), G0(-)]
2	+Vterm: power supply for additional terminal +5 VREF power supply for ratiometric probes
3	Universal inputs/outputs
4	+VDC: power supply for active probes
5	Button for setting pLAN address, second display, LED
6	VG: power supply at voltage A(*) for opto-isolated analogue output VG0: power to optically-isolated analogue output, 0 Vac/Vdc
7	Analogue outputs
8	ID: digital inputs for voltage A (*)
9	ID.: digital inputs for voltage A (*) IDH.: digital inputs for voltage B (**)
10	pLAN telephone connector for terminal/downloading application
11	pLAN plug-in connector
12	Reserved

(*) Voltage A: 24 Vac or 28-36 Vdc; (**) Voltage B: 230 Vac - 50/60 Hz.

Ref.	Description
13	Ethernet port 1
14	Ethernet port 2
15	Relay digital outputs
16	BMS2 port
17	FieldBus2 port
18	Jumpers for selecting FieldBus/ BMS
19	FieldBus2 port
25	USB Host Port (Master)
26	USB Device Port (Slave)
27	Faston for earth connection to Ethernet Port
28	Display built-in and keypad

4.2 c.pCO built-in driver: connection terminals

Two models of c.pCO are available with one or two built-in electronic expansion valve drivers.

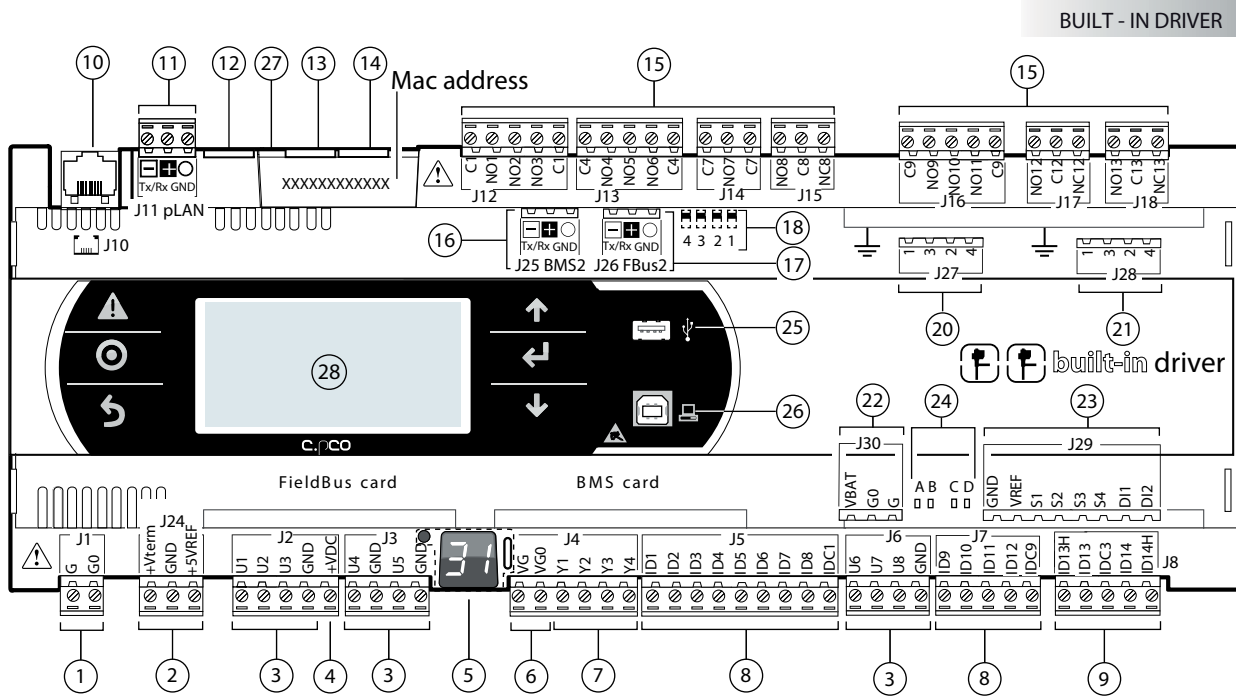

Fig. 4.w

Key:

Ref.	Description	Ref.	Description
1	Power connector [G(+), G0(-)]	15	Relay digital outputs
2	+Vterm: power supply for additional terminal +5 VREF power supply for ratiometric probes	16	BMS2 port
3	Universal inputs/outputs	17	FieldBus2 port
4	+VDC: power supply for active probes	18	Jumpers for selecting FieldBus/ BMS
5	Button for setting pLAN address, second display, LED	20	Electronic valve A connector
6	VG: power supply at voltage A(*) for opto-isolated analogue output VG0: power to optically-isolated analogue output, 0 Vac/Vdc	21	Electronic valve B connector
7	Analogue outputs	22	Connector for external Ultracap module (accessory)
8	ID: digital inputs for voltage A (*)	23	Valve driver analogue and digital inputs
9	ID.: digital inputs for voltage A (*) IDH.: digital inputs for voltage B (**)	24	Valve status indicator LED
10	pLAN telephone connector for terminal	25	USB Host Port (Master)
11	pLAN plug-in connector	26	USB Device Port (Slave)
12	Reserved	27	Faston for earth connection to Ethernet Port
13	Ethernet port 1	28	Display built-in and keypad
14	Ethernet port 2		

(*) Voltage A: 24 Vac or 28-36 Vdc; (**) Voltage B: 230 Vac - 50/60 Hz.

Description of connection terminals on c.pCO Small... Extralarge

Ref.	Term.	Label	Description
1	J1-1	G	Power supply at voltage A(*)
	J1-2	G0	Power supply reference
2	J24-1	+Vterm	Additional power supply terminal
	J24-2	GND	Power supply common
	J24-3	+5 VREF	Power supply ratiometric probes 0 to 5 V
3	J2-1	U1	Universal input/output 1
	J2-2	U2	Universal input/output 2
	J2-3	U3	Universal input/output 3
	J2-4	GND	Common for universal inputs/outputs 1, 2, 3
3	J3-1	U4	Universal input/output 4
	J3-2	GND	Common for universal input/output 4
	J3-3	U5	Universal input/output 5
	J3-4	GND	Common for universal input/output 5
3	J6-1	U6	Universal input/output 6
	J6-2	U7	Universal input/output 7
	J6-3	U8	Universal input/output 8
	J6-4	GND	Common for universal inputs/outputs 6, 7, 8

Ref.	Term.	Label	Description
3	J20-3 ♦	U9	Universal input/output 9
	J20-4 ♦	GND	Common for universal input/output 9
	J20-5 ♦	U10	Universal input/output 10
4	J20-6 ♦	GND	Common for universal input/output 10
	J2-5	+VDC	Power to active probes
5	Button for setting pLAN address, secondary display, LED		
6	J4-1	VG	Power to optically-isolated analogue output, voltage A(*)
	J4-2	VG0	Power to optically-isolated analogue output, 0 Vac/Vdc
7	J4-3	Y1	Analogue output 1, 0 to 10 V
	J4-4	Y2	Analogue output 2, 0 to 10 V
	J4-5	Y3	Analogue output 3, 0 to 10 V
	J4-6	Y4	Analogue output 4, 0 to 10 V
7	J20-1 ♦	Y5	Analogue output 5, 0 to 10 V
	J20-2 ♦	Y6	Analogue output 6, 0 to 10 V

Ref.	Term.	Label	Description
8	J5-1	ID1	Digital input 1 at voltage A(*)
	J5-2	ID2	Digital input 2 at voltage A(*)
	J5-3	ID3	Digital input 3 at voltage A(*)
	J5-4	ID4	Digital input 4 at voltage A(*)
	J5-5	ID5	Digital input 5 at voltage A(*)
	J5-6	ID6	Digital input 6 at voltage A(*)
	J5-7	ID7	Digital input 7 at voltage A(*)
	J5-8	ID8	Digital input 8 at voltage A(*)
	J5-9	IDC1	Common for digital inputs from 1 to 8 (negative pole for DC power supply)
8	J7-1	ID9	Digital input 9 at voltage A(*)
	J7-2	ID10	Digital input 10 at voltage A(*)
	J7-3	ID11	Digital input 11 at voltage A(*)
	J7-4	ID12	Digital input 12 at voltage A(*)
	J7-5	IDC9	Common for digital inputs from 9 to 12 (negative pole for DC power supply)
8	J20-7♦	ID17	Digital input 17 at voltage A(*)
	J20-8♦	ID18	Digital input 18 at voltage A(*)
	J20-9♦	IDC17	Common for digital inputs 17 and 18 (negative pole for DC power supply)
9	J8-1	ID13H	Digital input 13 at voltage B(**)
	J8-2	ID13	Digital input 13 at voltage A(*)
	J8-3	IDC13	Common for digital inputs 13 and 14 (negative pole for DC power supply)
	J8-4	ID14	Digital input 14 at voltage A(*)
	J8-5	ID14H	Digital input 14 at voltage B(**)
9	J19-1♦	ID15H	Digital input 15 at voltage B(**)
	J19-2♦	ID15	Digital input 15 at voltage A(*)
	J19-3♦	IDC15	Common for digital inputs 15 and 16 (negative pole for DC power supply)
	J19-4♦	ID16	Digital input 16 at voltage A(*)
	J19-5♦	ID16H	Digital input 16 at voltage B(**)
10	J10	-	Connector for telephone cable pLAN
11	J11-1	Tx-/Rx-	pLAN RS485 port Tx-/Rx-
	J11-2	Tx+/Rx+	pLAN RS485 port Tx+/Rx+
	J11-3	GND	pLAN RS485 port GND
12	-	-	Reserved
13	-	-	Ethernet port 1
14	-	-	Ethernet port 2
15	J12-1	C1	Common for relays 1, 2, 3
	J12-2	NO1	Normally open contact, relay 1
	J12-3	NO2	Normally open contact, relay 2
	J12-4	NO3	Normally open contact, relay 3
	J12-5	C1	Common for relay 1, 2, 3
	J13-1	C4	Common for relay 4, 5, 6
	J13-2	NO4	Normally open contact, relay 4
	J13-3	NO5	Normally open contact, relay 5
	J13-4	NO6	Normally open contact, relay 6
	J13-5	C4	Common for relay 4, 5, 6
	J14-1	C7	Common for relay 7
	J14-2	NO7	Normally open contact, relay 7
	J14-3	C7	Common for relay 7
	J15-1	NO8	Normally open contact, relay 8
	J15-2	C8	Common for relay 8
	J15-3	NC8	Normally closed contact 8
	J16-1	C9	Common for relay 9, 10, 11
	J16-2	NO9	Normally open contact, relay 9
	J16-3	NO10	Normally open contact, relay 10
	J16-4	NO11	Normally open contact, relay 11
	J16-5	C9	Common for relay 9, 10, 11
	J17-1	NO12	Normally open contact, relay 12
	J17-2	C12	Common for relay 12
	J17-3	NC12	Normally closed contact 12
	J18-1	NO13	Normally open contact, relay 13
	J18-2	C13	Common for relay 13
	J18-3	NC13	Normally closed contact 13
	J21-1♦	NO14	Normally open contact, relay 14
	J21-2♦	C14	Common for relay 14
	J21-3♦	NC14	Normally closed contact 14
	J21-4♦	NO15	Normally open contact, relay 15
	J21-5♦	C15	Common for relay 15
	J21-6♦	NC15	Normally closed contact 15
J22-1♦	C16	Common for relay 16, 17, 18	
J22-2♦	NO16	Normally open contact, relay 16	
J22-3♦	NO17	Normally open contact, relay 17	
J22-4♦	NO18	Normally closed contact 18	
J22-5♦	C16	Common for relay 16, 17, 18	
J21-1♦♦	C14	Common for relay 14, 15, 16	
J21-2♦♦	NO14	Normally open contact, relay 14	
J21-3♦♦	NO15	Normally open contact, relay 15	
J21-4♦♦	NO16	Normally open contact, relay 16	
J21-5♦♦	C14	Common for relay 14, 15, 16	

Ref.	Term.	Label	Description
15	J22-1♦♦	C17	Common for relay 17, 18, 19, 20
	J22-2♦♦	NO17	Normally open contact, relay 17
	J22-3♦♦	NO18	Normally open contact, relay 18
	J22-4♦♦	NO19	Normally open contact, relay 19
	J22-5♦♦	NO20	Normally open contact, relay 20
	J22-6♦♦	C17	Common for relay 17, 18, 19, 20
	J19-1♦♦	C21	Common for relay 21, 22, 23, 24
	J19-2♦♦	NO21	Normally open contact, relay 21
	J19-3♦♦	NO22	Normally open contact, relay 22
	J19-4♦♦	NO23	Normally open contact, relay 23
	J19-5♦♦	NO24	Normally open contact, relay 24
	J19-6♦♦	C21	Common for relay 21, 22, 23, 24
	J20-1♦♦	C25	Common for relay 25, 26, 27, 28, 29
	J20-2♦♦	NO25	Normally open contact, relay 25
	J20-3♦♦	NO26	Normally open contact, relay 26
J20-4♦♦	NO27	Normally open contact, relay 27	
J20-5♦♦	NO28	Normally open contact, relay 28	
J20-6♦♦	NO29	Normally open contact, relay 29	
J20-7♦♦	C25	Common for relay 25, 26, 27, 28, 29	
16	J25-1	Tx-/Rx-	Tx-/Rx- RS485 BMS2 port
	J25-2	Tx+/Rx+	Tx+/Rx+ RS485 BMS2 port
	J25-3	GND	GND RS485 BMS2 port
17	J26-1	Tx-/Rx-	Tx-/Rx- RS485 Fieldbus 2 port
	J26-2	Tx+/Rx+	Tx+/Rx+ RS485 Fieldbus 2 port
18	Port J26 configuration micrositches		
19	J23-1	Tx-/Rx-	Tx-/Rx- Fieldbus 2 RS485 port
	J23-2	Tx+/Rx+	Tx+/Rx+ Fieldbus 2 RS485 port
	J23-3	GND	GND RS485 port network Fieldbus 2

For pCO5+ built-in driver only:

20	J27-1	1	Electronic expansion valve 1 control (see par. "Electronic valve connection").
	J27-2	3	
	J27-3	2	
	J27-4	4	
21	J28-1	1	Electronic expansion valve 2 control (see par. "Electronic valve connection").
	J28-2	3	
	J28-3	2	
	J28-4	4	
22	J30-1	VBAT	Power supply from external Ultracap module
	J30-2	G0	
	J30-3	G	
23	J29-1	GND	Common probe power supply
	J29-2	VREF	Probe driver power supply
	J29-3	S1	Probe 1
	J29-4	S2	Probe 2
	J29-5	S3	Probe 3
	J29-6	S4	Probe 4
	J29-7	DI1	Digital input 1
	J29-8	DI2	Digital input 2
24	A, B	Valve A status LED	
	C, D	Valve B status LED	

Tab. 4.c

(*): voltage A: 24 Vac or 28...36 Vdc;

(**): voltage B: 230 Vac - 50/60 Hz.

♦: Large model; ♦♦: Extralarge model

5. INPUT/OUTPUT CONNECTIONS

5.1 Power supply

The figure below shows the power supply connection diagram. Use a class II safety isolation transformer with short-circuit and overload protection. See the Technical Specifications table for information on the size of the transformer required by each model (see chap. 13).

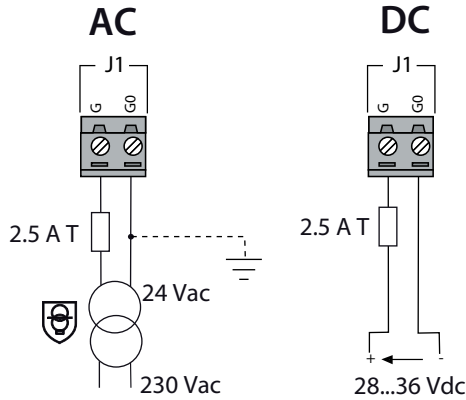

Fig. 5.a

! Important:

- power the c.pCO built-in driver with AC voltage only, with the transformer secondary winding earthed;
- if the Ethernet connection is featured and used, the transformer secondary must be earthed;
- using a supply voltage other than specified can seriously damage the controller;
- if the transformer secondary is earthed, make sure that the earth conductor is connected to terminal G0. This applies to all the devices connected to the c.pCO through a serial network;
- if more than one c.pCO board is connected to a pLAN network, make sure that the G and G0 references are observed (G0 must be maintained for all controllers);
- the power supply to the controller(s) and the terminal(s) should be kept separate from the power supply to the other electrical devices (contactors and other electromechanical components) inside the electrical panel.

➡ Note:

- when the controller is powered, the yellow LED lights up;
- refer to the diagrams in par. 4.4 in case of controllers connected to a pLAN network and installed in the same electrical panel or in separate panels.

5.2 Universal inputs/outputs

Universal inputs/outputs are distinguished by the letter U... They can be configured from the application program for many different uses, such as the following:

- passive temperature probes: NTC, PTC, PT100, PT500, PT1000;
- active pressure/temperature/humidity probes;
- ratiometric pressure probes;
- current inputs, 0 to 20 mA or 4 to 20 mA;
- voltage inputs, 0 to 1 Vdc or 0 to 10 Vdc;
- voltage-free contact digital inputs and fast digital inputs;
- analogue outputs, 0 to 10 Vdc;
- PWM outputs.

! Important:

- the universal inputs/outputs must be pre-configured to handle their respective signals from the application program;
- the universal inputs/outputs cannot be used as digital outputs.

Max. number of connectable analogue inputs

The maximum number of analogue inputs that can be connected to the universal inputs/outputs depends on the type used.

Type of signal	Maximum number of inputs connectable to universal inputs/outputs c.pCO			
	mini - c.pCOe	Small	Medium/ Built-in driver/ Extralarge	Large
- NTC/PTC/PT500/PT1000 probes	10	5	8	10
- PT100 probes	max 5	2	3 (2 on U1...U5, 1 on U6...U8)	4 (2 on U1...U5, 1 on U6...U8, 1 on U9...U10)
- 0 to 1 Vdc/0 to 10 Vdc signals from probes powered by the controller	0	5	6	max 6
- 0 to 1 Vdc/0 to 10 Vdc signals powered externally	10	5	8	10
- 0 to 20 mA / 4 to 20 mA inputs from probes powered by the controller	max tot 4	2	4	6: (max 4 on U1...U5, 3 on U6...U8)
- 0 to 20 mA / 4 to 20 mA inputs from probes powered externally	max tot 4	4	4	7: (max 4 on U1...U5, 3 on U6...U8)
- 0 to 5 V signals from ratiometric probes powered by the controller	max 2	max 5	max 6	max 6

Tab. 5.a

➡ Note:

the table shows the maximum number of inputs that can be connected. For example, it is possible to connect to a Small size controller a maximum of five 0 to 1Vdc inputs related to probes powered by the controller, and a maximum of five 0 to 1 Vdc inputs related to probes powered externally. In any case, maximum number of 0 to 1Vdc inputs must be 5.

Remote connection of analogue inputs

The table below shows the required cable sizes to be used for the remote connection of the analogue inputs.

Type of input	Cross section for lengths <50 m (mm ²)	Cross section for lengths <100 m (mm ²)
NTC	0,5	1,0
PT1000	0,75	1,5
I (current)	0,25	0,5
V (current)	0,25	0,5

Tab. 5.b

! Important:

- if the controller is installed in an industrial environment (standard EN 61000-6-2) the connections must be less than 10 m long; do not exceed this length to avoid measurement errors.
- to avoid electromagnetic interference, keep the probe and digital input cables separate from the power cables as much as possible (at least 3 cm). Never run power cables and probe signal cables in the same conduits (including the ones in the electrical panels).

Connecting NTC, PTC temperature probes

For information on the maximum number of probes that can be connected see the table at the beginning of this paragraph. For details on the operating range see the Technical Specifications table (cap. 12).

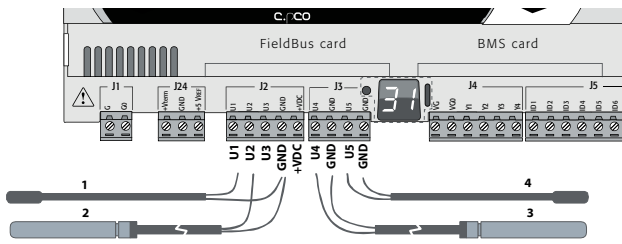

Fig. 5.b

Key

Controller terminals	NTC probe			
	1	2	3	4
GND	Wire 1			
U1	Wire 2			
GND		Wire 1		
U2		Wire 2		
GND			Wire 1	
U4			Wire 2	
GND				Wire 1
U5				Wire 2

Connecting PT500/PT1000 temperature probes

For information on the maximum number of probes that can be connected see the table at the beginning of this paragraph. For details on the operating range see the Technical Specifications table (cap. 12).

Important:

- to ensure correct measurements from the probe each wire must be connected to only one terminal.
- the two probe wires have no polarity.

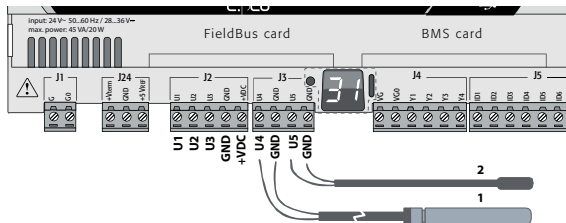

Fig. 5.c

Key

Controller terminals	PT500/PT1000 probe	
	1	2
GND	Wire 1	
U4	Wire 2	
GND		Wire 1
U5		Wire 2

Connecting PT100 temperature probes

For information on the maximum number of probes that can be connected see the table at the beginning of this paragraph. For details on the operating range see the Technical Specifications table (see chap. 12). The probe has three wires: connect one to GND and the other two to two separate but adjacent universal inputs on the same controller (e.g. U1, U2, GND, or U4, U5, GND).

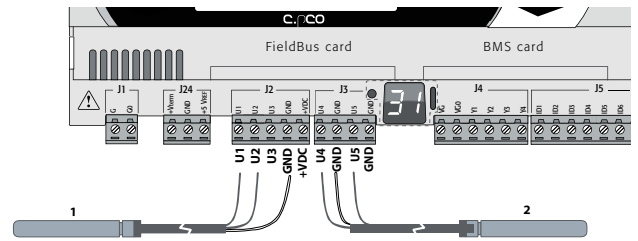

Fig. 5.d

Key

Controller terminals	PT100 probe	
	1	2
U1	Wire 1 (red)	
U2	Wire 2 (red)	
GND	Wire 3 (white)	
U4		Wire 1 (red)
U5		Wire 2 (red)
GND		Wire 3 (white)

Connecting active temperature and humidity probes

For information on the maximum number of probes that can be connected see the table at the beginning of this paragraph. The number depends on the power supply used. The distinction is between probes powered by the controller (terminal +VDC) and probes powered by an external source, and also between active probes with voltage or current outputs. For details on the operating range see the data sheets supplied with the probes. The controller can be connected to all the CAREL DP* series active temperature and humidity probes configured for 0 to 1 V or 4 to 20 mA.



Note: in c.p.COmini models it is not possible to manage 0 to 1 Vdc or 0 to 10 Vdc signals coming from probes powered directly by the controller.



Important: for temperature probes use the 4 to 20 mA or NTC configuration, cause 0 to 1 Vdc signal is limited to the 0 to 1 V range and is therefore not always compatible with the standard 10 mV/°C signal of CAREL probes (at temperatures below 0 °C or above 100 °C a probe alarm may be activated).

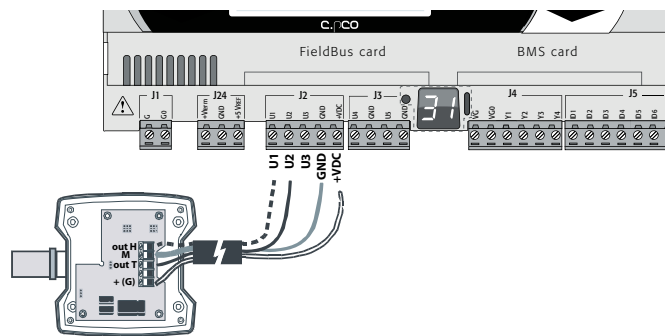

Fig. 5.e

Key

Controller terminals	Probe terminals	Description
GND	M	Reference
+VDC	+(G)	Probe power supply
U1	outH	Humidity probe output
U2	outT	Temperature probe output

Connecting current-output pressure probes

For information on the maximum number of probes that can be connected see the table at the beginning of this paragraph. For details on the operating range see the data sheets supplied with the probes. The controller can be connected to all CAREL SPK* series active pressure probes or any commercially available pressure probes with 0 to 20 mA or 4 to 20 mA signals.

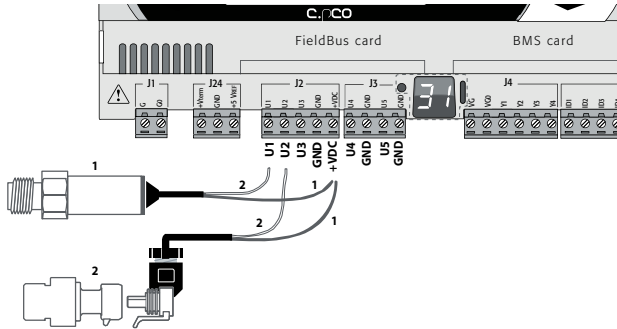

Fig. 5.f

Key	
Controller terminals	Current-output pressure probe
+VDC	Wire 1 power brown Wire 2 power brown
U1	Wire 2 Signal white -
U2	Wire 2 Signal white

Connecting 0 to 5 V ratiometric pressure probes

For information on the maximum number of probes that can be connected see the table at the beginning of this paragraph. For details on the operating range see the probe data sheets. The controller can be connected to all CAREL SPKT series active pressure probes or any commercially available pressure probes with 0 to 5 V ratiometric signals.

Important:

- ratiometric probes are powered by the controller via terminal +5 VREF;
- ratiometric probes cannot be powered by an external source.

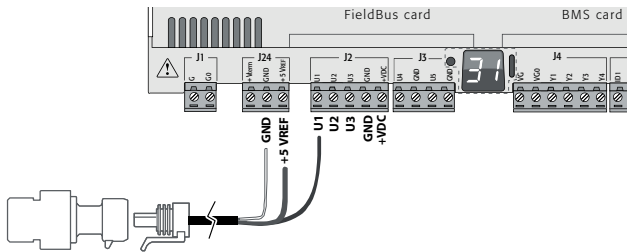

Fig. 5.g

Key		
Controller terminals	Description	Wire colour
+5 Vref	Power	black
GND	Power reference	green
U1	Signal	white

Connecting active probes with 0 to 10 V output

For information on the maximum number of probes that can be connected see the table at the beginning of this paragraph. For details on the operating range see the data sheets supplied with the probes.

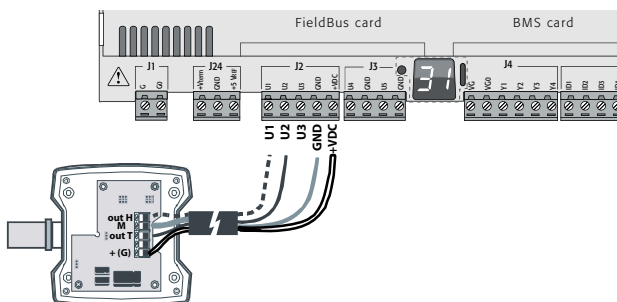

Fig. 5.h

Key	
Controller terminals	Active probes with 0 to 10 V output
GND	Reference
+VDC	Power
U1	Signal 1
U2	Signal 2

Max. number of connectable digital inputs

The controller allows the universal inputs/outputs to be configured as non-optically isolated, voltage-free digital inputs. In any case, the inputs must be connected to a voltage-free contact.

Type of signal		Maximum number of dig. inputs connectable to universal inputs/outputs			
		c.pCO			
		mini	Small	Medium/ Built-in driver/ Extralarge	Large
Digital inputs (not opto-isolated)	- volt-free contacts	10	5	8	10
	- fast inputs	max 2	max 2	4 (max 2 on U1...U5, max 2 on U6..U8)	6 (max 2 on U1...U5, max 2 on U6...U8, 2 on U9...U10)

Tab. 5.c

Important: the maximum current allowed on the digital input is 10 mA. Therefore the rating of the external contact must be at least 10 mA.

Connecting ON/OFF inputs

There is no particular restriction on the maximum number of inputs that can be connected. For details on the operating range see the Technical Specifications table (see chap. 12).

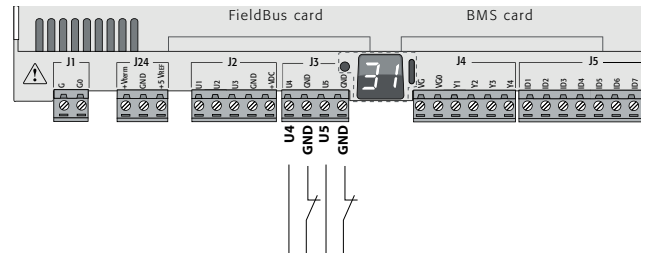

Fig. 5.i

Key	
Controller terminals	Description
U4	Digital input 1
GND	
U5	Digital input 2
GND	

Connecting fast digital inputs

Important: the wires connecting the fast digital inputs/counters must be shielded to avoid causing electromagnetic interference with the probe cables.

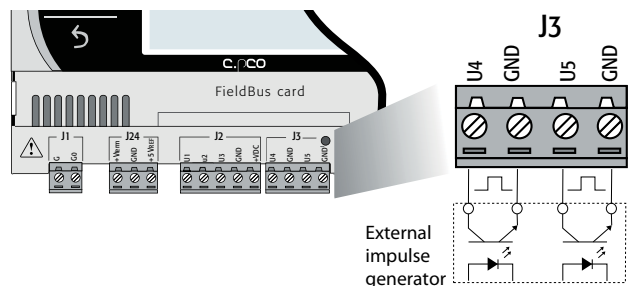

Fig. 5.j

The fast digital input can be used as a frequency meter. The count is performed on the rising edge of the pulse. The pulse generator device will have one digital output with transistor optocoupler, which will be connected to the input as shown in the figure. For details on the input signal see the Technical Specifications table (see chap. 12).

Note: the application program shows the frequency values using specific variables. If the inputs are configured as counters, the counter is reset by the application program.

Example:

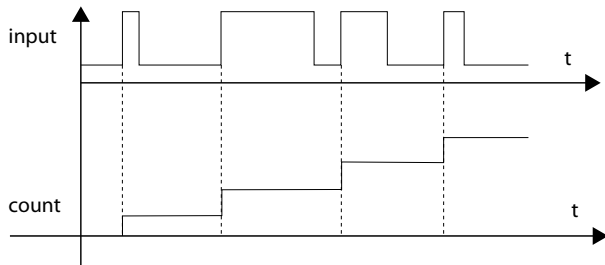

Fig. 5.k

Note: in the case of fans with current output and high series resistance, the reading of the pulses may depend on the current. The current value can be configured in the c.design I/O Editor.

Connecting non-optically-isolated analogue outputs

There is no particular restriction on the number of outputs that can be connected. For details on the output signal see the Technical Specifications table (see chap. 12).

Example: analogue/PWM output connection diagram.

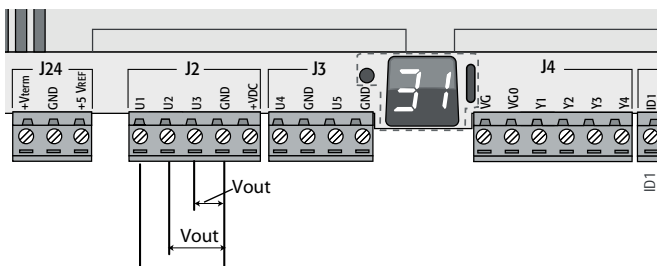

Fig. 5.l

Controller terminals	Description
U1	Analogue output 1
GND	
U2	Analogue output 2
GND	
U3	Analogue output 3
GND	

Note: the analogue outputs cannot be connected in parallel.

5.3 Digital inputs

The controller features digital inputs for connecting safety devices, alarms, device status indicators and remote switches. See the table of technical specifications for the maximum cable length cables (see chap. 12).

c.pCOmini

The digital inputs are not optically-isolated and have voltage-free contacts. The following figure shows how to connect the digital inputs:

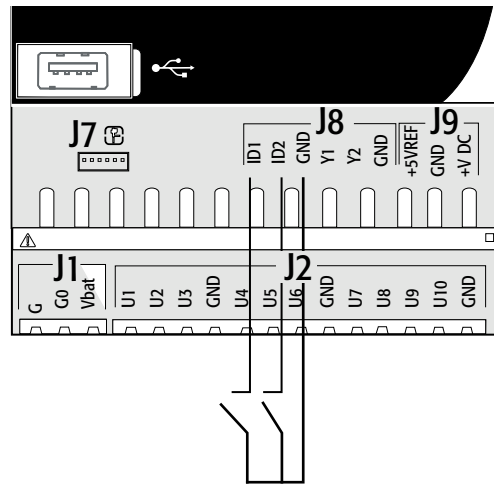

Fig. 5.m

c.pCO Small...Extralarge

These inputs are all optically isolated from the other terminals. They can work at 24 Vac (+10/-15%) or 28 to 36 Vdc (-20/+10%) (indicated as ID*), and some at 230 Vac (indicated as IDH*), see as reference figure below.

Note:

- if the control voltage is drawn in parallel with a coil, install a dedicated RC filter in parallel with the coil (typical ratings are 100 Ω, 0.5 μF, 630 V);
- if the digital inputs are connected to safety systems (alarms), the presence of voltage across the contact should be taken as the normal operating condition, while no voltage represents an alarm situation. This will ensure that any interruption (or disconnection) of the input will also be signalled;
- do not connect the neutral in place of an open digital input;
- always interrupt the phase.

Important:

- to avoid electromagnetic interference, keep the probe and digital input cables separate from the power cables as much as possible (at least 3 cm). Never run power cables and probe signal cables in the same conduits (including the ones in the electrical panels).

24 Vac digital inputs (c.pCO Small... Extralarge only)

Digital inputs ID... can be controlled at 24 Vac.

Note:

- the digital inputs are only functionally isolated from the rest of the controller;
- to keep the digital inputs optically isolated a separate power supply is needed for each input;
- the digital inputs can be powered at a different voltage from the rest of the controller.

Cable cross-section

For remote connections to the digital inputs (length <50 m), use cables with a cross-section = 0.25 (mm²)

Important: If the controller is installed in an industrial environment (standard EN 61000-6-2) the connections must be less than 30 m long. Do not exceed this length to avoid measurement errors.

Example of connection diagram (LARGE model):

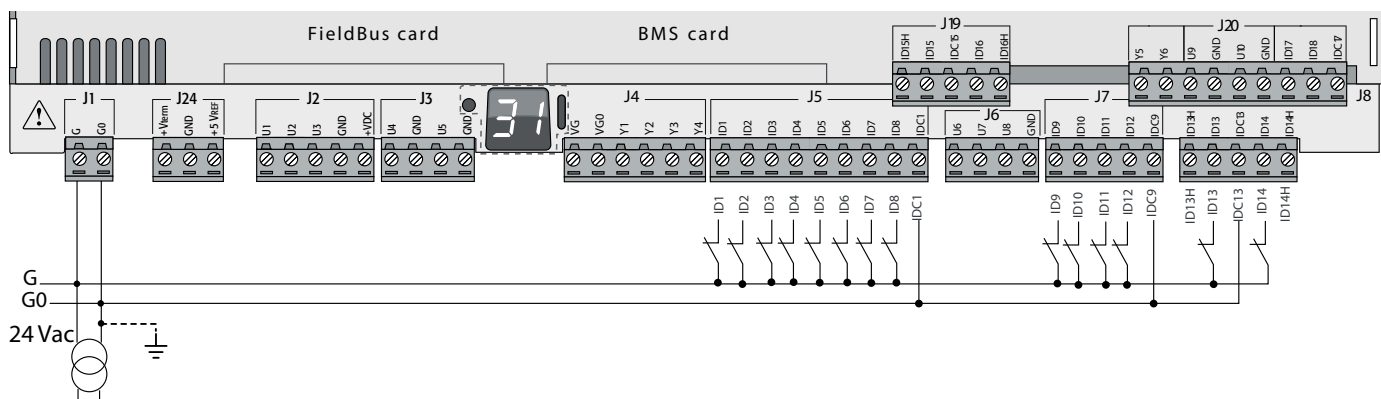

Fig. 5.n

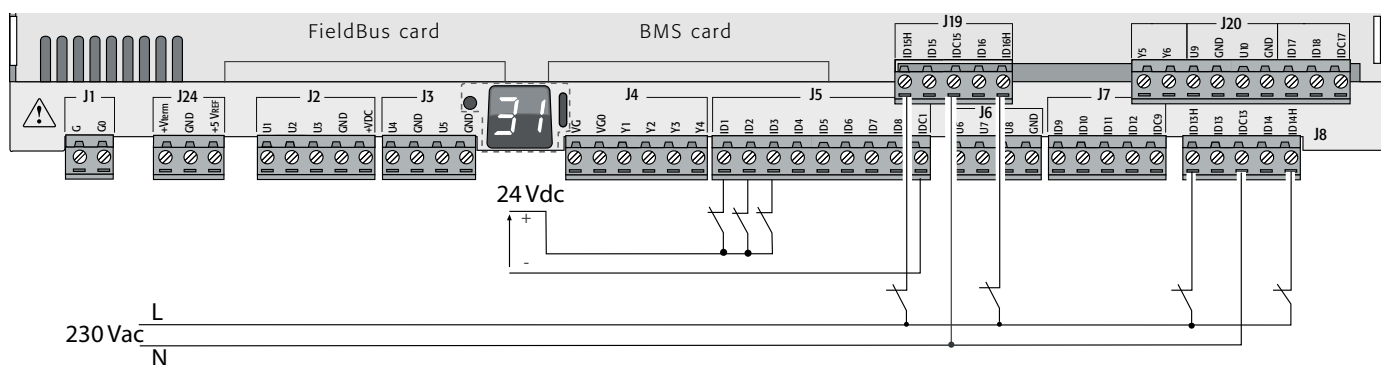

Fig. 5.o

24 Vdc digital inputs

The ID... digital inputs can be controlled at 24 Vdc.

Example of connection diagram (LARGE model):

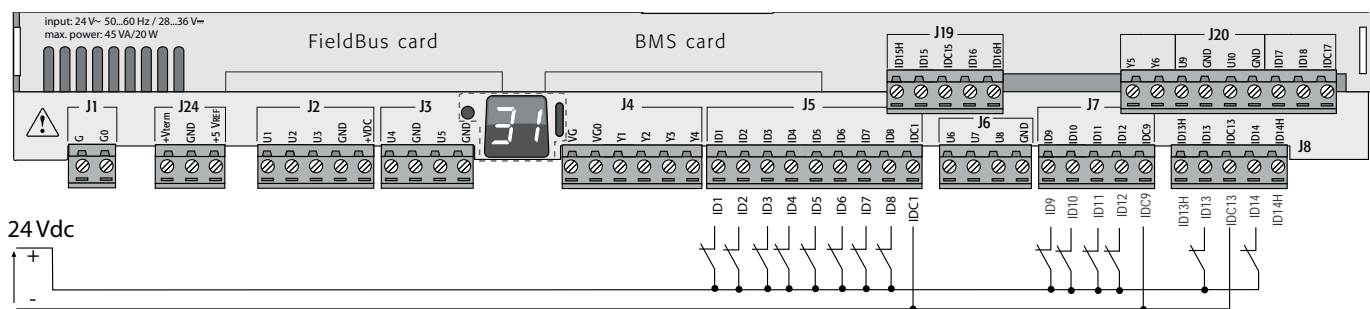

Fig. 5.p

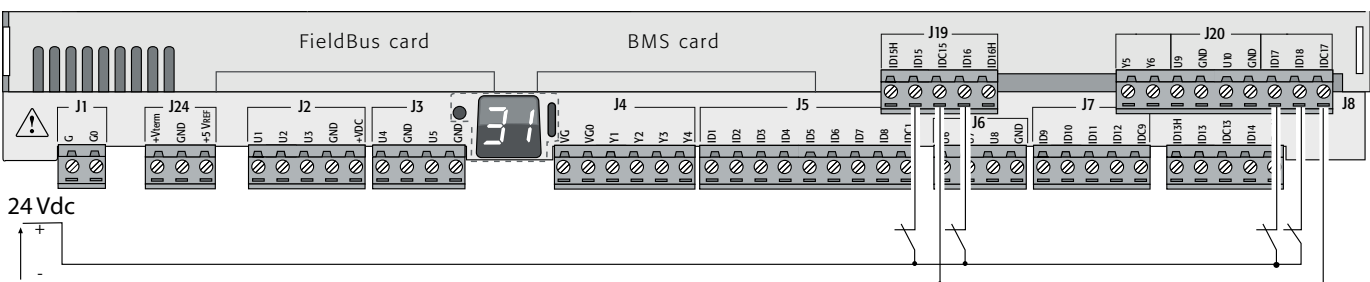

Fig. 5.q

230 Vac digital inputs (c.pCO Medium...Extralarge only)

Medium and Extralarge models feature one group of 230 Vac inputs (terminal J8), while Large models have two groups (on terminals J8 and J19). Each group consists of two digital inputs that can be powered at 230 Vac, indicated as IDH*, and two inputs that can be powered at 24 Vac/Vdc, indicated as ID*. The two groups of 230 Vac inputs have double insulation between each other and between them and the controller. The digital inputs connected may be the 24 Vac/dc inputs from one group and the 230 Vac inputs from the other. The two inputs of each group have the same common pole. Functional insulation is provided. **In each group, the digital inputs must be powered at the same voltage (24 Vac, 28 to 36 Vdc or 230 Vac) in order to avoid dangerous short-circuits and/or the risk of powering lower-voltage circuits at 230 Vac**



Note:

- the range of uncertainty of the switching threshold is from 43 to 90 Vac;
- the voltage must be 230 Vac (+10/-15%), 50/60 Hz.

Example 1: connection diagram with 230 Vac inputs.

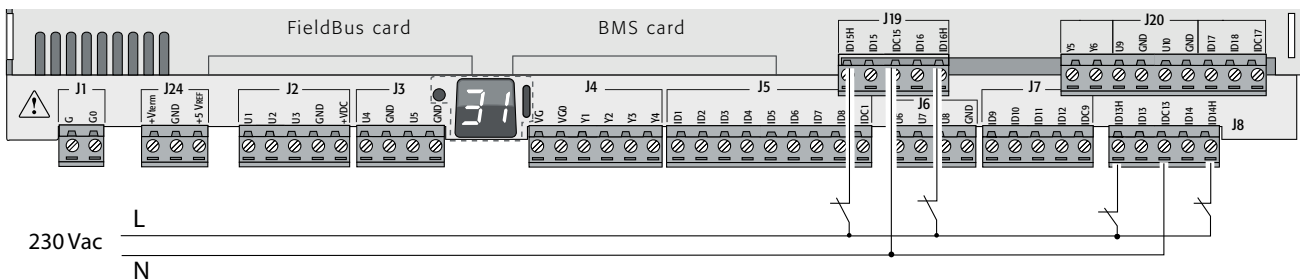

Fig. 5.r

Example 2: connection diagram with digital inputs at different voltages.

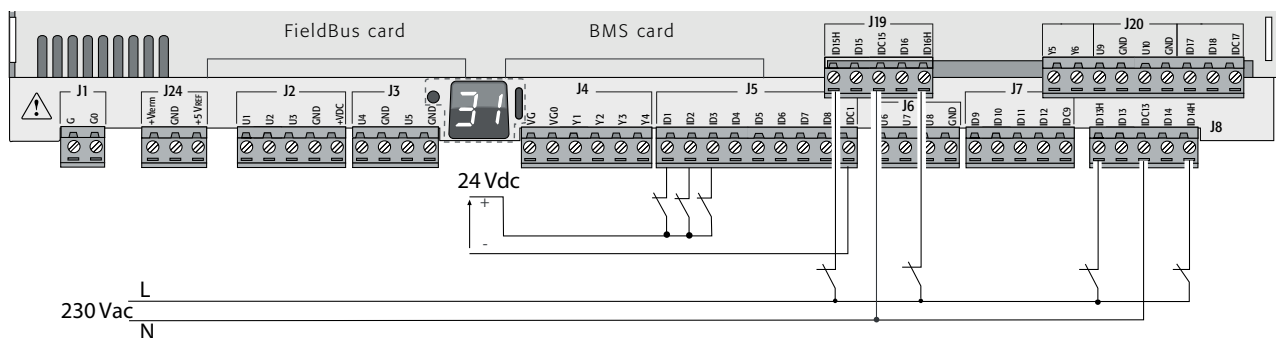

Fig. 5.s

5.4 Analogue outputs

c.pCOmini: analogue outputs without optical isolation

The controller features 0 to 10 Vdc and PWM analogue outputs without optical isolation, powered directly by the controller. See the table of the technical specifications (output current, output impedance, etc., Chap. 12).

Example connection diagram (c.pCOmini model):

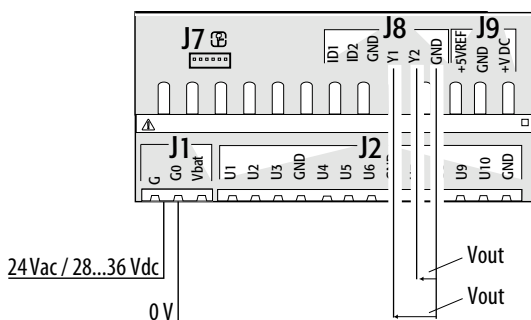

Fig. 5.t

c.pCO Small...Extralarge: 0 to 10 V analogue outputs

On terminals VG and VG0 the controller provides optically-isolated 0 to 10 V analogue outputs, to be powered externally at the same voltage as the controller, i.e. 24 Vac or 28 to 36 Vdc. The connection diagram is shown in the figure below. The 0 V supply voltage is also the voltage reference of the outputs. See the Technical Specifications table for details on the output current, output impedance, etc. (see chap. 12).

Note:

- the analogue output can be connected to the CONVONOFF0 module to convert the 0 to 10 V output into an ON/OFF relay output;
- a 0 to 10 Vdc analogue output can be connected in parallel to other outputs of the same type, or alternatively to an external voltage source. The higher voltage will be considered. Correct operation is not guaranteed if actuators with voltage inputs are connected;
- if optical isolation is not required, the VG-VG0 analogue outputs can be powered at the same voltage on G-G0: connect G0 to VG0 and G to VG.

Example connection diagram (LARGE model):

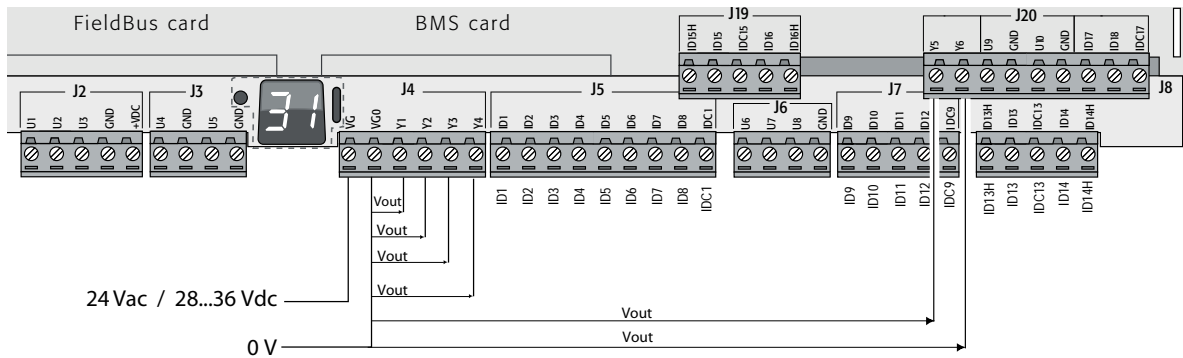

Fig. 5.u

Maximum number of optically-isolated analogue outputs (ref. VG0)

c.pCO model	Small/Medium/Extralarge	Large
Outputs	Y1, Y2, Y3, Y4	Y1, Y2, Y3, Y4, Y5, Y6

5.5 Connecting the Ultracap module

The Ultracap module can be connected to power the controllers in the event of blackouts:

1. c.pCOmini controller: the module guarantees temporary power to the **controller and driver** for enough time to close the electronic valve (40s with forced closing of the valve, 60s without forced closing of the valve). NB: with Vdc power supply, forced closing of the electronic expansion valve is not managed in the event of blackouts.

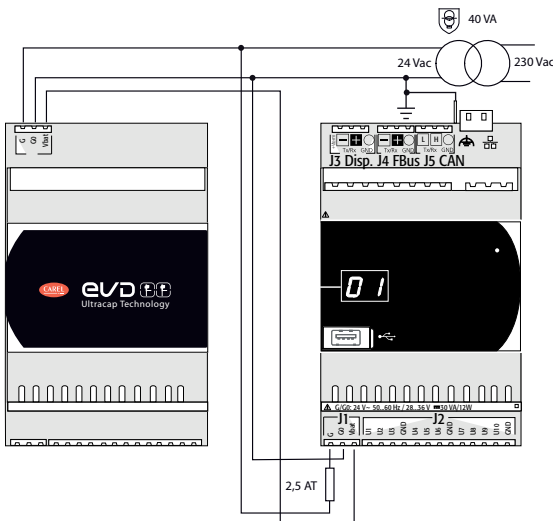

Fig. 5.v

- c.pCO controller with built-in driver: the module guarantees temporary power to the driver for enough time to close the electronic valves.

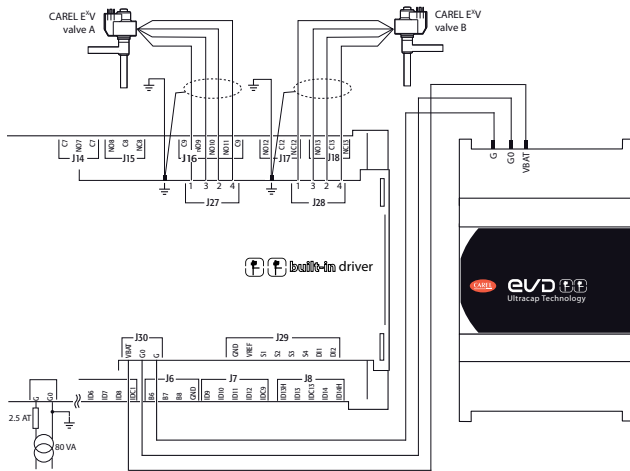

Fig. 5.w

5.6 Connecting the electronic valve

c.pCOmini: unipolar electronic valve

The controller incorporates the driver for connection of an unipolar electronic expansion valve.

- Note:** to manage the valve, the control algorithm requires 2 probes (1 pressure probe and 1 temperature probe);

Connection example using ratiometric probes (pressure) and NTC probes (temperature).

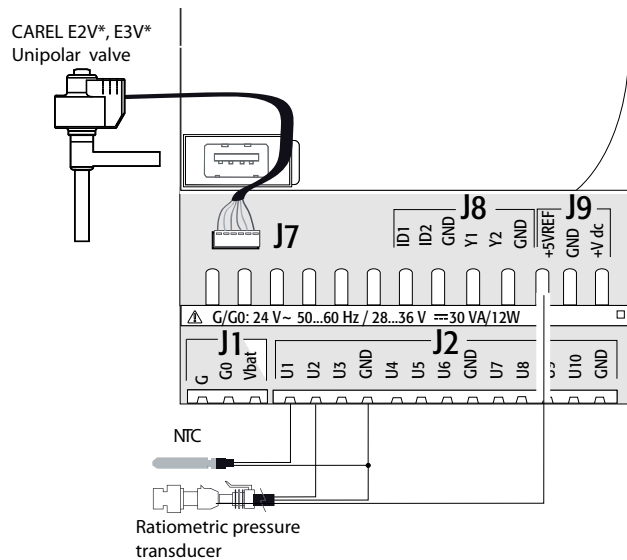

Fig. 5.x

c.pCO (Medium with built-in driver): bipolar electronic valve

The controller with a built-in driver can be used to control one or two electronic expansion valves with two-pole motor.

Example connection diagram (the colour of the wires refers to the standard Carel valve cable P/N E2VCABS*00):

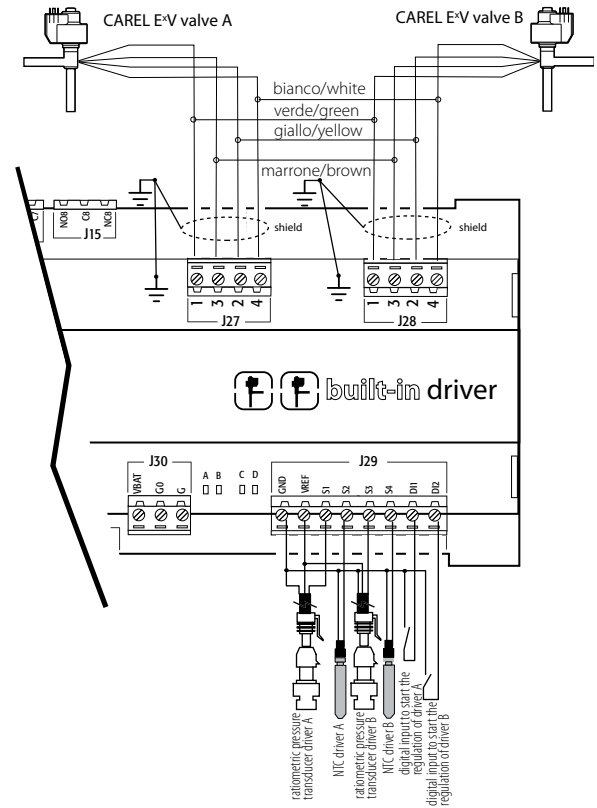

Fig. 5.y

- Note:**
- connect the valve cable shield to the spade connector and then to the earth;
 - for information on the compatibility of valves and refrigerants, see the Technical Specifications table (see chap. 12) and the EVD Evolution driver manual.

On the controller with built-in valve driver it is possible to apply the Ultracap module (accessory P/N PCOS00UC20). The module is made with special capacitors called ultracapacitors that close the electronic valve in case of power failures. The module only powers the driver and not the controller.

Important: the c.pCO with built-in driver and PCOS00UC20 module (or EVD0000UC0 external Ultracap module, or EVBAT00400 battery) must be powered at 24 Vac so that emergency valve closing is ensured in case of power failures. If the controller is powered with DC voltage it will not close the valve in case of power failures.

- Note:**
- the built-in driver replicates all the hardware and logic functions of the "EVD Evolution" stand-alone driver in case of 1 valve and of the "EVD Evolution TWIN" driver in case of 2 valves. In other words, it independently controls one or two electronic expansion valves with two-pole stepper motors. The only difference with EVD Evolution is that there are no output relays. For details on the valve control logic, set-up and installation, see the EVD Evolution manual (+0300005EN for single driver, +0300006EN for double driver);
 - as with EVD Evolution, the built-in driver on the c.pCO controller is available in the CAREL and the "Universal" versions. "Universal" models are used to control both CAREL electronic expansion valves, as well as valves produced by other manufacturers (see the Technical Specifications table, chap. 12), while CAREL models only control CAREL valves.

Serial communication and programming

Communication between the c.pCO Medium and its built-in driver is managed internally through the FBus2 serial port. The FBus2 serial port (J26) is however electrically isolated from the driver serial line; this ensures that in case of external faults on the line connected to FBus2, the internal driver can keep on working independently. The driver can only be configured using the c.pCO application developed with c.suite; no external display is available for the driver.

The c.suite development environment features a module for managing the EVD Evolution driver. When managing the built-in driver, use the module as if managing an external driver connected to the FBus2 port.

At a c.suite application software level, the valve driver must be connected to the FBus2 port. Consequently, any other devices physically connected to the Fbus2 port (J26) must have the same communication protocol (CAREL Standard Master or Modbus® Master), the same baud rate, stop bits and parity. The built-in driver address is 198 (EVD Evolution default address), so any other devices connected to J26 must have an address other than 198. Communication frame configuration is performed by using c.suite environment. External EVD Evolution drivers can be connected to the Fieldbus1 serial port (optional card) with no address restrictions.

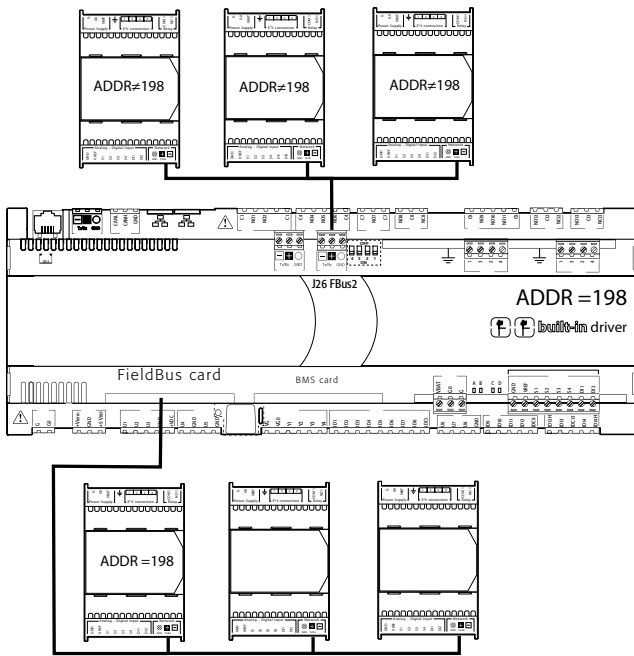

Fig. 5.z

Important: to ensure efficient data exchange between the driver and the controller, when developing the c.suite application, if there are devices connected to the FBus2 port (terminal J26) using the Modbus® protocol, developers should take into account the number of variables exchanged over the entire serial line.

5.7 Digital outputs

Electromechanical relay digital outputs

The controller features digital outputs with electromechanical relays. For ease of installation, the common terminals of some of the relays have been grouped together. Some relays feature changeover contacts.

Relays with changeover contacts

Output no.	c.pCO model			
	mini - c.pCOe	Small	Medium / Extralarge	Large
	6	8	8, 12, 13	8, 12, 13

The type of insulation is described in the table below. See also the Technical Specifications table in chap. 12.

c.pCOmini - c.pCOe

Type of insulation	
Between relays in group 1 & 2	basic insulation
Between relays in group 3 and in group 1 & 2	reinforced insulation



Note:

- between groups 1 and 2 there is basic insulation, and these must therefore have the same voltage (generally 24 Vac or 110/230 Vac);
- between the relay groups 1 and 2 and group 3 there is reinforced insulation, and so group 3 can have a different voltage.

c.pCO Small...Extralarge

Type of insulation	
Between relays in same group	functional insulation
Between groups of relays	reinforced insulation
Betw. relays and rest of controller	reinforced insulation



Note:

- inside each group, the relays have just functional insulation and must therefore have the same voltage (generally 24 Vac or 110/230 Vac);
- between groups there is reinforced insulation, so different groups can have different voltages.

Example connection diagram (LARGE model):

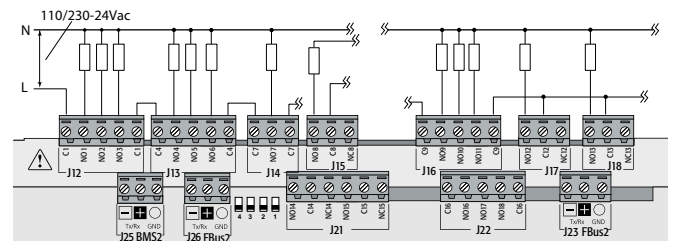

Fig. 5.a

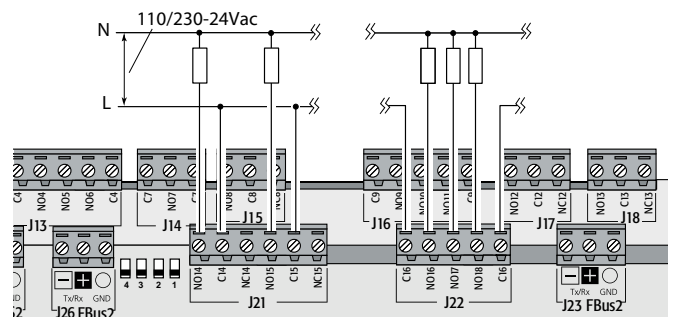

Fig. 5.ab



Important: the current on the common terminals must not exceed the capacity (rated current) of each single terminal (8 A).

Remote connection of digital outputs

The table below shows the cable sizes required according to the current.

Cross-section (mm ²)/AWG	Current (A)
0,5/20	2
1,5/15	6
2,5/14	8

Note: when different relay outputs must be operated consecutively at very close intervals (e.g. star-delta motor starter) in the order of hundreds of ms, use relays belonging to the same group, according to the following table.

c.pCOmini - c.pCOe			
relay groups for consecutive commands (~ 100 ms)			
	1	2	3
Relay	1, 2	3,4,5	6

c.pCO Small...Extralarge						
relay groups for consecutive commands (~ 100 ms)						
	1	2	3	4 - c.pCO Large	4 - c.pCO ExtraLarge	5
Relay	1, 2, 3, 4	5, 6, 7, 8	9, 10, 11, 12, 13	14, 15, 16, 17, 18	14, 15, 16, 17, 18, 19, 20, 21	22, 23, 24, 25, 26, 27, 28, 29

Important: using relays that belong to different groups can cause delays in switching.

5.8 Solid state relay (SSR) digital outputs

c.pCO controllers are also available in versions with solid-state relays (SSR) for controlling devices that require a high number of switching cycles that would not be supported by electromechanical relays. These outputs are dedicated to resistive loads powered at 224 Vac SELV or 28 to 36 Vdc SELV with max. load current up to 1 A or 230 Vac with max. load current up to 70 mA.

Example 1: connection diagram for resistive load.

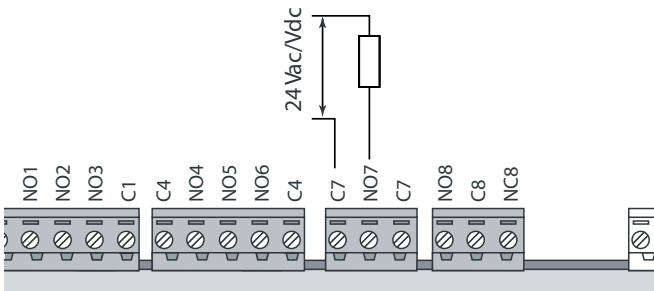

Fig. 5.ac

Example 2: connection diagram for inductive or resistive loads, with max. load current < 1 A.

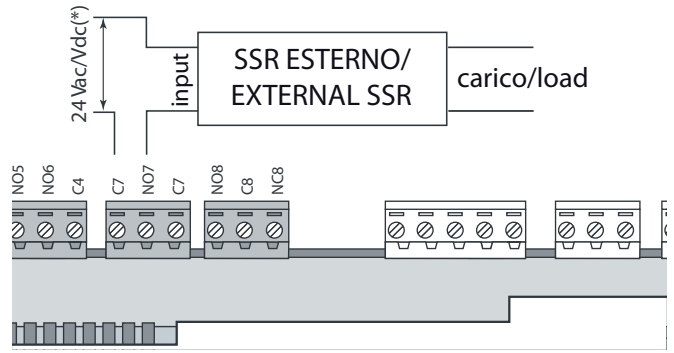

Fig. 5.ad

(*) dedicated power supply or same power supply as controller: not in common with the power supply for other external loads (e.g. contactors, coils).

Important: in applications with SSR outputs:

- the controller should only power resistive loads with load current less than maximum declared;
- use an additional external SSR to power inductive loads;
- for AC power supply to resistive loads or external SSRs, use the same power supply as the controller (connected to terminals G/G0), which must be dedicated and not in common with the power supply to other devices in the electrical panel (contactors, coils, etc.)

Note: the SSR load is powered at 24 Vac SELV, 28 to 36 Vdc SELV or 230 Vac; consequently all the other terminals in the group must be powered at the same voltage due to the absence of reinforced insulation within the group.

5.9 General connection diagram c.pCOmini

MINI

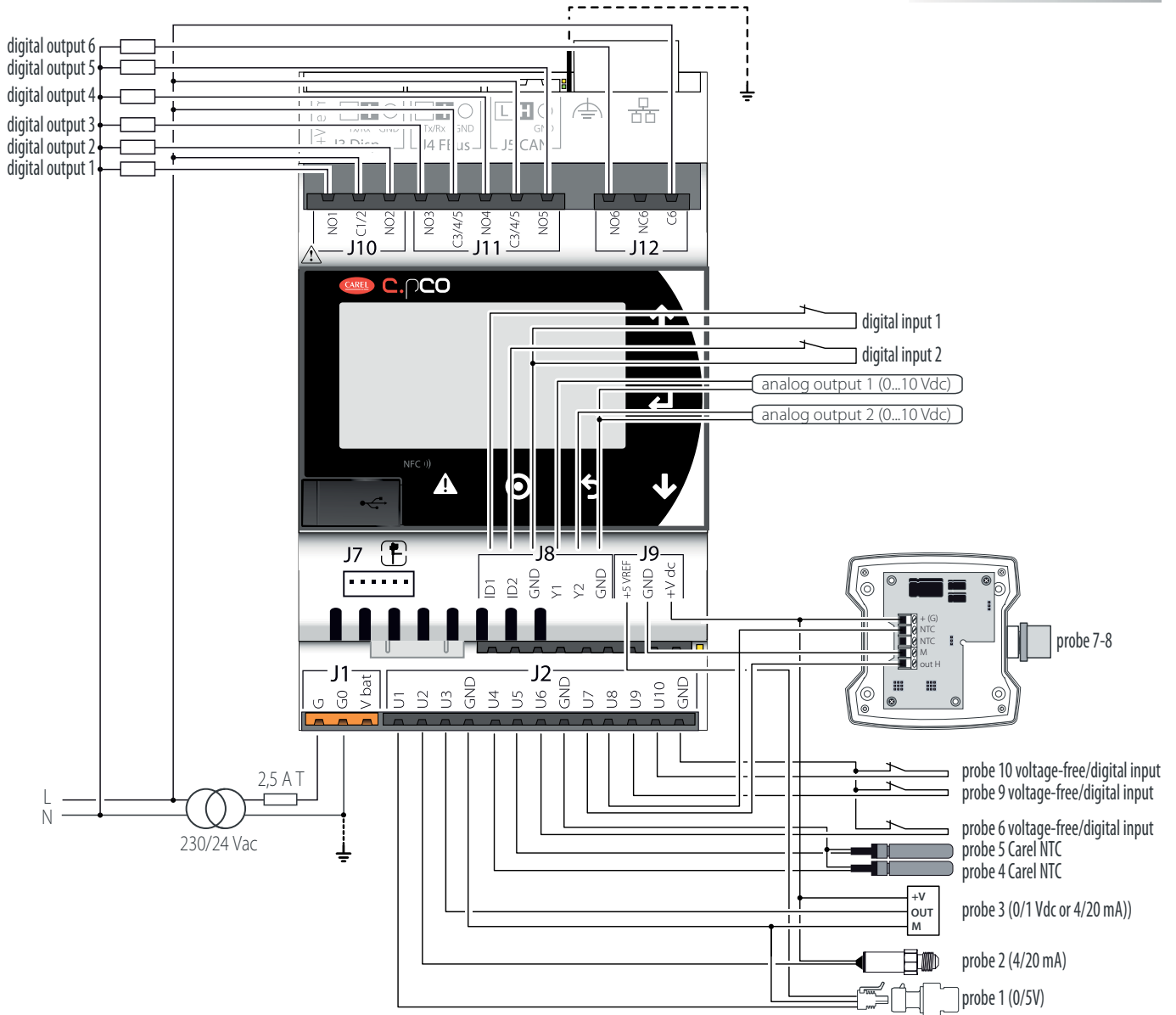

Fig. 5.ae

5.10 General connection diagram c.pCO

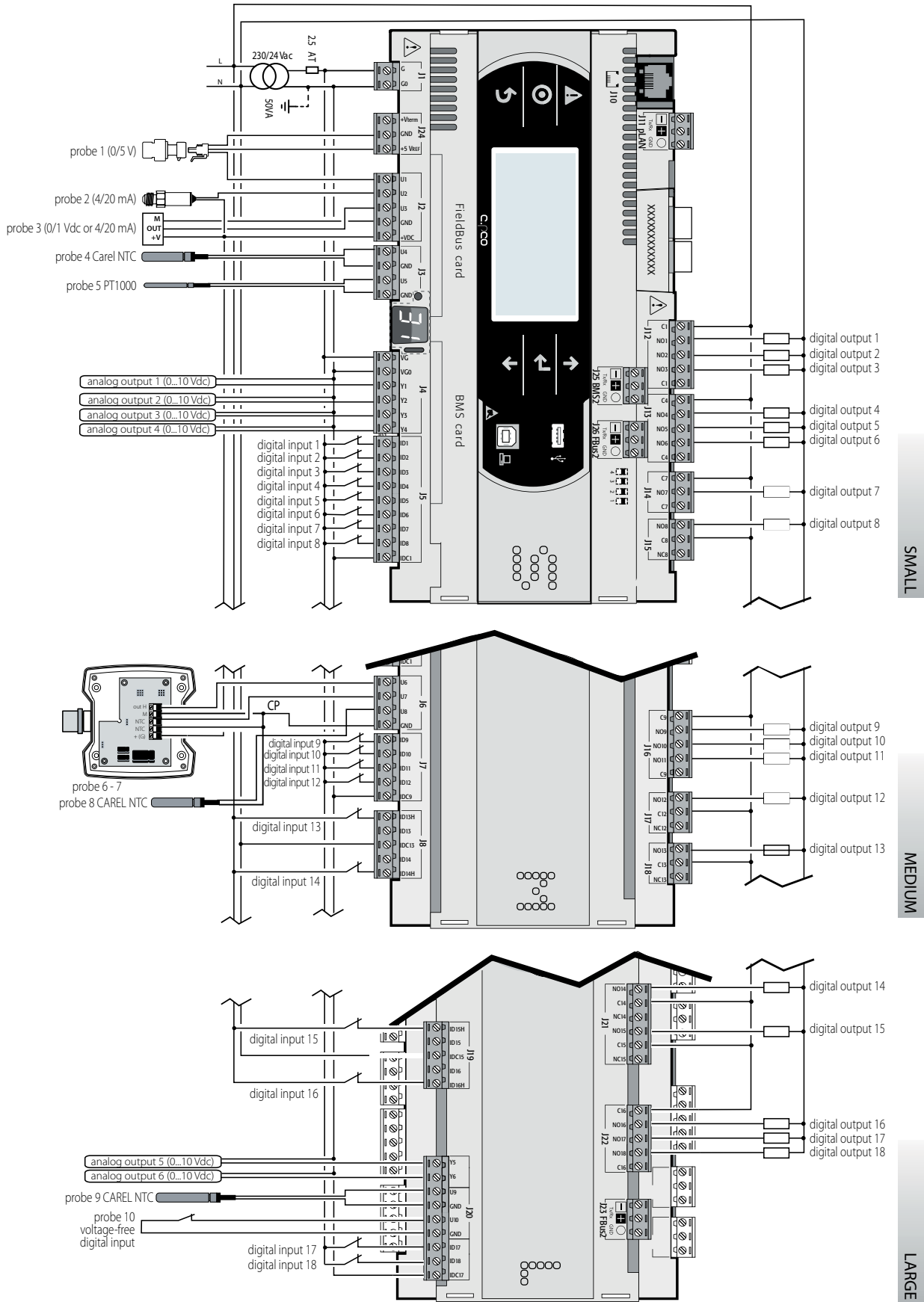

Fig. 5.af

6. START-UP

6.1 Switching on

When the controller is switched on, it runs a test on the secondary display, lighting up the segments one by one.

6.2 Private and shared terminal

All c.pCO controllers can be connected to each other in a local area network (pLAN, see Figure 6.a) in order to share one or more terminals. Shared terminals can show the variables (temperature, humidity, pressure, I/O, alarms) from just one controller at a time. The terminal does not need to be connected to the controller during normal operation, but can be used just for the initial programming of the main parameters. If one or more terminals are disconnected or malfunctioning, the application program continues to work correctly on each controller. Generally, the application program can monitor the status of the network and intervene as necessary to ensure continuity of the control functions. The figure below shows a possible pLAN network connection diagram.

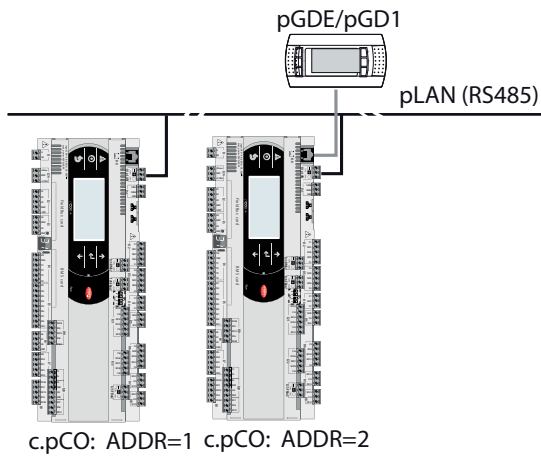

Fig. 6.a

All the terminals and controllers in the network must communicate at the same speed. The speed is adapted automatically.

A maximum of 32 units can be connected, including:

- c.pCO controllers, which run the control program;
- terminals.

Every device belonging to a pLAN network is identified by a unique address, i.e. a number from 1 to 32. The number 32 can be assigned only to a terminal. Programs for different applications (e.g. chillers, air-conditioners, compressor racks, etc.) cannot be automatically integrated into a local network – they must be configured according to the system architecture using the CAREL development tool.

Each controller connected to the network can simultaneously manage up to 3 terminals in the pLAN network (semi-graphic terminals such as pGDs or touch screens such as pGDT / pGDx). The values are displayed on the terminals at the same time and not independently, as if the keypads and the displays were connected in parallel. Because of that, the controller cannot manage different kinds of terminals at the same time.

Each terminal associated with a certain controller is defined as:

- private ("Pr") if it displays only the output of that controller;
- shared ("Sh") if either automatically or from the keypad it can be switched between various controllers.

Each c.pCO constantly updates the displays on the private terminals, while the shared terminals (if present) are updated only by the c.pCO that is controlling the terminal at that time.

The figure below illustrates the logic of the relationships:

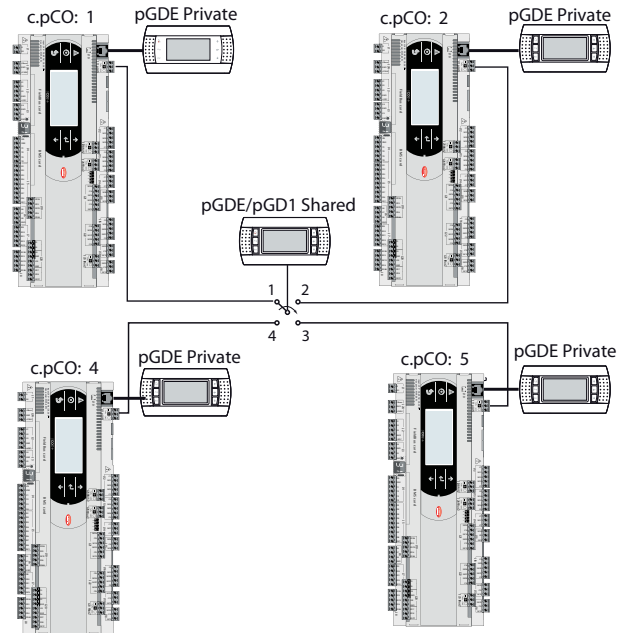

Fig. 6.b

In this example, the shared terminal is associated with 4 controllers, but at this instant only controller 1 can display data and receive commands from the keypad. Switching between controllers occurs:

1. using a command in the system menu;
2. in sequence (1->2->3->4->1...) by pressing a button defined by the application program; however it can also be done automatically when requested by the program. For example, a c.pCO may request control of the shared terminal to display alarms or, vice-versa, relinquish control to the next c.pCO after a set time (cyclical rotation).

Data on the number and type of terminals is determined during initial network configuration and saved in the permanent memory of each c.pCO controller. Details of the configuration procedure are described below. See the "Installation" chapter for information on the cables to use for the electrical connections.

6.3 Setting the controller pLAN address

The controller pLAN address is factory-set as 1.

There are two ways to set a controller address:

1. using button A (see the figure below) located next to the 7-segment display. This can be accessed using the tip of a screwdriver ($\varnothing < 3$ mm);
2. from the system menu (see Chapter 7).

Displaying the pLAN address

The pLAN address is displayed permanently on the pLAN address display.

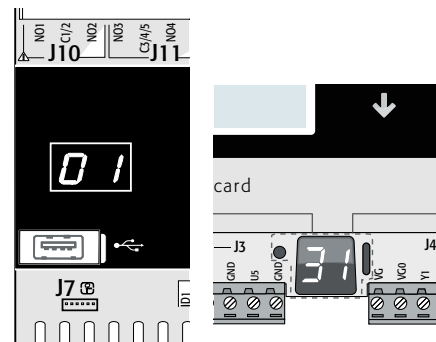

Fig. 6.c

Setting the pLAN address

Procedure 1 - by button

- press button A for 5 seconds: the pLAN address is displayed brighter;
- press repeatedly: the address is incremented
- release the button: after a few seconds, brightness is decreased and the pLAN address is saved in the memory

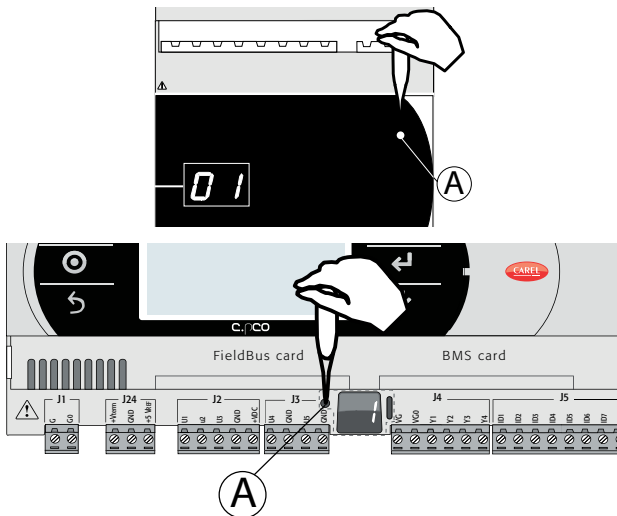
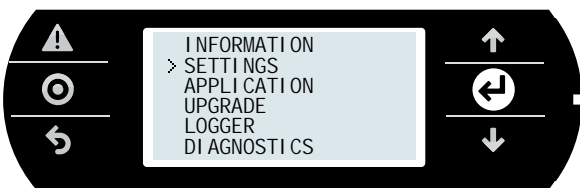

Fig. 6.d

Procedure 2 - system menu

1. press Alarm and Enter together for 3s and enter the system menu. Select settings;



2. select pLAN settings;

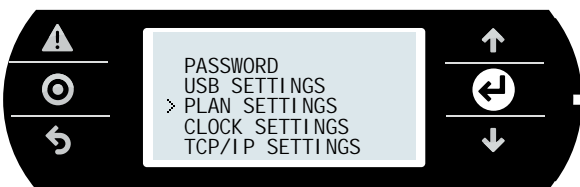

3. modify the controller pLAN address and confirm by selecting "Update configuration".

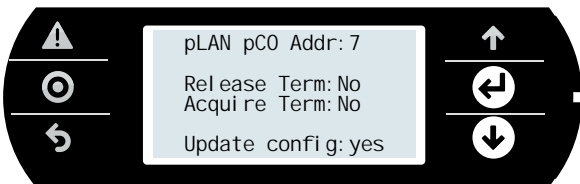

6.4 Setting the terminal address and connecting the controller to the terminal

After setting the controller network address (see previous paragraph), to establish connections between the controller and the terminal, the terminal address needs to be set. If the controller is connected to an external terminal with address 32 (default setting), communication is established (if the built-in terminal is present, the external terminal replicates the same visualization). To configure multiple terminals, private and/or shared, different addresses need to be assigned to the terminals,

and the controller must be properly configured:

1. To configure the address of the terminal, press the UP, DOWN and Enter buttons together for 3 seconds. The screen is displayed in Fig 6.e. Modify the address of the terminal (in the range 1 to 32) and confirm by pressing Enter.

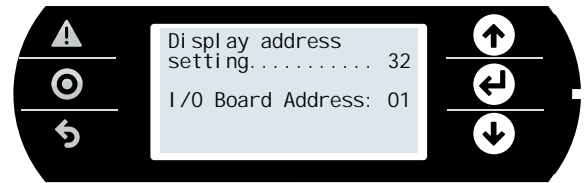

2. A screen is displayed showing the list of the terminals configured. Set the terminals as private (Priv) or shared (Shared) according to the application, and confirm to exit. After a few seconds, the connection will be established.

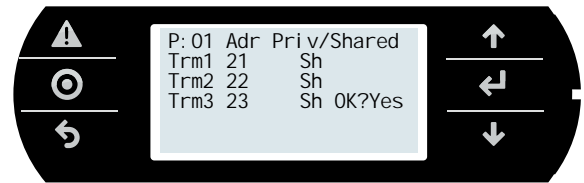

3. To add a second terminal, repeat the previous steps.

6.5 Sharing terminals in a pLAN network

Once connected in a network (pLAN), the c.pCO controllers can share the same pGD terminal. A shared terminal may be needed, for example, to install an update to the operating system and/or application program. Connect the controllers and terminals to the network (Figure 6.g). Set the pLAN address for each controller using the dedicated button (see paragraph 6.3), and for each terminal using the corresponding procedure). The figure below represents three c.pCO controllers in a pLAN network with three pGD displays, each with their own address.

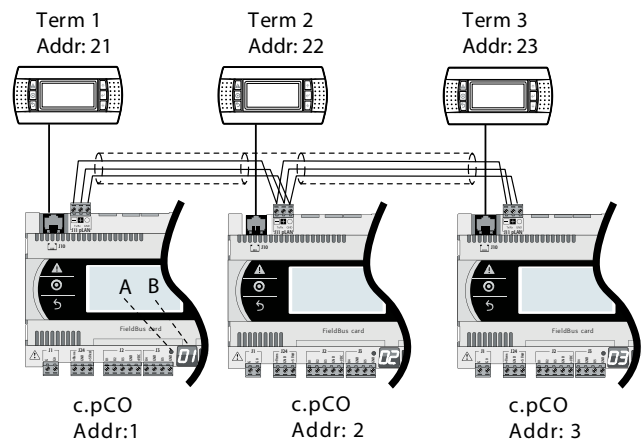
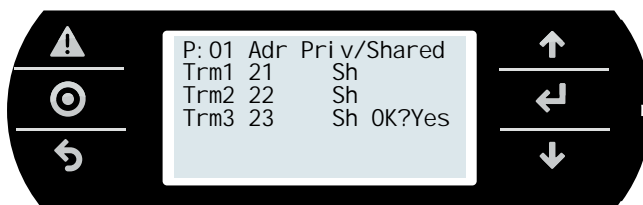

Fig. 6.e

1. To set the address on each terminal (Term1, Term2, Term3), see par. 6.4.
2. Enter the address of the three terminals and set them as "shared". This operation should be repeated for each of the three terminals (see paragraph 6.4).



Acquire/ release commands

These commands are used by a controller to acquire / release a terminal.

Procedure:

1. Press Alarm and ENTER together to enter the system menu. Select "Settings"

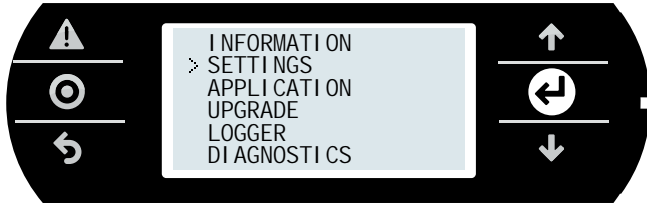

2. Select pLAN Settings

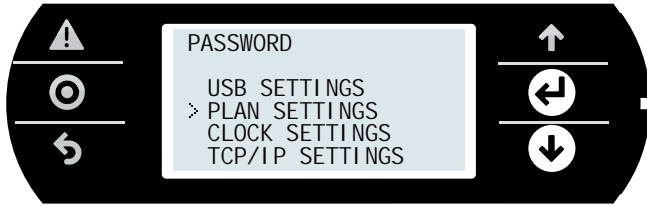

3. The following screen is shown, where the acquire/release commands can be activated.

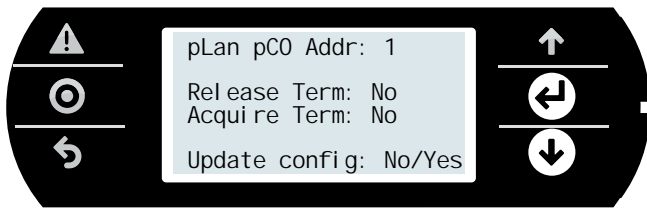

Key	
pLAN pCO addr.	Address of c.pCO controller currently connected to the terminal
Release terminal	Release command
Acquire terminal	Acquire command
Update configuration	Confirm update

Command virtualisation

Whenever a pGD terminal is connected to a c.pCO, the pGD terminal displays the corresponding user interface. The command is sent from the terminal, however it is the controller that executes the operation to release or acquire the terminal.

Example 1

- A: the release command on terminal 21 releases c.pCO 3 from terminal 21, and this is then assigned to c.pCO 1;
- B: the release command on terminal 21 releases c.pCO 1 from terminal 21, and this is then assigned to c.pCO 2.

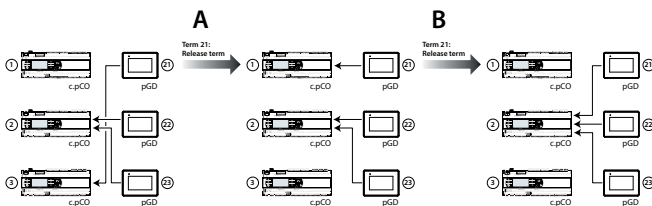

Example 2

- A: the release command on terminal 22 releases c.pCO 3 from terminal 21, and this is then assigned to c.pCO 1;
- B: the release command on terminal 22 releases c.pCO 3 from terminal 22, and this is then assigned to c.pCO 1.

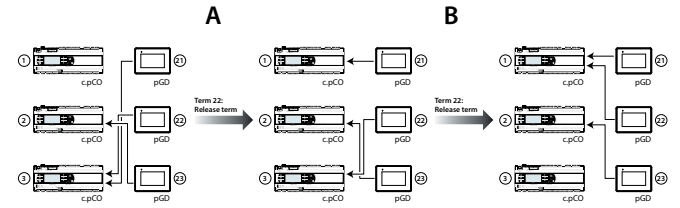

Example 3

- A: the acquire command on terminal 22 acquires c.pCO 1 on terminal 21, and this is thus assigned to c.pCO 1;
- B: the acquire command on terminal 22 has no effect, as c.pCO 1 has already acquired all the terminals

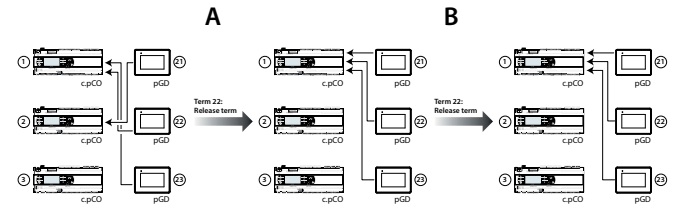

6.6 Uploading/updating the software

It is possible to load/update the application software of the c.pCO controllers family with the following methods:

- Update from computer by using c.factory (via USB or Ethernet connection)
- Update via USB flash drive
- Update with file transfer via FTP (see par. FTP commands)
- Update via tERA cloud service

The c.factory software is part of the "c.suite", but it can be also installed individually, downloading it from <http://ksa.carel.com> under "Software & Support" -> "c.suite".

Update from computer using c.factory

On all c.pCO family controllers, the application program can be uploaded by using the c.factory software, with direct connection to the controller via USB cable or Ethernet network. To upload the application program, proceed as follows:

a) Update from computer using c.factory via Ethernet connection:

Configure the computer and the c.pCO controller so that they belong to the same LAN (see paragraph 9.2).

1. Open c.factory and select the application program file compiled in c.strategy tool (".otr" file extension). The tool will list the configurations defined in c.design. Select the configuration to be loaded on the controller and click "next".

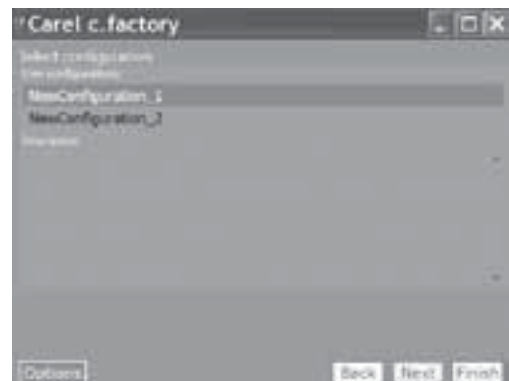

Fig. 6.f

2. Select the files to be loaded on the controller and "Ethernet Connection" type. By pressing "Discover" it is possible to list the c.pCO controllers available in the LAN. Select the MAC address of the c.pCO controller to be updated, and click "upload":



Fig. 6.g

Note: if the c.pCO controller contains an application program that is protected by a different password or digital signature than the new application program, a dialogue box will be shown prompting for the password. If the password entered is correct, the new application program can be uploaded.

3. At the end of the update procedure, the c.pCO controller restarts automatically with the new application program (or new configuration).

b) Update via USB connection:

Connect the computer to the c.pCO controller via USB cable using the device USB port.

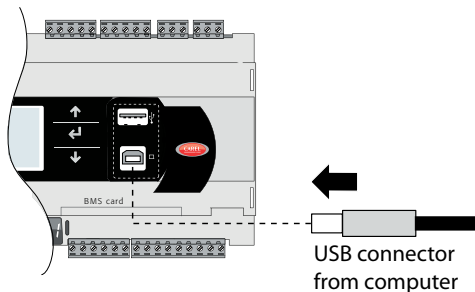

Fig. 6.h

1. Open c.factory and select the application program file compiled in c.suite (.otr file extension). The tool will list the configurations defined in c.design. Select the configuration to be loaded on the controller and click "next".

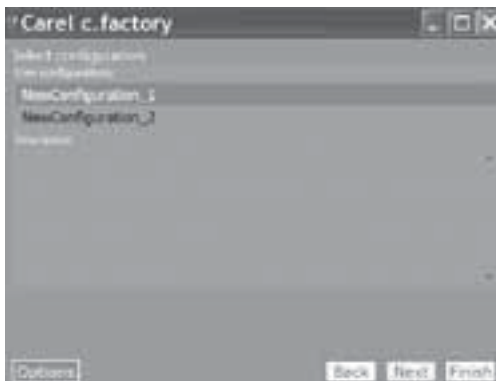

Fig. 6.i

2. Select the files to be loaded on the controller and "USB Connection" type. Select the serial port that the c.pCO controller is connected to via USB cable and click "upload":



Fig. 6.j

Note: if the c.pCO controller contains an application program that is protected by a different password or digital signature than the new application program, a dialogue box will be shown prompting for the previous password. If the password entered is correct, the new application program can be uploaded.

3. At the end of the update procedure, the c.pCO controller restarts automatically with the new application program (or new configuration).

Important: before updating the c.pCO controller via USB connection, check in the system menu that the Device USB port is enabled (Settings --> USB Settings --> PC connection, see Chapter 7).

Update via USB flash drive

All models in the c.pCO family come with a host USB port that can be connected to a USB mass storage device (typically a USB flash drive or portable hard drive), from which an application program can be loaded onto the c.pCO programmable controller.

To update the controller, the application file with extension .ap1 needs to be created in c.factory and loaded onto the USB flash drive:

1. Open c.factory and select the application program file compiled in c.suite (.otr file extension). The tool will list the configurations defined in c.design. Select the configuration to be loaded on the controller and click "next".

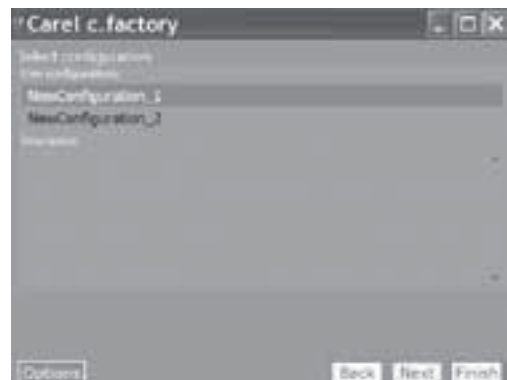

Fig. 6.k

2. Select the files to be loaded onto the controller and click "Export Ap1". In the application package it is possible to include also:
 - the Operating System, selecting the specific path;
 - the web pages for the c.pCO web server functionality (see Chapter 10).

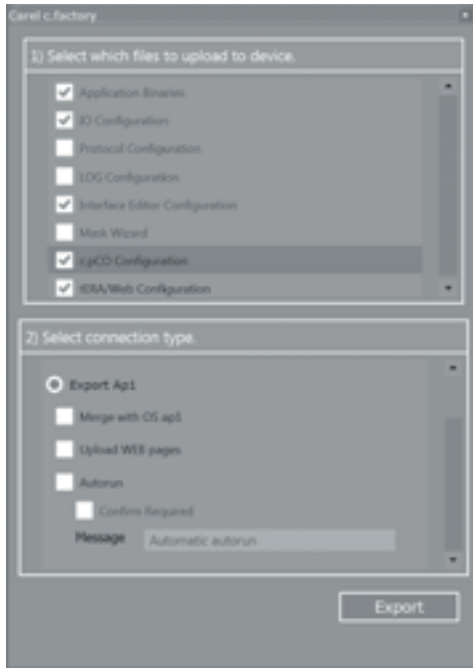

Fig. 6.l

3. Click "Export" and save the file to a flash drive, under a directory called "UPGRADE".
4. Plug the flash drive into the Host USB port and enter the system menu (see Chapter 7). On the screen, select UPGRADE and then the application program to be loaded and confirm by pressing enter.

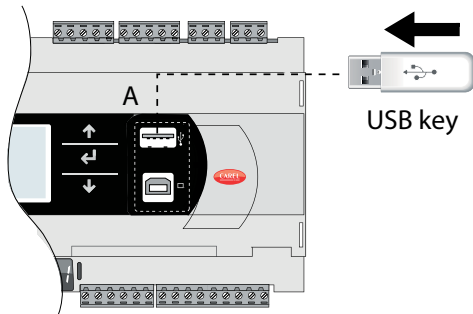
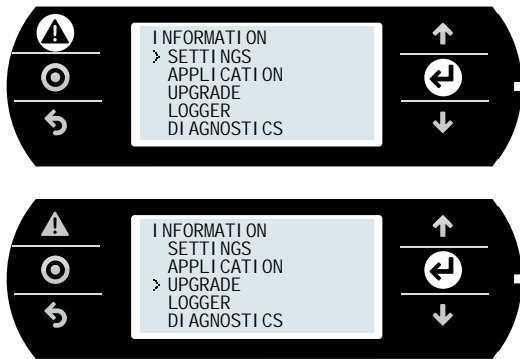

Fig. 6.m



- Do not use both USB ports on the controller at the same time.
- Do not use mass storage peripherals that have a current draw more than 500 mA.

Update with file transfer via FTP

The c.pCO family controllers fitted with Ethernet port include an FTP server that provides access to the public partition of the file system. Files and directories in this partition can be read, modified, created and deleted. FTP can also be used to transfer an .ap1 file, for example to update the image of the operating system or the application program. This is done using an FTP client, for example "FileZilla".

To protect the contents of the public file system against unauthorised access, different users can be created, assigning each a different access profile, dedicated to each service and adapted to the individual directory (see Chapter 9). To update via FTP:

1. Open an FTP client (e.g. FileZilla). Enter the IP address of the c.pCO controller and the access credentials (default user "anonymous", no password).
2. Drag & drop the software update file from the directory on the computer to the "UPGRADE" directory on the c.pCO controller.

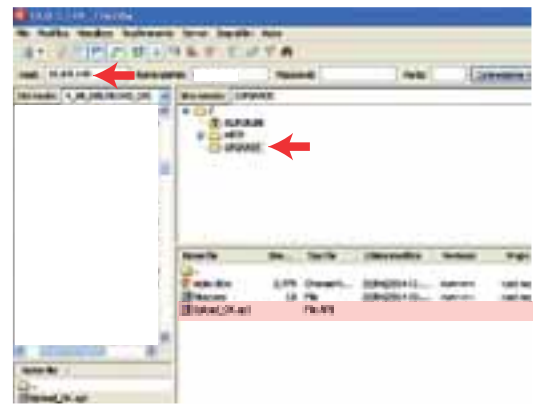
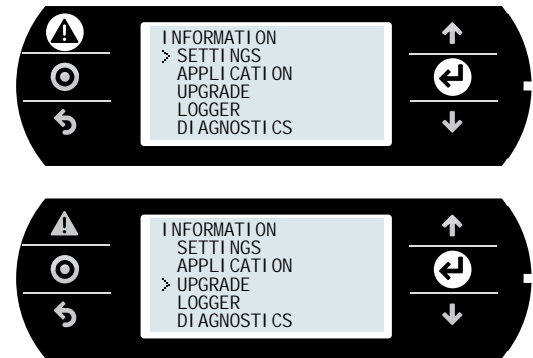

Fig. 6.n

- **Note:** Please use following settings in Filezilla:
 - Edit->Settings->Connection-> set timeout in seconds = 0
 - Edit -> Settings -> Transfers -> set maximum simultaneous transfers to 1
- 3. Access the system menu on the c.pCO and select "UPGRADE" (see Chapter 7).



- **Note:** when having loaded the update file to the "UPGRADE" directory via FTP, the update procedure can also be started using the virtual terminal (see paragraph 10.3).

Update via tERA cloud service.

See paragraph 10.6.

Important:

- Before updating the c.pCO controller via USB connection, check in the system menu that the Host USB port is enabled (Settings --> USB Settings --> Pen drive, see Chapter 7).
- Only use flash drives with FAT file system.

6.7 c.pCOe expansion board: installation and configuration

c.pCOe is an I/O expansion module compatible with the c.pCO and pCO sistema platforms. The module features:

- 10 universal inputs/outputs that can be configured in the application program to connect active and passive probes, digital inputs, analogue and PWM outputs.
- 6 relay digital outputs, divided into 3 groups (see paragraph 5.7)
- Power supply terminals for ratiometric probes and active probes
- Built-in BMS serial interface
- Dipswitches for configuring the communication protocol and serial address

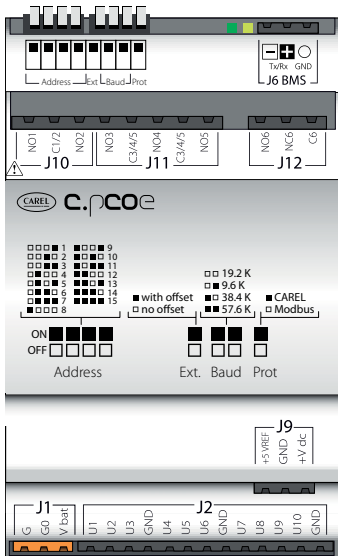

Fig. 6.o

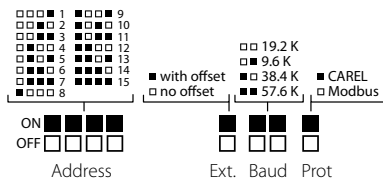

Fig. 6.p

Note: the green LED indicates communication status on the BMS port. If there is communication on the BMS port (online) the green LED flashes, if there is no communication (offline) the LED stays on steady.

Important: Power supply to the product must only be connected between G and G0. The Vbat terminal is only used for connection to the Ultracap module as emergency power supply in the event of a power failure.

The dipswitches can be used to set the expansion board serial address (from 1 to 15), protocol (Modbus or Carel) and baud rate. By serial connection it is possible to modify the electrical configuration of the line and assign a serial address from 16 to 247 (207 if using the Carel protocol).

Baud rate and communication protocol settings

Board default configuration is baud rate 19.2 Kbps and Modbus protocol. The "Baud" and "Prot" dipswitches (see Fig. 6.u) can be used to set the baud rate and the communication protocol used by the expansion board. The unit must be switched off before making the settings on the dipswitches.

Important: if the baud rate and protocol settings are changed on the dipswitches while the unit is on, this must be restarted to activate the new settings.

Address and serial communication mode settings

To assign to the board a serial address from 1 to 15, simply set the dipswitches as shown in Figure 6.u. The "Ext" dipswitch must be set to "OFF" (no offset). The unit must be switched off before making the settings on the dipswitches.

Important: if the settings are changed on the dipswitches while the unit is on, this must be restarted to activate the new settings.

To assign to the the board a serial address from 16 to 247 and to configure the serial communication settings, an offset needs to be sent to the expansion board via serial communication, which is then added to the "Address" dipswitch configuration, and the variable corresponding to the serial transmission parameters needs to be set, as follows:

Example (address setting N=87, serial communication 8, Even, 1):

1. Set the dipswitches of the "Address" group and the dipswitch "Ext." a OFF.
2. Restart the unit. The c.pCOE will go into "Set Mode". **Warning: activating this mode resets both the address offset and the serial communication settings.** In this mode, the board serial address will be 207 and the serial configuration will be 8 bits, no parity and 2 stop bits (8 bits, None, 2). The yellow LED flashes.
3. To set the communication parameters, the "Serial Transmission Configuration" variable needs to be set via serial communication (see Table 6.a and 6.b). In this example, the variable is set to 5 (configuration 8, Even, 1).
4. To set the serial address, the "Address Extension" offset variable needs to be set via serial communication (the offset must be greater than 14, see Table 6.a). In this example, it can be set to 86.
5. Move the "Ext" dipswitch to ON. Set the "Address" dipswitches to a value greater than 0. In this example, the value is set to 1.
6. Restart the unit. After restarting, the expansion card will be configured with the serial address calculated as the sum of the value set for the "Address Extension" variable and the value set on the "Address" dipswitches (in this example $86 + 1 = 87$). After restarting, the expansion card will have the serial communication configuration 8, Even, 1.

Variable	Carel Address (Integer)	Min Value Carel	Max Value Carel	Modbus Address (Holding Register)	Min Value Modbus	Max Value Modbus
Address Extension	14	15	192	14	15	232
Serial Configuration	17	0	5	17	0	5

Tab. 6.a

Important:

- If using the Carel protocol, the maximum settable offset is 192.
- The following configurations are not allowed:
 - The "Ext" dipswitch cannot be ON with an offset equal to 0 ("Address Extension" variable = 0). In this case, the card will signal a configuration error, with the yellow LED on steady. The green LED remains on, indicating that the card is offline.
 - The "Ext" dipswitch cannot be ON with an offset other than 0 and the "Address" dipswitches set to 0 (all OFF). In this case, the card will signal a configuration error, with the yellow LED flashing. The green LED remains on, indicating that the card is offline.

Serial Configuration	
Value	Configuration
0	8, none, 2
1	8, none, 1
2	8, odd, 2
3	8, odd, 1
4	8, even, 2
5	8, even, 1

Tab. 6.b

7. SYSTEM MENU

7.1 Menu tree

Press Alarm and Enter together for 3 seconds to enter the menu tree:

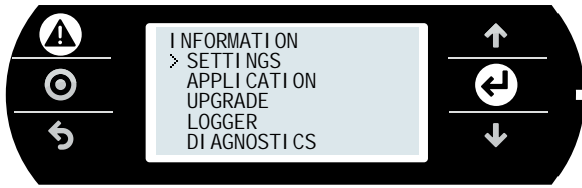

Fig. 7.a

INFORMATION	PCO INFORMATION	SETTINGS	PASSWORD	APPLICATION	STOP APPLICATION	UPGRADE	LOGGER	EXPORT LOGS	DIAGNOSTICS	SYSTEM LOGS
	I/O INFO		USB SETTINGS		START APPLICATION			RESTART LOGS		
	MEMORY INFO		TERMINAL SETTINGS		RESTART APPLICATION			FLUSH LOGS		
	PLAN INFO		CLOCK SETTINGS		WIPE RETAIN			WIPE LOGS		
	FYLESYSTEM INFO		TCP/ IP SETTINGS		WIPE NVRAM					
	TASK INFO				UI MANAGEMENT					
	APPLICATION INFO				BUILT IN SETTINGS					
	BUILT IN INFO									

Fig. 7.b

Below is the description of the screens that will be displayed during navigation:

INFORMATION

PCO INFORMATION:

Screen description	Description
BT v. x. xxx xxxx/xx/xx	Bootloader version
OS v. x. xxx xxxx/xx/xx	Operating System version
SVN REV xxxx	
MAC xx-xx-xx-xx-xx-xx	Ethernet card MAC address, also shown on the label above the Ethernet port
UID xxxxxxxxxxxxxxxxxxxx	Hardware unique ID
tERA xxxxxxxx	Code for activating the tERA service

I/O INFO:

Screen description	Description
1 FW xx. xx HW xx. xx	HW and SW version of the I/O chip
2 FW xx. xx HW xx. xx	
3 FW xx. xx HW xx. xx	
4 FW xx. xx HW xx. xx	

MEMORY INFO:

Screen description	Description
	RAM memory:
used RAM: xxxxxK	total used (sum of the following values)
OS xxxxxK	used by the operating system for internal functions
Application xxxxxK	used by the application
Virtual Machine xxxxxK	used by the virtual machine that runs the app
Internal memory xxxxxK	reserved for the app's internal functions
free RAM: xxxxxK	not yet used

PLAN INFO:

Screen description	Description
pLAN Address	Display pLAN address and terminals assigned
ENTER to graph net	Graphic view of the pLAN network

FYLESYSTEM INFO:

Volume 0 comprises 32 Mbytes, and cannot be accessed directly, consequently the application program can only be copied to this location from c.suite. Volume 1 comprises 96 Mbytes of NAND flash memory available to the user. By USB device port, or FTP protocol it is possible to access this public file system in order to save applications, documents, web pages, system logs.

MSD: flash drive recognition on host port.

volume	size	free
nand: 0	30	xx MB
nand: 1	91	xx MB
msd: 0	0	0 MB

TASK INFO: Reserved

APPLICATION INFO:

Screen description	Description
APPLICATION STATISTICS	RAM:
	RAM memory occupied
conf xxxxK, prot xxxxK	<ul style="list-style-type: none"> by the variable map used outside the strategy by the variable map for the protocols
data xxxxK, code xxxxK	<ul style="list-style-type: none"> by the map variables inside the strategy by the code contained in the application POUs
UI xxxxK	by the User Interface configuration
cycle time:	
last cycle xxxxms	duration of the last application cycle
maximum cycle xxxxms	duration of the longest application cycle

BUILT-IN INFO:

Screen description	Description
Built-in type: xx	Information on the built-in display, if featured
FW release: x. xx	

SETTINGS

PASSWORD:

Screen description	Description
insert new password 00000	Password to prevent access to all the pages of the tree menu, except for PCO INFORMATION. To cancel the password, set it to 00000.
Update password?	

USB SETTINGS

Screen description	Description
USB HOST	
Pen drive: Enable/disable	Enable/disable the Host/ Device USB ports. Only use one port at a time, host or device
USB DEVICE	
PC connection: Enable/disable	Enable/disable the c.pCO controller as a serial port for c.suite
pCO disk: Enable/disable	Enable/disable the c.pCO controller as a storage device
Status (host/device): not connected/wait / ready	Connection status: Not connected: peripheral not connected Wait: connecting Ready: peripheral ready to be used

PLAN SETTINGS:

Screen description	Description
pLAN pCO Addr: x	Address of the c.pCO controller that the terminal is currently connected to
Release term: No	Release command
Acquire term: No	Acquire command
Update config: No	Confirm update

CLOCK SETTINGS:

Screen description	Description
DATE/TIME	
Date: xxxx/xx/xx	Date setting
Time: xx:xx:xx	Time setting
DST is off/on	Information on Daylight Saving Time
Update date/time ?	Confirm update
TIME SYNC	
Clock sync: xxx	Synchronisation setting: manual, via tERA or via NTP.
Update Config?	Confirm update
TIME ZONE	Display the time zone

TCP/IP SETTINGS:

Screen description	Description
DHCP: Off/On	Static/dynamic address
IP: xxx.xxx.x.x	IP address
MASK: xxx.xxx.xxx.x	Net mask
Gateway: x.x.x.x	Gateway
DNS: x.x.x.x	DNS
Name	Host name, only changeable from c.suite
Update config? No/Si	Update settings

APPLICATION

Screen description	Description
STOP APPLI CATION	To stop/re-start execution of the application program
START APPLI CATION	
RESTART APPLI CATION	Corresponds to STOP + START
WI PE RETAIN	The "Retain" variables return to the default values
WI PE NVRAM	Clear clock or RAM buffer memory: this stores the values of parameters that change often, such as counters (if configured in the application).

Screen description	Description
UI MANAGEMENT	
Active UI: i/N	Activate the set of screens, 'i' of 'N'
Active trans: i/N	Active translation 'i' of 'N'
Prg to load next UI	Press Prg to load the next set of screens
Ent to load next trans	Press Enter to load the next application language

Screen description	Description
BUILT IN SETTINGS	
Bklight idle val: xxx	Backlighting intensity set after backlight idle time.
Bklight idle time: xxx	Time (s) before setting Bklight idle val. Function disable if equal to 0.
Buzzer is off/on	Buzzer status
Auto off time is off	Built-In terminal auto backlighting off
Confirm value? No/yes	Confirm update

UPGRADE

Screen description	Description
> xxx.ap1	With the USB flash drive plugged into the host USB port: .ap1 file contained in the Upgrade directory on the drive. With the USB flash drive not plugged in: .ap1 file in the NAND1 partition (90 Mbytes).

LOGGER

Screen description	Description
EXPORT LOGS	Export the logger files
RESTART LOGS	For periodical logs activated/terminated by variable, start logging again.
FLUSH LOGS	Save the logs to memory. Logs: max 32, max 4 Mbytes in binary format
WI PE LOGS	Delete all the data and restart logging from the beginning

DIAGNOSTICS

Screen description	Description
SYSTEM LOGS	Export the system log for diagnostics as a .zip file

8. PROTECTION: PASSWORD AND DIGITAL SIGNATURE MANAGEMENT

The c.pCO controller implements protection methods aimed at preventing unauthorised personnel from performing certain sensitive operations like updating the software, accessing the system menu, cloning proprietary software, etc.

It is possible to protect the c.pCO controller by setting a password or a digital signature. Signing the controller by digital signature is an irreversible process, while the password can be modified or cancelled. The password is applied by default in the c.suite development tool, while the digital signature is an additional function enabled with a dedicated license.

8.1 Protection features

	Protection password	Digital signature
Purpose	To prevent the software being loaded/updated by unauthorised personnel. To prevent the software from being cloned.	
c.pCO signing	Reversible	Irreversible
Generation	By c.suite	
Activation	Function included in standard c.suite	Function to be activated with optional additional license
Number of passwords/signatures	c.suite software can be used to generate multiple signatures and/or passwords	
Implementation	The application is protected with a password before being uploaded into the c.pCO (see paragraph 6.6 for uploading procedures)	c.pCO is signed by uploading a digital signature via USB flash drive. The application to be uploaded must be protected with the same signature.

Tab. 8.a

8.2 Protection Password

The protection password can be set inside the c.design tool, under "c.pCO Configuration Editor". A protection password can be set for each configuration. The protection password has no effect if using a digital signature.

To set the protection password, proceed as follows:

1. Open c.design and select or create a new configuration. Click "c.pCO Config Editor":



Fig. 8.a

2. Select the "Protection" tab:

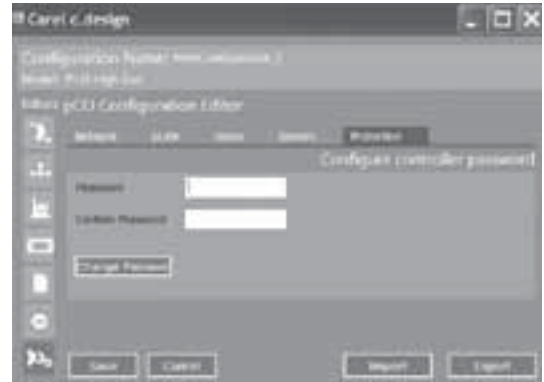

Fig. 8.b

3. Enter the desired password to protect the controller-application (upto 8 alphanumeric characters).



Note:

- To modify the protection password for a configuration, fill the "Previous Password" field and enter a new password in the "Password" field.
 - To cancel the protection password for a configuration, fill the "Previous Password" field and leave the "Password" field empty.
4. Click "Save". The Upload page will be displayed. Open c.factory by clicking "Upload to Device".



Fig. 8.c

5. From the options flag "c.pCO Configuration Editor" and select proper type of connection.



Note: all the sections of "c.pCO Configuration Editor" need to be correctly filled (Network, pLAN, Users, Servers, Protection).



Fig. 8.d

- Upload the signed application. If performing the operation on a controller that already contains a protected application, the previous protection password needs to be entered (see the figure below).

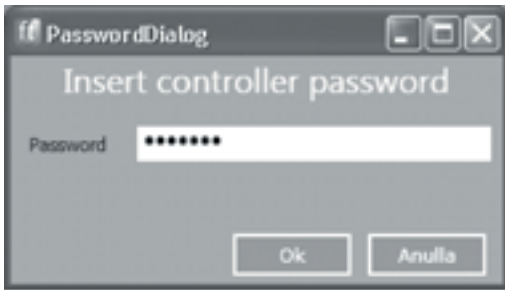

Fig. 8.e

Note: if loading an application program signed with the same password, the password does not need to be entered again.

- A status screen shows the progress of the upload; at the end, click OK and "Close" to close "C.factory"



Fig. 8.f

Note: to complete activation of the protection password, power the controller off and on again.

8.3 Digital signature generation

Protection system by digital signature, if enabled by optional license, prevents the programmable controller from being overwritten with unauthorised software.

The controller is indelibly signed, with the password defined in c.design tool. After a controller has been signed with a specific digital signature, it can only be used with applications signed with the same digital signature (see paragraph 8.4), and the digital signature applied cannot be erased or modified.

To sign a c.pCO with a digital signature, proceed as follows:

- Open c.design and select or create a new configuration. Click "c.pCO Config Editor":

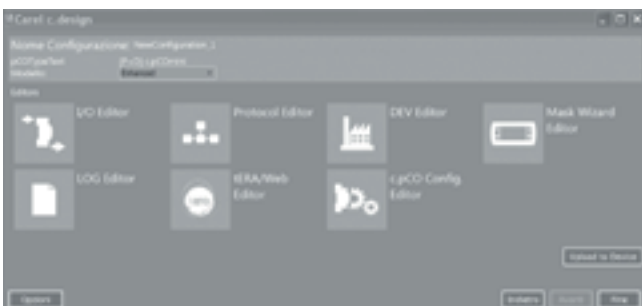

Fig. 8.g

- Select the "Protection" tab:

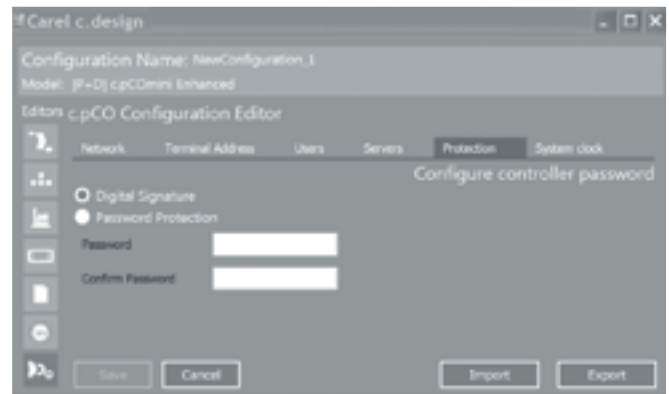

Fig. 8.h

- Flag "Digital Signature", and insert password corresponding to the new digital signature to be generated (8 alphanumeric characters). Then click save.

Notes:

- Digital signature option is shown only if "Digital Signature" license has been activated.
- To modify the password of a digital signature, fill the "Previous Password" field and enter a new password in the "Password" field.
- To remove the digital signature from a configuration, fill the "Previous Password" field and leave the "Password" field empty.

- Click "Save". The Upload page will be displayed. Open c.factory by clicking "Upload to Device".



Fig. 8.i

- Click "GenerateSignature": a screen is shown for selecting the path where to save the digital signature file. Name and save the .ap1 file in a directory called "UPGRADE" on a USB flash drive.

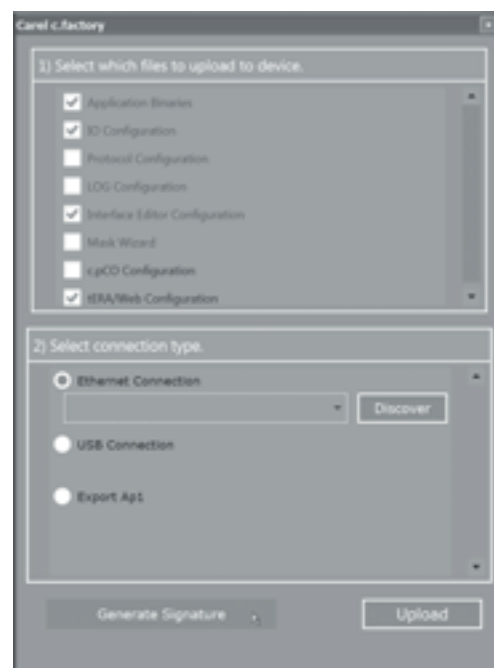

Fig. 8.j

6. To load the digital signature to the controller:
 - plug the USB flash drive into the host USB port.
 - press Alarm and Enter together to enter the system menu;
 - select "Upgrade" and confirm by pressing Enter; the controller is indelibly signed with the digital signature, it can only be used with applications signed with the same digital signature (see par. 8.4).

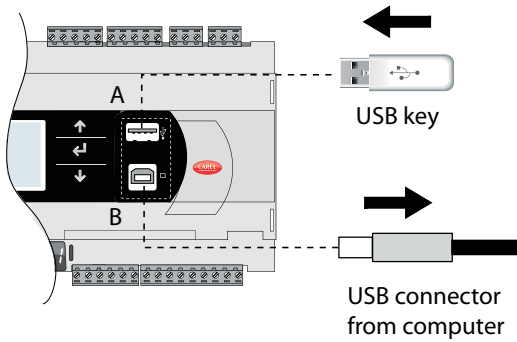
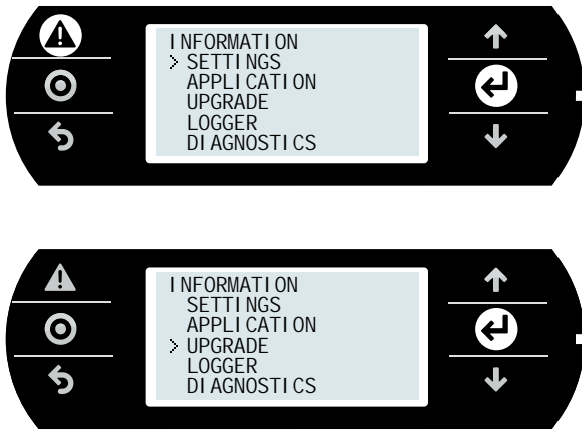

Fig. 8.k



8.5 System menu password

System menu password prevents access to the system menu, except for the information screen ("PCO INFORMATION", see paragraph 7.1).

Procedure:

1. Press Alarm and Enter together for 3 seconds to enter the system menu;
2. Select Settings --> Password
3. Press Enter; set a value > 000000 using UP/DOWN.
4. Confirm the changes.

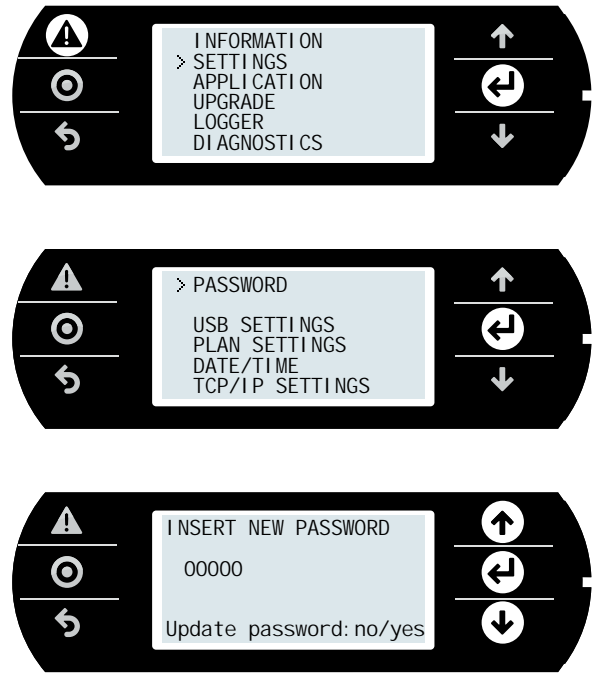

Note: to complete activation of the digital signature, power the controller off and on again.

Warning: digital signature cannot be erased once applied.

8.4 Loading an application program on a controller signed with digital signature

A c.pCO controller signed with a Digital Signature can be used only with an application software signed with the same signature. In order to generate an application signed with Digital Signature, it is necessary to follow the procedure described in the previous paragraph and proceed with the installation of the application as described in paragraph 6.6.

If the digital signature for the application program being loaded on the c.pCO does not correspond to the digital signature on the controller, when loading the application program by using c.factory tool, a screen is displayed prompting for the password corresponding to the digital signature currently loaded on the c.pCO.

If the password entered is correct, the program will be uploaded correctly.

Note: if both a protection password and a digital signature have been set on a c.pCO, the latter has priority.

9. ACCESS MANAGEMENT FOR IP SERVICES

- c.pCO controllers integrate a Web Server and a FTP Server:
- Web server: used to access the files (HTML pages, images, JavaScript code, etc.) stored under the /HTTP/ directory of the public partition in the file system. These pages can show dynamic contents generated by CGI calls (Common Gateway Interface), managed by the controller firmware in order to read/write variables of the application and create logs and custom dynamic pages. These pages are accessed in a LAN by using a browser, entering the c.pCO controller IP address or hostname;
 - FTP server: used to access the public partition in the file system, to read, edit, create and delete files and directories, including web pages. FTP can also be used to transfer a .ap1 file, for example, to update the image of the operating system or the application program. The files are accessed using an FTP client, such as "FileZilla".

For protecting the contents of the public file system against unauthorised access, the system administrator can create different users, and assign each user different access profiles, differentiated for each service and adapted to the individual directory.

- Access configuration is performed in two steps
1. create users in c.design;
 2. create authorisation files in the directories of the public file system that need to be protected.

9.1 Accounts management

c.pCO does not have any account configured by default, consequently the entire public file system has read/write access to the default user ("anonymous") and web access without authentication. This simplifies the operations for first installation of the application program and web pages via FTP/HTTP protocol. Subsequently, accounts can be created so as to restrict access to the public file system. The accounts who can access the IP services are created in c.design. Open c.design and access the configuration editor.



Fig. 9.a

Click "c.pCO Config. Editor": the user configuration page will be shown. Enter the user name and password and confirm by clicking "Add user" for each new user.



Fig. 9.b

Example: the following three users have been created:

User name	Password
dave	davepasswd
bryan	bryanpasswd
ron	ronpasswd

Select the directory where the application program files are located and click "Upload" to load these accounts into the c.pCO controller.

- Note:**
- max number of users: 5;
 - max number of characters in the user name: 15;
 - max number of characters in the password: 15;
 - in addition to the users saved in the database, the FTP server retains the default user, called "anonymous". This special user allows public access to certain directories and to new c.pCO controllers without any users configured. The anonymous user does not require authentication (any password can be entered) and access will be restricted to the directories that have no authorisation files (ftaccess, as illustrated below).

The authorisation files contain a list of users who can access the current directory. Only the users listed in the authorisation file can access the corresponding directory.

- Note:** an authorisation file only prevents access to the files in the directory where this is located, and not the files in any sub-directories. To disable access to the various sub-directories, the authorisation file needs to be copied to each of these.

- The authorisation file is a simple text file, called:
- "htaccess", when it authorises users of web server services;
 - "ftaccess", when it authorises users of FTP server services.

Authorisation file structure

The authorisation file contains a list of user names who are authorised to access the directory in question, one on each line. There is no extension (e.g. ".txt").

Example: the authorisation file for the three users created previously will have the following layout, and be called "ftaccess" or "htaccess".

ftaccess/htaccess
dave
bryan
ron

- Whenever a user needs to access a file (web) or directory (FTP), the following procedure is applied to grant/deny access:
1. verify whether the authorisation file (htaccess or ftaccess) exists in the requested directory. If no file exists, access is granted;
 2. if the file exists, this is opened and read sequentially to check whether the user making the request is included in the list; if not, access is denied;
 3. if the user is included in the authorisation file, the system looks up the user name in the user database. If not found, access is denied;
 4. if the user is known, authentication by password is required; if the password is correct, access is granted.

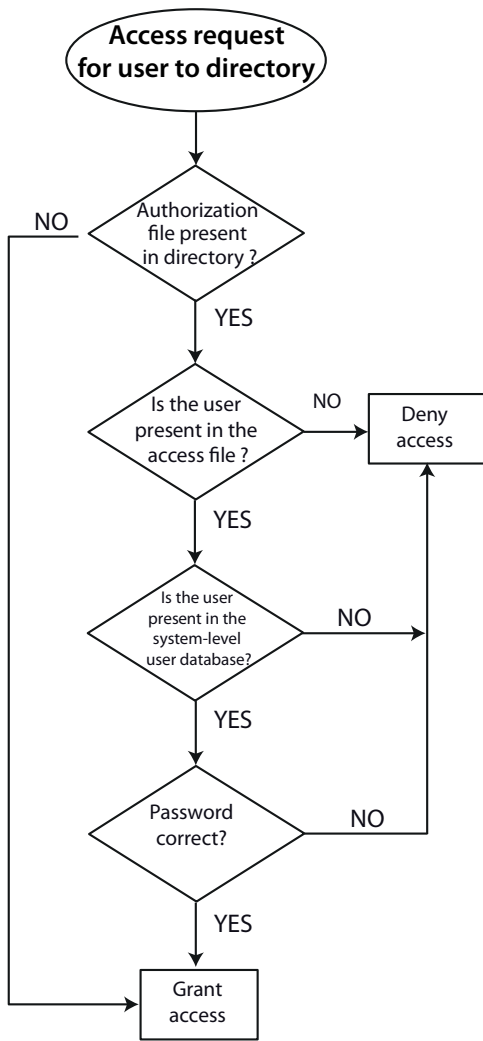

Fig. 9.c

9.2 Computer - c.pCO connection

There are two ways to connect the c.pCO controller to a computer via Ethernet:

1. computer-c.pCO direct connection;
2. network LAN connection with DHCP server

Computer-c.pCO direct connection

Connect one end of the network cable to the Ethernet port on the computer and the other end to a any of the Ethernet ports on the c.pCO; LEDs blinking indicate correct connection. The Ethernet ports on the c.pCO are auto-crossing (Auto MDI-X), therefore no crossover cable is needed. After connection through Ethernet cable, computer and controller IP addresses must be properly configure in order to belong to the same IP subnetwork.

Configuration example:

Computer:

IP address: 192.168.0.2
Subnet mask: 255.255.255.0

c.pCO controller:

1. press Alarm and Enter together for 3 seconds to access the system menu;
2. Select Settings -->TCP/IP settings: DHCP = OFF and enter an address in the same subnet set on the PC, for example:
IP: 192.168.0.1
MASK: 255.255.255.0
3. Select update configuration --> Yes

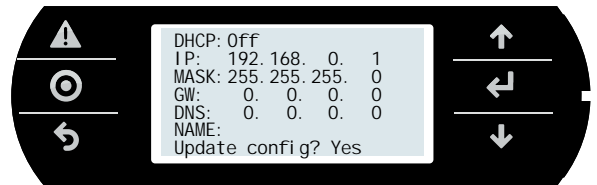
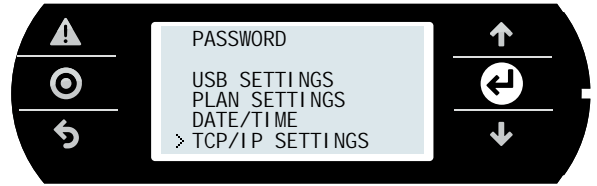
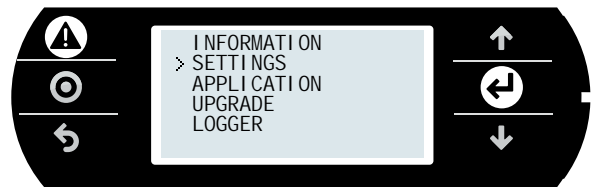

Network LAN connection with DHCP server

Before connecting the c.pCO controller to the LAN, access the system menu and verify that DHCP: On (default setting).

Then connect the c.pCO to the LAN. The IP address is automatically assigned to the c.pCO by the DHCP server, and it can be displayed in the system screens (Settings -->TCP/IP settings).

9.3 FTP connection with authentication

Once having connected the computer to the c.pCO via Ethernet, FTP protocol can be used to transfer files. The program used in this example is "FileZilla", downloadable for free from the Internet.

Proceed as follows:

1. open FileZilla: the following screen will be shown;
2. enter the IP address (or hostname) of the c.pCO controller, the user name --> anonymous and password -->"empty" and select "Quick Connect";
3. the user can access all the directories highlighted, as these do not contain the "ftaccess" file: UPGRADE, HTTP. Access is also available to the HTTP directory and its sub-directories.



Nota: Please use following settings in Filezilla:

- Edit->Settings->Connection-> set timeout in seconds = 0
- Edit -> Settings -> Transfers -> set maximum simultaneous transfers to 1

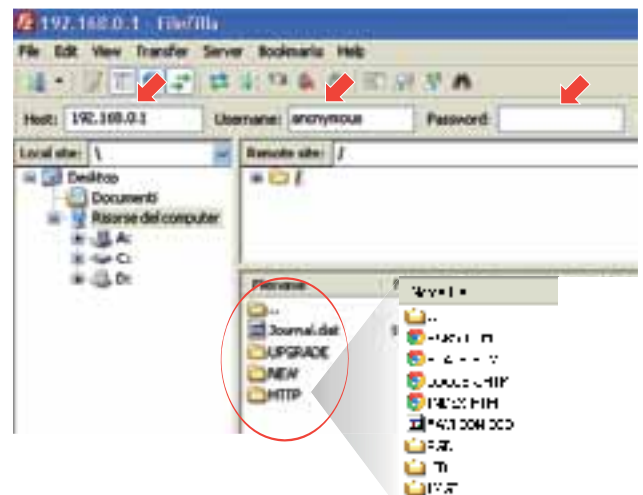

Fig. 9.d

Access to the different directories can be restricted, assigning different user lists (see paragraph 9.1).

Important: in the event of errors when copying the authorisation files and consequently denial of access, the authorisation files can only be deleted by direct connection to the USB device port.

9.4 HTTP connection with authentication

This paragraph shows how to restrict access to the web interface or part of it. In the example, a website is created with several pages in "\HTTP", administration pages in "\HTTP\admin" and user pages in "\HTTP\user". Only "dave" and "ron" can access the administration pages, while the user pages are only accessible to "bryan". All three users can see the common pages in "\HTTP". The authorisation files shown in the table need to be created and copied by FTP to the corresponding directories (see paragraph 9.1):

No.	Authorisation file	In directory	User	Password
1	htaccess	HTTP	dave	davepasswd
			bryan	bryanpasswd
			ron	ronpasswd
2	htaccess	HTTP\admin	dave	davepasswd
			ron	ronpasswd
3	htaccess	HTTP\user	bryan	bryanpasswd

Accessing an address of the c.pCO Web Server by using a web browser, then a pop-up window will be shown prompting for the user name and password.



Fig. 9.e

If the user name/password are recognised and the user has been authorised to access the directory, for example "dave", the web server grants access to the pages, and these can be displayed by the browser.



Fig. 9.f

10. WEB SERVER AND TERA CLOUD PLATFORM

c.pCO controllers family features an integrated web server that can be completely customised by the user. The c.pCO web server can support HTML and JavaScript standards. Custom web pages can be copied in the public file system, in the /HTTP/directory. c.pCO implements some CGI (Common Gateway Interface) scripts that allow to dynamically read and write application variables in order to create dynamic content. A freely customisable package called "Web kit" is available to simplify the creation of custom webpages for the c.pCO. The Web kit comprises sample HTML pages and JavaScript libraries for managing dynamic CGI, fully exploiting the potential of the c.pCO web server. In particular, the examples provided can be used to:

1. display the contents of the pGD1 on the browser pages (pGDWeb, see paragraph 10.3)
2. display the list of public variables in the application program, allowing the values to be read and write;
3. display the network status, with the addresses of the connected devices;
4. plot data on graphs, both in real time as well as extracted from logged data.

10.1 Web kit download and installation

The freely customisable web package called "Web kit" can be downloaded in ksa.carel.com. The package must be saved in the c.pCO public file system:

1. unzip the .zip file;
2. copy the contents to the /HTTP/ directory in the c.pCO file system by using the USB device port or FTP protocol through Ethernet (see picture below).
3. Disconnect Usb cable from USB device port.

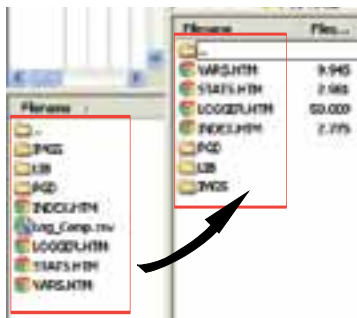

Fig. 10.a

4. After copy of the Web kit package into folder /HTTP/, it is possible to access web pages by using a web browser. It is sufficient to connect the c.pCO and the computer in the same local network and write in the browser address bar the c.pCO IP address (see paragraph 9.2).

The web pages are independent from application software loaded into the controller, and they are developed to be customized according to the specific application.



Fig. 10.b

10.2 Contents of the package

Directory	Sub-directory	Contents
imgs		Images used by all the pages
lib		File libraries: CSS (Cascaded Style Sheet) and JavaScript for dynamic variable handling, graphs from logs and graphs in real time. Default CSS file (optimised for browser with 1024 pixel resolution)
	calendar	Graphic elements (calendar) used by the log pages
	jscolor	Graphic elements (color picker) used by the log pages
pgd		pGD web interface: do not delete or remove files from here. Index.html can be customised, so as to change the pGD eeb screen.
	imgs	Image files used by the pGD web interface: do not delete or remove files from here
favicon.ico		Browser "favourite" icons, can be completely customised

Tab. 10.a

10.3 Web pGD

The virtual terminal shows the information displayed on the pGD terminal connected to the c.pCO in real time.



Fig. 10.c

Key	
1	Active area (394 x 198 pixels)
2	Buttons that can be activated by clicking the mouse
3	Function to press multiple buttons
4	LEDs



Customisation notes:

- The virtual pGD is a matrix of 132 x 64 elements measuring 3 x 3 pixels;
- The background for the LCD matrix measures 394 x 198 pixels;
- The background colour is black (RGB 0, 0, 0), the colour of the display is light blue (RGB 106, 188, 231);
- The image of the pGD1 is 870 x 455, the background starts at (x, y = 238, 128) and ends at (x, y = 632, 326);
- The width of the buttons is 27%, the heights are 20%, 19%, 19%, 23%: these proportions must be maintained to change the background image.

See the comments in: /pgd/index.htm for further details on customising this page.

10.4 Variables table

The variables table includes the public variables exposed by the application software. Names and descriptions are defined in c.suite development environment.



Fig. 10.d

Key	
1	Frame: blue = communication, red = no communication
2	Variable refresh time
3	Checkbox to enable in order to write variables

Writing the variables

Procedure:

- enable the writing checking box;
- enter the value in the corresponding field;
- click Set or "Set all selected variables".

10.5 Variable trend (logger)

The names of the logs are loaded dynamically by the c.pCO based on the Log editor settings in c.design. This means the drop-down menu for choosing the log to be displayed is populated automatically, without having to modify the web page:

- choose the log to be displayed from the drop-down menu at the top;
- set the display interval, as start and end date/time or using the quick links on the right, used to load the last 'N' days/weeks logged;
- click "Load log data" to load the log and display the corresponding graph.

The graph can then be adapted using the mouse (or touch, when using a touch screen) to zoom, change the colour of the lines, display the numeric values of the variables at a certain point on the graph, or enable the secondary axis.

A screenshot in image format can be saved at any time, or the data exported in CSV format.

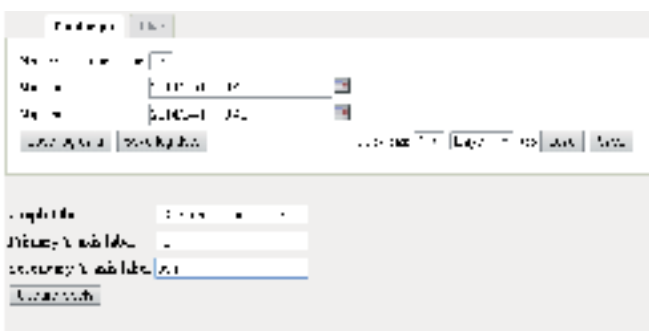

Fig. 10.e

Choosing the "Live" tab activates a real time graph of the variables, chosen from the list of public variables.

- Click "Show/Hide variables" to show the variable list (automatically populated by the c.pCO).
- Choose the variables to be displayed from the list
- Choose the sampling period (expressed in seconds) and the display interval (expressed in minutes)
- Click "Play" to start acquiring the data

In this case too, the graph can be adapted, even during the acquisition process.

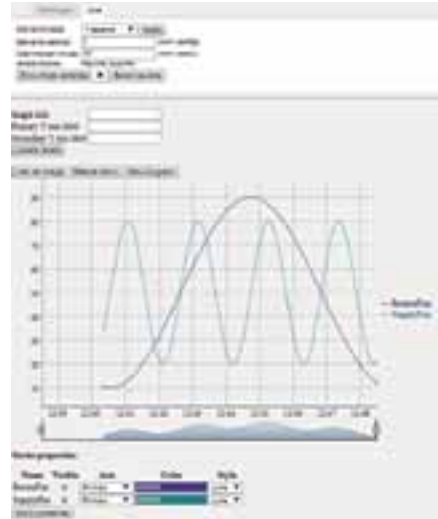

Fig. 10.f

10.6 c.pCO connection to cloud tERA

The c.pCO controllers family can establish a remote secure connection to the Carel cloud server platform called tERA. Every c.pCO with built-in Ethernet interface is natively integrated into tERa cloud platform and can access to linked services. Every c.pCO is uniquely identified by the tERA cloud using its MAC address. It is possible to create a customized private portal according to the customers specifications. For further information on tERA services available, contact your local Carel sales network.



Fig. 10.g

c.pCO registration:

Activation and registration procedure and settings of the tERA services are described in the "tERA Quick start Guide" (document +030222141), that can be download from www.carel.com.

Following data are requested in order to register a c.pCO in tERA server:

- MAC address of the c.pCO
- c.pCO Hardware unique ID
- tERA password

Above data are reported in the c.pCO System menu at the following path: INFORMATION --> pCO INFORMATION (see figure below).

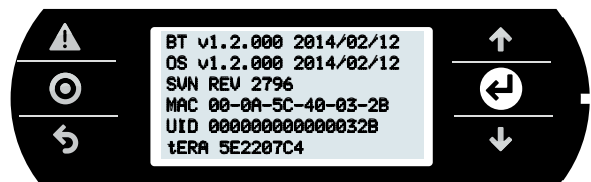

Fig. 10.h

c.pCO Update from tERA

From tERA portal, it is possible to update the application program and the Operating System of the c.pCO by remote. The controller should be already registered in the tERA portal.

Procedure is described in "tERA Quick start Guide" (document +030222141), that can be download from www.carel.com.

11. EXAMPLES

The following are a series of diagrams illustrating which devices can be connected to the c.pCO and the accessory cards required, depending on the type of application.

Air handling unit

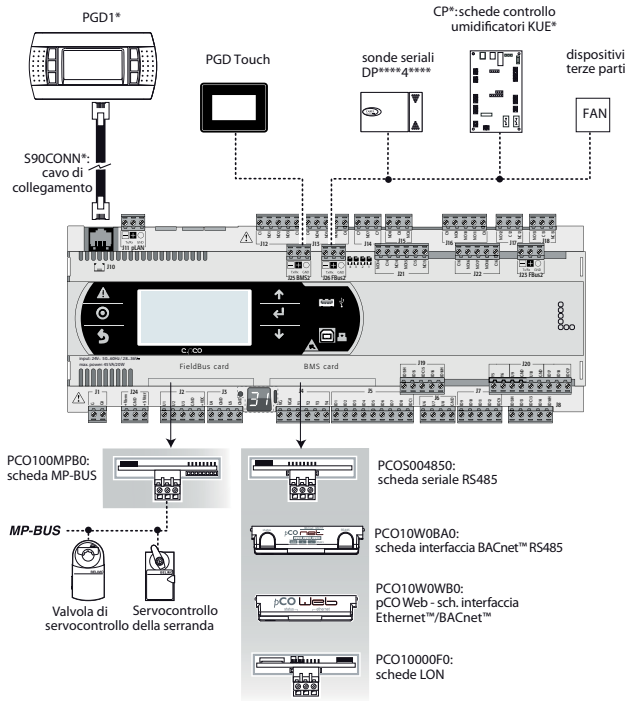

Fig. 11.a

Roof-top unit

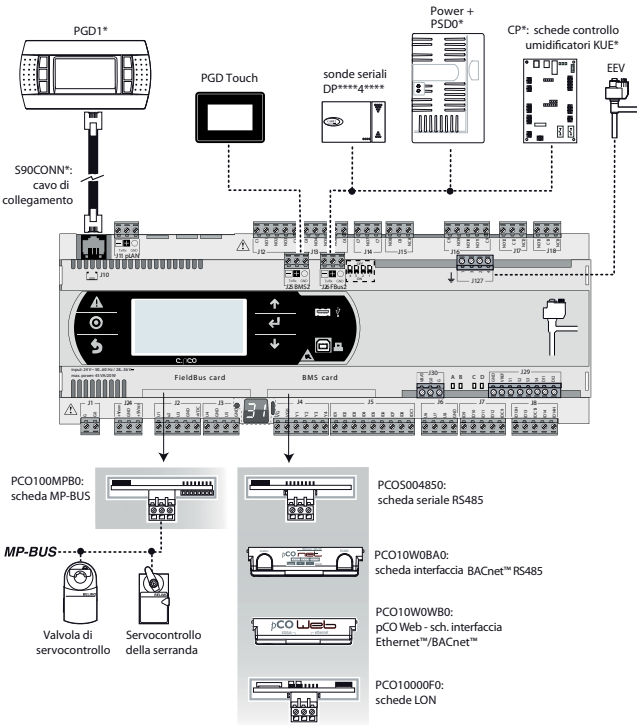

Fig. 11.b

Heat pump

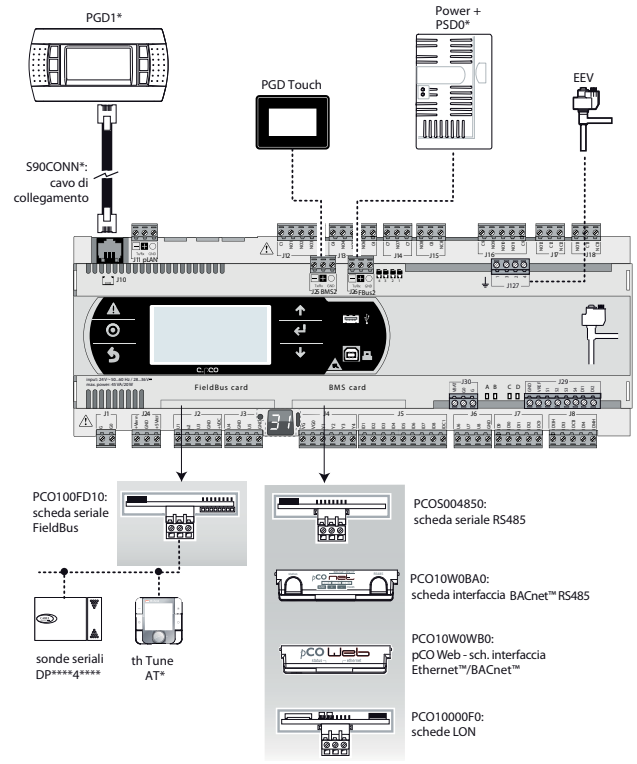

Fig. 11.c

Close control unit (CCU)

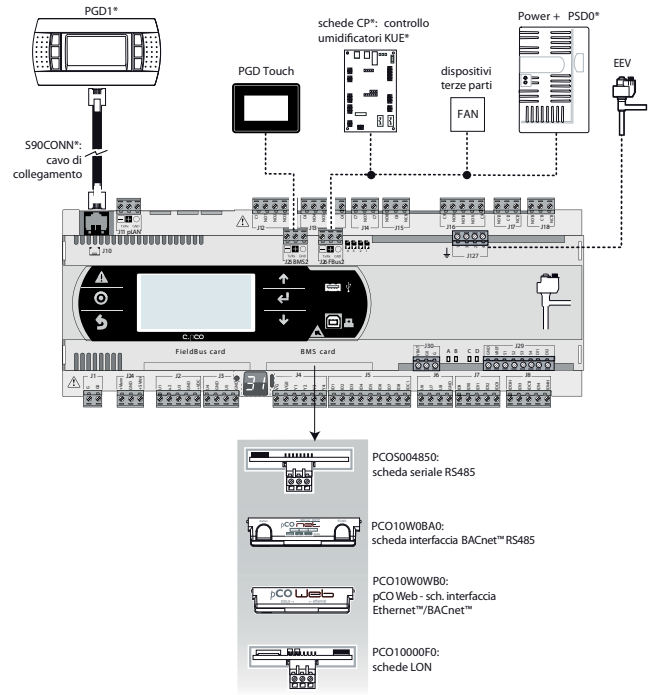
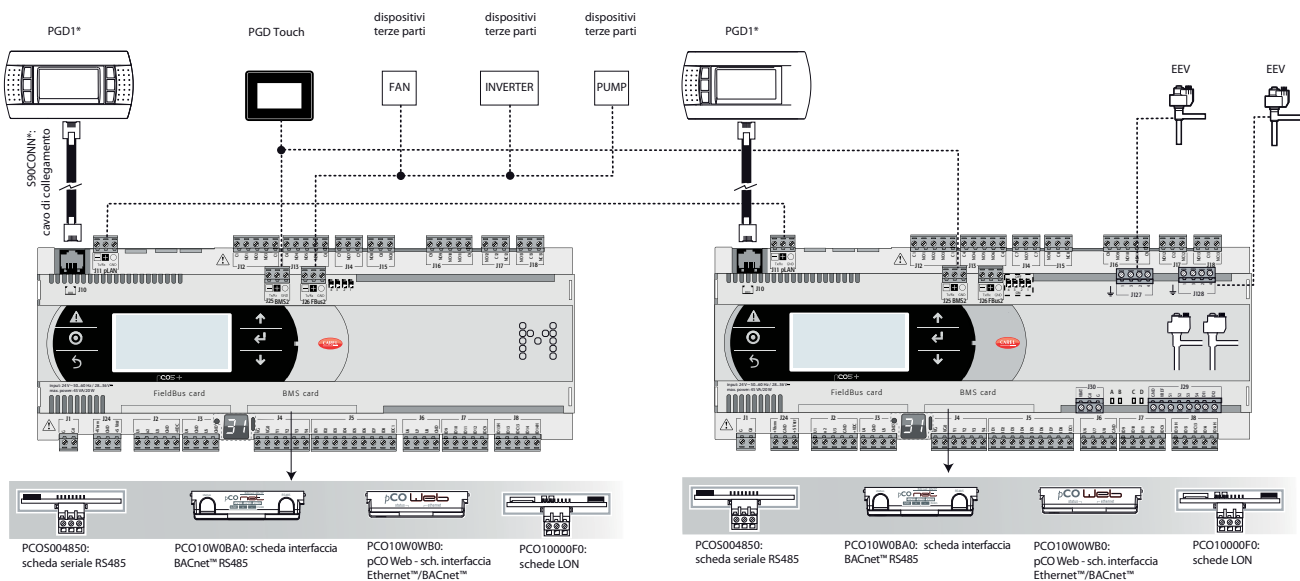

Fig. 11.d

Chiller - Screw compressor

To manage two refrigerant circuits, there are two options.

Case 1: 2 c.pCO Medium controller and c.pCO Medium with built-in electronic expansion valve driver.



Case 2: 1 c.pCO Large with external EVD Evolution twin driver.

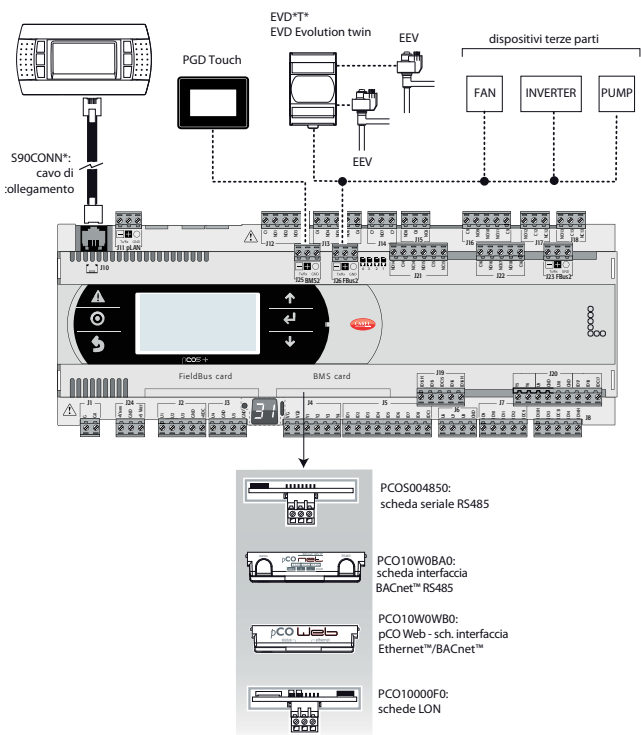

Chiller - Scroll compressor

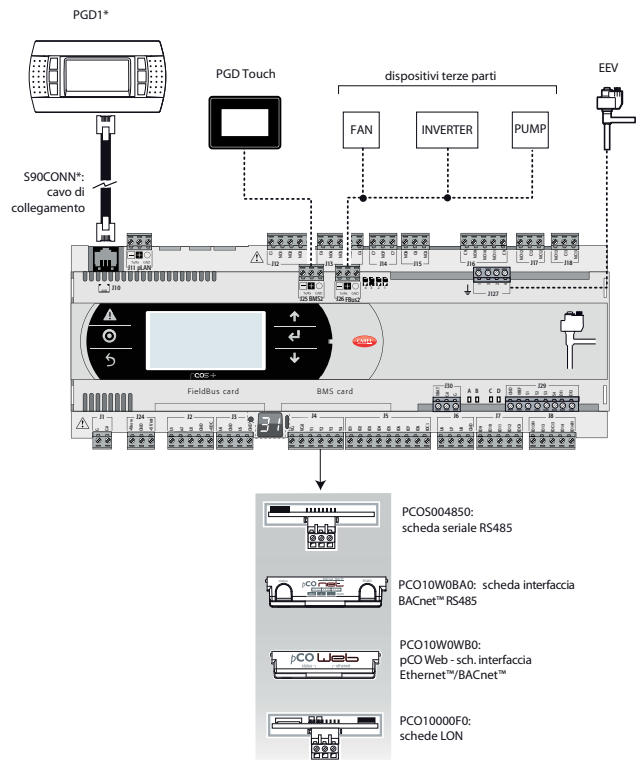

11.1 Devices that can be connected to the c.pCO

Device	seriale zero - pLAN o display port			seriale one - BMS1				seriale two - FBus 1		seriale three - BMS 2		seriale four - FBus 2		USB Master (Host)	USB Slave (Device)	Ethernet
	connector J11	connector J10	connector J3 Disp.	PCO5004850	PCO10000F0	PCO10W0WB0	PCO10W0BA0	PCO500KXB0	PCO100FD10	PCO500KXF0	connector J25	connector J6 BMS	connector J26 (and J23 su L-XL)			
pGD1 terminal		x	x													
PCOT - pCOI terminal (pGD1 version only)		x	x													
pLDPRO terminal		x	x													
EVD Evolution								x				x	x			
CAREL Slave devices (485)								x				x	x			
pCOexp 485								x				x	x			
c.pCOe								x				x	x			
PlantVisorPRO	x		x	x				x		x	x	x	x			
PlantWatchPRO	x		x	x				x		x	x	x	x			
PCGate	x		x	x				x		x	x	x	x			
WebGate	x		x	x				x		x	x	x	x			
GATEWAY**0	x		x	x				x		x	x	x	x			
LON - Echelon FTT10					x											
BACnet MS/TP (RS485)(*)							x			x		x				x
Konnex								x								
HTTP client						x										x
BACnet/Ethernet						x										
BACnet/IP						x										x
SNMP v1, SNMP v2C						x										
Modbus TCP/IP						x										x
Modbus supervisor (RTU)	x		x	x						x	x					
Modbus Slave devices									x			x	x			
Power +									x			x	x			
Pendrive (USB flash drive)														x		
PC Mass Storage																x
th-Tune terminal									x			x	x			
pGD Touch	x		x	x						x	x	x	x			

Tab. 11.a

(*) the BACnet MS/TP protocol is available on BMS2 / FBus2 / Ethernet, if the additional license is enabled on the controller (the protocol is active on 1 port at a time).

12. TECHNICAL SPECIFICATIONS

12.1 c.pCO technical specifications

Physical specifications

Dimensions	MINI	panel	147.3 x 81.3 x 70.5 mm
		4 DIN modules	70 x 110 x 63 mm
	SMALL	13 DIN modules	110 x 227,5 x 60 mm
	MEDIUM, LARGE, EXTRALARGE	18 DIN modules	110 x 315 x 60 mm
	BUILT-IN DRIVER	18 DIN modules	110 x 315 x 75 mm
Plastic case	Assembly	on DIN rail in accordance with DIN 43880 and IEC EN 50022 / or panel	
	Material	technopolymer	
	Flammability	V2 (UL94) and 850 °C (in accordance with IEC 60695)	
	Ball pressure test temperature	125 °C	
	Resistance to creeping current	≥ 250 V	
	Colour	White RAL 9016	
Built-in terminal	PGD1 (132x64 pixel) with backlit keypad		

Other specifications

Operating conditions	c.pCO: P+5**SE***0** (w/o built-in terminal): -40T70 °C, 90% RH non-condensing(*) c.pCOmini: P+(D)*****0** (w/o built-in terminal): -40T70 °C, 90% RH non-cond. c.pCO:P+5**SE***E** (with built-in term.): -20T60 °C, 90% RH non-condensing c.pCOmini: P+(D,P)*****E** (with built-in term.): -20T60 °C, 90% RH non-cond. (*) with Ultracap module fitted: -40T60°C
Storage conditions	c.pCO: P+5**SE***0** (w/o built-in terminal): -40T70 °C, 90% RH non-condensing c.pCOmini: P+(D)*****0** (w/o built-in terminal): -40T70 °C, 90% RH non-cond. c.pCO: P+5**SE***E** (with built-in terminal): -30T70 °C, 90% RH non-cond. c.pCOmini: P+(D,P)*****E** (with built-in terminal): -30T70 °C, 90% RH non-cond.
Ingress protection	c.pCO: IP20 on the front panel only c.pCOmini: P+P***** (panel): IP 65; P+D***** (DIN): IP 40
Controller pollution class	2
Class according to protection against electric shock	c.pCO: to be integrated into Class I and/or II equipment in versions without valve driver, Class I in versions with valve driver c.pCOmini: to be integrated into Class I and/or II equipment (Basic/Enhanced) - Class I (High-End)
PTI of insulating materials	PCB: PTI 250 V; insulating material: PTI 175
Period of electrical stress across the insulating parts	long
Type of action	1C; 1Y for SSR versions
Type of disconnection or microswitching	microswitching
Heat and fire resistance category	Category D (UL94-V2)
Ageing characteristics (operating hours)	80,000
No. of automatic operating cycles	100,000 (EN 60730-1); 30,000 (UL60730)
Rated impulse voltage	c.pCO: 2500V

Electrical specifications

Power supply

MINI, SMALL, MEDIUM, LARGE, EXTRALARGE: use a dedicated class II 50 VA safety transformer.

BUILT IN DRIVER: use a dedicated class II 100 VA safety transformer.

	Vac	P (Vac)	Vdc	P (Vdc)
MINI	24 Vac (+10/-15%), 50/60 Hz to be protected by 2.5 A T external fuse	30 VA (40 VA with Ultracap module)	28 to 36 Vdc (-20/+10%) to be protected by 2.5 A T external fuse	12 W
SMALL		45 VA		30 W
MEDIUM				
LARGE				
EXTRALARGE		90 VA	Not allowed	
BUILT-IN DRIVER				

⚠ Important: the c.pCO with built-in driver must be powered with alternating current and the secondary winding of the power supply transformer (G0) must be earthed; if the Ethernet connection is used, the transformer secondary winding (G0) must be earthed.

Terminal block	with plug-in male/female connectors
Cable cross-section	min 0.5 mm ² - max 2.5 mm ²
CPU	32 bit, 100 MHz
Non-volatile memory (FLASH)	128 Mbyte of which 90Mbyte available as File storage
Data memory (RAM)	16 Mbytes
Retain memory c.pCO/ c.pCO mini	31744 / 15360 bytes
Working cycle duration (application of average complexity)	0.2 s (typical)
Clock with battery	standard, precision: c.pCO/c.pCOmini: 100/ 50 ppm
Buzzer	can be software-enabled only via built-in terminal
Battery	c.pCO: 3 Vdc lithium button battery (24x3 mm), code CR2430 c.pCO 3 Vdc lithium button battery (20x3.2 mm), code BR2032
Software class and structure	Class A
Category of immunity to voltage surges (EN 61000-4-5)	c.pCO / c.pCOmini: Category III/II
Device not designed to be hand-held when powered	

Universal inputs/outputs U...

Analog inputs, Lmax = 30 m (max. number)

	MINI	SMALL	MEDIUM / BUILT-IN DRIVER / EXTRALARGE	LARGE
NTC CAREL probes (-50T90°C; R/T 10 kΩ±1% a 25°C); NTC HT (0T150°C); PTC (600Ω ...2200Ω) PT500 (-100T300°C) PT1000 (-100T400°C) PT100 probes (-100T400°C);	10	5	8	10
0...1 Vdc/0...10 Vdc signals from probes powered by the controller(*)	-	max tot 5 5	max tot 8 6	max tot 10 6
0...1 Vdc/0...10 Vdc signals from probes powered extern. (*)	10	5	8	10
0...20 mA /4...20 mA inputs from probes powered by the controller(*)	max tot 4 2	max tot 4 4	max tot 7 6 (max 4 su U1...U5, 3 su U6...U8)	max tot 9 6 (max 4 su U1...U5, 3 su U6...U8, 2 su U9...U10)
0...20 mA /4...20 mA inputs from probes powered extern. (*)	4	4	7 (max 4 su U1...U5, 3 su U6...U8)	9 (max 4 su U1...U5, 3 su U6...U8, 2 su U9...U10)
0...5 V signals from ratiometric probes powered by the controller (*)	2	5	6	6
Input accuracy: ± 0,3 % f.s.				
Time constant for each input: 0,5 s				
Classification of measuring circuits (CEI EN 61010-1): category I				
Universal IO: PWM 0-10V, 10 mA				

Non optically isolated digital inputs

	MINI	SMALL	MEDIUM / BUILT-IN DRIVER / EXTRALARGE	LARGE
Lmax	30 m	30 m	30 m	30 m
voltage-free contacts	10	5	8	10
fast digital inputs : Type: voltage-free contacts; Max. current: 10 mA; Max. frequency 2kHz and resolution ±1 Hz	max 2	max 2	4 (max 2 su U1...U5, max 2 su U6...U8)	6 (max 2 su U1...U5, max 2 su U6...U8, 2 su U9...U10)

⚠ Warning:

- To avoid irreparably damaging the controller, externally powered active probes (0...1 V, 0...10V, 0...20 mA, 4...20 mA) should be provided with adequate current protection and the current should be < 100 mA
- Ratiometric probes can be powered by the controller only.
- At power on, universal inputs/outputs are short circuited to GND for about 500ms up to the end of the configuration.

	MINI	SMALL	MEDIUM/ BUILT-IN DRIVER/EXTRALARGE	LARGE
0 to 10 Vdc (*) (max. current 2 mA)	5	5	8	10
• PWM (0/3.3 Vdc output, max. current 2 mA, frequency: 2kHz asynchronous, 100 Hz asynchronous)				
• c.pCOmini: PWM (0/10 Vdc output, 10 mA max. current. Frequency: 2 kHz synchronous, 100 Hz asynchronous). Duty Cycle set by application software in the range: 0% - 10%...90% - 100%	10	5	8	10

Power supply for probes and terminals

+Vdc	c.pCO: Active probes can be powered by the 24/21 Vdc ±10% available on terminal +VDC (J2). The max. available current is 150 mA, protected against short-circuits. c.pCOmini: 12 Vdc ± 8%; maximum current is 50 mA, protected against short-circuits.
+5Vref	c.pCO: To power the 0 to 5 V ratiometric probes use the 5 Vdc (±5%) available on terminal +5VREF(J24). The max. available current is 60mA. c.pCOmini: +5VREF = 5 Vdc ± 3%; maximum current is 50 mA, protected against short-circuits.
Vterm	c.pCO: 24 Vdc ± 10% To be used to power an external terminal in alternative to the one connected to J10, Pmax = 1.5 W - Warning: For lengths greater than 10 m use a shielded cable with earthed shield. In any case the max. allowable length is 30 m. c.pCOmini: 24...36 Vdc ± 5% depending of power supply; max available current: 100 mA (pGD1, pLDPRO, thTUNE CAREL), protected against short-circuits. Maximum cable length: 10 m.

Digital inputs ID... IDH

Type	c.pCO Small...Extralarge optically-isolated; c.pCOmini not optically-isolated		
Lmax	30 m, (c.pCOmini 10m)		
		Voltage-free contacts	no. of optically-isolated inputs at 24 Vac or 24 Vdc
Maximum number	MINI (only Enhanced/HighEnd)	2	0
	SMALL	0	8
	MEDIUM/ BUILT-IN DRIVER/EXTRALARGE	0	12
	LARGE	0	14
Minimum digital input pulse detection time	Normally open (open-closed-open): 200 ms; Normally closed (closed-open-closed): 400 ms;		
Power supply to inputs	c.pCO Small...Extralarge - External - c.pCOmini - Internal IDH...: 230 Vac (+10/-15%) 50/60 Hz ID...: 24 Vac (+10/-15%) 50/60 Hz or 28-36 Vdc (+10/-20%)		
Classification of measuring circuits (EN 61010-1)	Category I: 24 Vac/Vdc (J5, J7, J20) Category III: 230 Vac (J8, J19)		
Digital input current draw at 24 Vac/Vdc	5 mA		
Digital input current draw at 230 Vac	5 mA		



Important:

c.pCO SMALL, MEDIUM, BUILT-IN DRIVER, LARGE, EXTRALARGE:

- separate as much as possible the probe and digital input cables from cables to inductive loads and power cables, so as to avoid possible electromagnetic disturbance. Never run power cables (including the electrical panel cables) and signal cables in the same conduits;
- the two 230 Vac or 24 Vac/Vdc inputs on terminals J8 (ID13, ID14) or J19 (ID15, ID16) have the same common pole and must therefore be powered at the same voltage (230 Vac or 24 Vac/Vdc). There is functional insulation between the two inputs; there is reinforced insulation between the inputs and the rest of the controller;
- ID1...ID8, ID9 to ID12, ID17, ID18 have functional insulation from the rest of the controller;
- for DC voltage inputs (24 Vdc) either the + or the - can be connected to common terminal;
- the rating of the external contact connected to the digital inputs must be at least 5 mA.

c.pCOmini

- separate as much as possible the probe and digital input cables from cables to inductive loads and power cables, so as to avoid possible electromagnetic disturbance. Never run power cables (including the electrical panel cables) and signal cables in the same conduits;
- the rating of the external contact connected to the digital inputs must be at least 5 mA.

Analogue outputs Y...

	MINI	SMALL	MEDIUM / BUILT-IN DRIVER / EXTRALARGE	LARGE
Type	0...10 V no optically-isolated, su Y1, Y2	0...10 V optically-isolated on Y1...Y6		
Lmax	10m	30 m		
Maximum number	2: Y1, Y2	4: Y1...Y4 a 0...10 V		6: Y1...Y6 a 0...10 V
Power supply	Internal	external: 24 Vac (+10/-15%) o 28...36 Vdc su VG(+), VG0(-) (*)		
Precision	Y1, Y2 ± 3% full scale	Y1...Y6: ± 2% full scale		
Resolution	8 bit	8 bit		
Settling time	Y1, Y2: da 1 s (slew rate 10 V/s) a 20 s (slew rate 0,5 V/s) selectable via SW	Y1...Y6: da 1 s (slew rate 10 V/s) a 20 s (slew rate 0,5 V/s) selezionabile via SW		
Maximum load	1 kΩ (10 mA)	1 kΩ (10 mA)		



Warnings - c.pCO SMALL, MEDIUM, BUILT-IN DRIVER, LARGE, EXTRALARGE

- for lengths greater than 10 m use a shielded cable with earthed shield;
- a 0 to 10Vdc analogue output can be connected in parallel to other outputs of the same kind, or alternatively to an external source of voltage. The higher voltage will be considered. Correct operation is not guaranteed if actuators with voltage inputs are connected;
- power the VG-VG0 analogue outputs at the same voltage on G-G0: connect G to VG and G0 to VG0. This applies in case of both alternating or direct current power supplies.

c.pCOmini

- for lengths greater than 10 m use a shielded cable with earthed shield;
- a 0 to 10Vdc analogue output can be connected in parallel to other outputs of the same kind, or alternatively to an external source of voltage. The higher voltage will be considered. Correct operation is not guaranteed if actuators with voltage inputs are connected;

Digital outputs NO..., NC...

c.pCOmini

Maximum connection cable length: less than 30 m										
Type	Relay.									
Maximum no.	6									
Insulation distance	The outputs can be divided into groups: between group 1 and 2 there is basic insulation. Group 3 has reinforced insulation from the first 2 groups and can be powered at a different voltage. Relays with same insulation									
Composition of groups	Model	1	2	3						
	MINI	1...2	3, 4, 5	6						
Type of relay	Type C	Type C	Type D							
Number of changeover contacts	1 (relay 6)									
Switchable power	Type C	Relay rating								
		Approval		NO EN 60730-1:	2(1)A (75000 cycles)					
				UL 60730:	5 A resistive, 250 Vac, 30000 cycles, 105 °C. Defined purpose, 1FLA, 6LRA, 250 Vac, 30000 cycles, 105 °C, pilot duty C300, 250 Vac, 30000 cycles, 105 °C					
	Type D	Relay rating								
		Approval		NO EN 60730-1:	1(1)A (100000 cycles), maximum switchable voltage: 250 Vac					
				UL 60730-1:	1 A resistive, 1 A FLA, 6 A LRA, 250 Vac, D300 pilot duty, 30000 cycles					
R2, R5 with SSR assembly: switchable power 15 VA 110/230 Vac or 15 VA 24 Vac according to the model purchased										

c.pCO SMALL, MEDIUM, BUILT-IN DRIVER, LARGE, EXTRALARGE

Type	Relay. Min. contact current: 50 mA.											
Maximum no.	8: SMALL; 13: MEDIUM/ BUILT-IN DRIVER; 18: LARGE; 29: EXTRALARGE											
Insulation distance	The relay outputs have different features depending on the controller model. The outputs can be divided into groups. Relays belonging to the same group (individual cell in the table) have operational insulation and must therefore be powered at the same voltage. Between groups (between cells in the table) there is reinforced insulation, so the relays can be powered at different voltages. There is also reinforced insulation between each terminal of the digital outputs and the rest of the controller.											
	Relays with same insulation											
		Group										
Composition of groups	Model	1	2	3	4	5	6	7	8	9	10	11
	SMALL	1...3	4...6	7	8	-	-	-	-	-	-	-
	Type of relay	Type A	Type A	Type A	Type A	-	-	-	-	-	-	-
	MEDIUM/ BUILT-IN DRIVER	1...3	4...6	7	8	9...11	12	13	-	-	-	-
	Type of relay	Type A	Type A	Type A	Type A	Type A	Type A	Type A	Type A	-	-	-
	LARGE NO	1...3	4...6	7	8	9...11	12	13	14...15	16...18	-	-
Type of relay	Type A	Type A	Type A	Type A	Type A	Type A	Type A	Type A	Type A	Type B	Type B	
EXTRALARGE	1...3	4...6	7	8	9...11	12	13	14...16	17...20	21...24	25...29	
Type of relay	Type A	Type A	Type A	Type A	Type A	Type A	Type A	Type B	Type B	Type B	Type B	
Number of changeover contacts	1: SMALL (relay 8)			3: MEDIUM and EXTRALARGE (relay 8, 12, 13)			5: LARGE NO (relay 8, 12, 13, 14 and 15)					

Note: output relays have different features depending on the model of

Switchable power	Type A relay	Rated data	SPDT, 2000 VA, 250 Vac, 8A resistive	
		Approval	UL60730	2 A resistive, 250 Vac, 30,000 cycles Pilot duty C300, 240Vac, 30,000 cycles
	Type B relay	Rated data	SPST, 1250 VA, 250 Vac, 5A resistive	
		Approval	UL60730	1 A resistive, 250 Vac, 30,000 cycles Pilot duty C300, 240Vac, 30,000 cycles
SSR outputs (on models where provided)	Maximum number	1: SMALL (output 7); 2: MEDIUM and EXTRALARGE (outputs 7 and 12); 3 or 4: LARGE 3 SSR (output 7, 12, 14) LARGE 4 SSR (output 7, 8, 12, 13)		
	Working voltage	24 Vac/Vdc SELV		
	Load current (MAX)	1 A		
	Pulse load current (MAX)	1,2 A		

Warning:

- if the load requires a higher current, use an external SSR. To power external loads, use the same power supply as the pCO (connected to terminals G-G0); this must always be dedicated and not in common with the power supply to other devices (e.g. contactors, coils, etc.);
 - to simplify wiring, the groups of digital outputs have two common pole terminals;
 - make sure that the current running through the common terminals does not exceed the rated current of each terminal, i.e. 8A.
- (* class 2

Serial ports (for +/- use AWG 20-22 twisted pair shielded cable)

Serial	Type/connectors	Features
Serial 0	pLAN/J10, J11	<ul style="list-style-type: none"> Integrated on main board HW driver: asynchronous half duplex RS485 pLAN Not optically-isolated Connectors: 6-pin telephone jack + 3-pin plug-in, 5.08 pitch
Serial ONE	BMS 1 Serial Card	<ul style="list-style-type: none"> Not integrated on main board HW driver: not present
Serial TWO	FieldBus 1 Serial Card	<ul style="list-style-type: none"> Not integrated on main board HW driver: not present
Serial THREE	BMS 2 / J25	<ul style="list-style-type: none"> Integrated on main board HW driver: asynchronous half duplex RS485 Slave Optically-isolated/not optically-isolated serial (*) 3-pin plug-in connector, 5.08 pitch
Serial FOUR	FieldBus 2 / J26 (and J23 on Large and Extralarge version)	<ul style="list-style-type: none"> Integrated on main board HW driver: asynchronous half duplex RS485 Master/Slave (**) J23: not optically-isolated

(*): both models are available; (**): port J26 can be configured: see par. 3.2.



Note: in industrial/residential applications with distances greater than 10 m, use shielded cable with earthed shield.

In residential applications (EN 55014), regardless of cable length, in versions without valve driver, the connection cable between controller and terminal and the serial cable must be shielded and earthed on both sides.

Ethernet	RJ45 connector	c.pCOmini High End	one 10/100 Mbps Ethernet port
		cpCO Small...Extralarge	two equivalent 10/100 Mbps Ethernet ports (100-BASE TX standard)

c.pCOmini

Single-pole valve output

Type	Relay. Min. contact current: 50 mA.
Number of valves:	1
Maximum output for each valve	8 W
Type of control	Single-pole
Valve connector	6-pin, fixed sequence
Power supply	13 V ± 5%
Maximum current	0.35 A for each winding
Minimum winding resistance	40 Ω
Max connection cable length	Residential/industrial environments: 2 m without shielded cable, or with shielded cable earthed at both ends (E2VCABS3U0, E2VCABS6U0)
	Residential environment: 2 m without shielded cable

c.pCO: Model with electronic expansion valve driver

Compatible valves	CAREL: E*V**** ALCO: EX4; EX5; EX6; EX7; EX8 330 Hz (recommended by CAREL); EX8 500 Hz (as per ALCO specifications) SPORLAN: SEI 0.5-11; SER 1.5-20; SEI 30; SEI 50; SEH 100; SEH175 Danfoss: ETS 12.5-25B; ETS 50B; ETS 100B; ETS 250; ETS 400 CAREL: Two CAREL EXVs as for EVD EVOLUTION TWIN SPORLAN: SER(I) G, J, K		
Motor connection	Shielded 4-wire cable CAREL P/N E2VCABS*00, or shielded 4-wire cable AWG22 Lmax =10 m, or shielded 4-wire cable AWG14 Lmax 50 m		
Connection digital inputs	Digital input to be activated with voltage-free contact or transistor to GND. Closing current 5 mA; maximum length < 10 m		
Probes	Maximum length 10 m or less than 30 m with shielded cable		
	S1	ratiometric pressure probe (0 to 5 V) electronic pressure sensor (4 to 20 mA) combined ratiometric pressure probe (0 to 5 V) 4 to 20 mA input (max. 24 mA)	resolution 0.1 % FS resolution 0.5 % FS resolution 0.1 % FS resolution 0.5 % FS
			measurement error: 2% FS maximum; 1% typical measurement error: 8% FS maximum; 7% typical measurement error: 2 % FS maximum; 1 % typical measurement error: 8 % FS maximum; 7 % typical
	S2	low temperature NTC high temperature NTC combined NTC	10 kΩ at 25 °C, -50T90 °C 50 kΩ at 25 °C, -40T150 °C 0 kΩ at 25 °C, -40T120 °C
			measurement error: 1°C in the range -50T50 °C; 3 °C in the range +50T90 °C measurement error: 1.5 °C in the range -20T115 °C, 4 °C in range outside of -20T115 °C measurement error: 1°C in the range -40T50 °C; 3 °C in the range +50T90 °C
	S3	0 to 10 V input (max 12 V) ratiometric pressure probe (0 to 5 V): electronic pressure sensor (4 to 20 mA) combined ratiometric pressure probe (0 to 5 V) 4 to 20 mA input (max. 24 mA)	resolution 0.1% FS resolution 0.1 % FS resolution 0.5 % FS; resolution 0.1 % FS resolution 0.5 % FS
			measurement error: 9% FS maximum; 8% typical measurement error: 2% FS maximum; 1% typical measurement error: 8% FS maximum; 7% typical measurement error: 2 % FS maximum; 1 % typical measurement error: 8 % FS maximum; 7 % typical
	S4	low temperature NTC high temperature NTC combined NTC	10 kΩ at 25 °C, -50T105 °C; 0 kΩ at 25 °C, -40T150 °C 10 kΩ at 25 °C, -40T120 °C
			measurement error: 1 °C in the range -50T50 °C; 3°C in the range 50T90 °C measurement error: 1.5 °C in the range -20T115 °C; 4 °C in range outside of -20T115 °C measurement error 1 °C in the range -40T50 °C; 3 °C in the range +50T90 °C
Power to active probes (VREF)	Programmable output: +5 Vdc ±2% or 12 Vdc ±10%, I _{max} = 50 mA		
Emergency power supply	Optional Ultracapacitor module (PCOS00UC20 or EVD0000UC0). If the controller works constantly at temperatures near the upper limit of 60°C it is recommended to use the external module P/N EVD0000UC0, if possible placed in the coolest point of the panel. Modules PCOS00UC20 and EVD0000UC0 can be connected to the same controller at the same time, thereby doubling the energy available for closing the valves. Important: the module only powers the valve driver and not the controller.		

Standards compliance

Electrical safety	EN 60730-1, EN 60730-2-9, EN 61010-1, UL60730
Electromagnetic compatibility	Versions without valve driver: EN 61000-6-1, EN 61000-6-2, EN 61000-6-2/EC, EN 61000-6-2/IS1, EN 61000-6-3, EN 61000-6-4; EN 55014-1, EN 55014-2, EN 55014-2/EC, EN 55014-2/A1, EN 55014-2/IS1, EN 55014-2/A2 Versions with valve driver with or without Ultracap module: EN 61000-6-1, EN 61000-6-2, EN 61000-6-2/EC, EN 61000-6-2/IS1, EN61000-6-3, EN 61000-6-4

c.pCO connectors

Electrical specifications of the plug-in connectors used:

Connector type	5.08 mm pitch
Cable size	0.25 mm ² - 2.5 mm ² (AWG: 24 to 12)
Stripped length	7 mm
Screw thread	M3
Tightening torque	0.5 to 0.6 Nm

Correspondence between AWG and cable cross-section

AWG	Cross-section (mm ²)	Max current
20	0.5	2
15	1.5	6
14	2.5	8

12.2 FTP commands

The operating system supports a subset of FTP commands, as shown in the following table.

FTP command	Description	FTP command	Description
CDUP	Change to parent directory	RETR	Retrieve
CWD	Change working directory	RMD	Remove directory
DELE	Delete	SIZE	Size of the file
LIST	List	STOR	Store
MKD	Make directory	SYST	System
NLST	Name list	TYPE	Representation type
NOOP	No operation	USER	User name
PASS	Password	XCUP	Change to parent directory
PASV	Passive	XMKD	Make directory
PORT	Data port	XPWD	Print the current working directory
PWD	Print the current working directory	XRMD	Remove directory



Note: refer to RFC 959 specifications for a detailed and complete description of FTP commands.

CAREL

CAREL INDUSTRIES - Headquarters
Via dell'Industria, 11 - 35020 Brugine - Padova (Italy)
Tel. (+39) 049.9716611 - Fax (+39) 049.9716600
e-mail: carel@carel.com - www.carel.com

Agenzia / Agency: