

EVT330

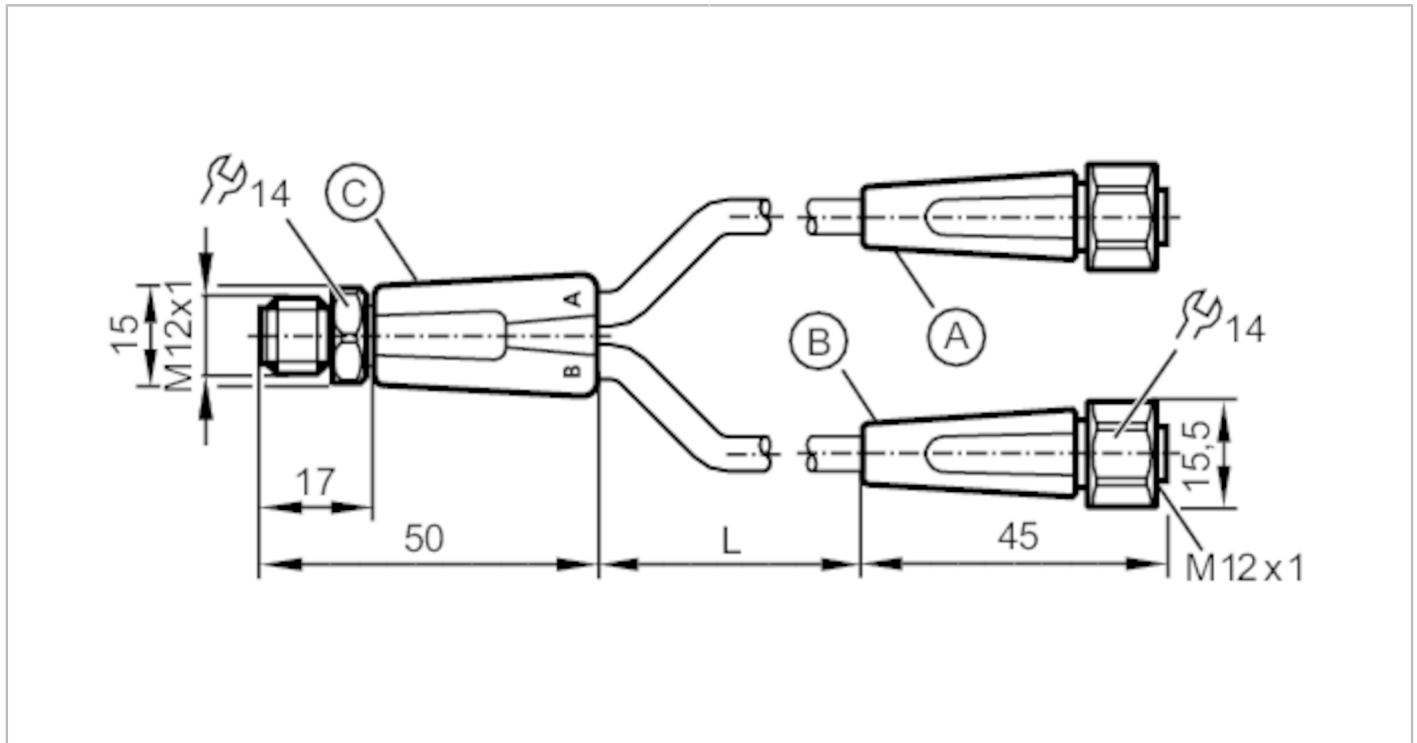

Y connection cable

YDOGH040VAS0002E04STGH050VAS



Application	
System	Free from silicone; gold-plated contacts; Drag chain suitability
Application	sanitary and wet areas in the food industry
Free from silicone	yes
Electrical data	
Operating voltage [V]	< 60 AC/DC
Protection class	II
Max. current load total [A]	4
Overall current rating (UL) [A]	3
Operating conditions	
Ambient temperature [°C]	-25...100
Note on ambient temperature	cULus: ...50
Ambient temperature (moving) [°C]	5...100
Note on ambient temperature (moving)	cULus: ...50
Storage temperature [°C]	-25...55
Storage humidity [%]	10...100
Other climatic conditions for storage according to stated class	1K22/ DIN 60721-3-1
Protection	IP 65; IP 67; IP 68; IP 69K

EVT330



Y connection cable

YDOGH040VAS0002E04STGH050VAS

Mechanical data		
Weight [g]	190.9	
Molded-body material	PVC	
Material nut	stainless steel (1.4404 / 316L)	
Sealing material	EPDM	
Number of ports splitter box	2	
Drag chain suitability	yes	
Drag chain suitability	Bending radius for flexible applications	min. 10 x cable diameter
	Travel speed	max. 3.3 m/s for a horizontal travel length of 5 m and max. acceleration of 5 m/s ²
	Bending cycles	> 1 Mio.
	Torsional strain	± 180 °/m

Remarks	
Pack quantity	1 pcs.

Electrical connection	
Cable: 2 m, PVC, orange, Ø 4.9 mm; 4 x 0.34 mm ² (42 x Ø 0.1 mm)	

Electrical connection - Socket	
Connector: 2 x M12, straight; coding: A; Moulded body: PVC, orange; Locking: stainless steel (1.4404 / 316L); sealing: EPDM; Contacts: gold-plated; Tightening torque: 0.6...1.5 Nm	

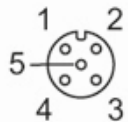

Electrical connection - plug	
Connector: 1 x M12, straight; coding: A; Moulded body: PVC, orange; Locking: stainless steel (1.4404 / 316L); Contacts: gold-plated; Tightening torque: 0.6...1.5 Nm	

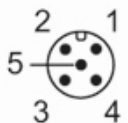

EVT330



Y connection cable

YDOGH040VAS0002E04STGH050VAS

Connection

