

RES-406 ^{GB}

Operating instructions



Important features

- Microprocessor technology
- Complete control via PROFIBUS-DP interface
- Automatic zero calibration (AUTOCAL)
- Automatic optimization (AUTOTUNE)
- Automatic configuration of the secondary voltage and current ranges (AUTORANGE, as of February 2006)
- Automatic phase angle compensation (AUTOCOMP, as of February 2006)
- Automatic frequency adjustment
- Large current and voltage range
- Booster connection as standard
- 0...10VDC analog output for ACTUAL temperature
- Alarm function with fault diagnosis
- Heatsealing band alloy and temperature range selectable

Contents

1	Safety and warning notes	3	10	Controller functions	21
1.1	Use	3	10.1	Indicators and controls	21
1.2	Heatsealing band	3	10.2	PROFIBUS communication „up to Jan. 2006“/“as of Feb. 2006“	23
1.3	Impulse transformer	3	10.3	Device master file (GSD)	23
1.4	Current transformer PEX-W2/-W3	3	10.4	PROFIBUS protocol	24
1.5	Line filter	4	10.5	Input data	26
1.6	Standards / CE marking	4	10.6	Output data	28
1.7	Warranty provisions	4	10.7	Parameter data	30
2	Application	4	10.8	DPV1 protocol extension (as of GSD Version v2.0)	35
3	Principle of operation	5	10.9	Temperature indication (actual value output)	38
4	Description of the controller	6	10.10	Booster connection	39
5	Accessories and modifications	6	10.11	Diagnostic interface/visualization software (as of February 2006)	39
5.1	Accessories	6	10.12	Total cycle counter (as of February 2006)	39
5.2	Modifications (MODs)	7	10.13	Operating hours counter (as of February 2006)	39
6	Technical data	8	10.14	Log function (as of software revision 107)	40
7	Dimensions	10	10.15	System monitoring/alarm output	40
8	Installation	10	10.16	Error messages	41
8.1	Installation procedure	10	10.17	Fault areas and causes	46
8.2	Installation steps	11	11	Factory settings	47
8.3	Power supply	12	12	Maintenance	48
8.4	Line filter	13	13	How to order	49
8.5	Current transformer PEX-W3	13	14	Index	50
8.6	Wiring diagram (standard)	14			
8.7	Wiring diagram with booster connection	15			
9	Startup and operation	16			
9.1	View of the controller	16			
9.2	Controller configuration	16			
9.3	Replacing and "burning in" the heatsealing band	18			
9.4	Startup procedure	19			

1 Safety and warning notes

This RESISTRON temperature controller is manufactured according to DIN EN 61010-1. In the course of its manufacture it passed through quality assurance, whereby it was subjected to extensive inspections and tests.

It left the factory in perfect condition.

The recommendations and warning notes contained in these operating instructions must be complied with, in order to guarantee safe operation.

The device can be operated within the limits indicated in the "Technical Data" without impairing its operational safety. Installation and maintenance may only be performed by technically trained, skilled persons who are familiar with the associated risks and warranty provisions.

1.1 Use

RESISTRON temperature controllers may only be used for heating and temperature control of heatsealing bands which are expressly suitable for them, and providing the regulations, notes and warnings contained in these instructions are complied with.

 **In case of non-compliance or use contrary to the intended purpose, there is a risk that safety will be impaired or that the heatsealing band, electrical wiring, transformer etc. will overheat. Ensuring such compliance is the personal responsibility of the user.**

1.2 Heatsealing band

A basic prerequisite for reliable and safe operation of the system is the use of suitable heatsealing bands.

 **The resistance of the heatsealing band which is used must have a positive minimum temperature coefficient in order to guarantee trouble-free operation of the RESISTRON temperature controller.**

The temperature coefficient must be specified as follows:

$$\bar{CR} \geq 10 \times 10^{-4} \text{K}^{-1}$$

e.g. Alloy-20: TCR = 1100 ppm/K
NOREX: TCR = 3500 ppm/K

The RESISTRON temperature controller must be set and coded according to the temperature coefficient of the heatsealing band.

 **The use of incorrect alloys with a too low temperature coefficient and incorrect coding of the RESISTRON temperature controller lead to uncontrolled heating and ultimately to burn-out of the heatsealing band!**

The heatsealing bands that were originally supplied must be identified by detail specification, part number or some other means that will assure that replacement bands are identical.

1.3 Impulse transformer

A suitable impulse transformer is necessary to ensure that the control loop functions perfectly. This transformer must be designed according to VDE 0570/EN 61558 (isolating transformer with reinforced insulation) and have a one section bobbin. When the impulse transformer is installed, suitable shock protection must be provided in accordance with the national installation regulations for electrical equipment. In addition, water, cleaning solutions and conductive fluids must be prevented from seeping into the transformer.

 **Incorrect installation of the impulse transformer impairs electrical safety.**

1.4 Current transformer PEX-W2/W3

The current transformer supplied with the RESISTRON temperature controller is an integral part of the control system.

 **Only the original ROPEX PEX-W2 or PEX-W3 current transformer may be used. Other transformers may cause the equipment to malfunction.**

The current transformer may only be operated if it is connected to the RESISTRON temperature controller correctly (see section 9, "Startup and operation"). The relevant safety instructions contained in section 8.3, "Power supply", must be obeyed. External monitoring modules can be used in order to additionally increase

operating safety. They are not included in the scope of supply of the standard control system and are described in a separate document.

1.5 Line filter

The use of an original ROPEX line filter is mandatory in order to comply with the standards and provisions mentioned in section 1.6 "Standards / CE marking" on page 4. This device must be installed and connected according to the instructions contained in section 8.3, "Power supply" as well as the separate documentation enclosed with the line filter.

1.6 Standards / CE marking

The controller described here complies with the following standards, provisions and directives:

DIN EN 61010-1:2001 (2006/95/EG)	Safety requirements for electrical equipment for measurement, control and laboratory use (low-voltage directive): pollution degree 2, protection class II, measurement category I (for U_R and I_R terminals)
DIN EN 60204-1 (2006/42/EG)	Electrical equipment of machines (machinery directive)
EN 55011:1998 + A1:1999 + A2:2002 EN 61000-3-2:2006-04 EN 61000-3-3:1995-01 + A1:2001 + A2:2005-11 (2004/108/EG)	EMC genery emissions: Group 1, Class A
EN 61000-6-2:2005 (2004/108/EG)	EMC generic immunity: Class A (ESDs, RF radiation, bursts, surges) <u>Exception:</u> Line voltage interruption acc. EN 61000-4-11 is not fulfilled (This leads to a designated error message of the controller)

2 Application

This RESISTRON temperature controller is an integral part of the "Series 400", the outstanding feature of which is its microprocessor technology. All RESISTRON temperature controllers are used to control the temperature of heating elements (heatsealing bands, beaded bands, cutting wires,

Compliance with these standards and provisions is only guaranteed if original accessories and/or peripheral components approved by ROPEX are used. If not, then the equipment is operated on the user's own responsibility.

The CE marking on the controller confirms that the device itself complies with the above-mentioned standards.

It does not imply, however, that the overall system also fulfils these standards.

It is the responsibility of the machine manufacturer and of the user to verify the completely installed, wired and operationally ready system in the machine with regard to its conformity with the safety provisions and the EMC directive (see also section 8.3, "Power supply"). If peripheral components (e.g. the transformer or the line filter) from other manufacturers are used, no functional guarantee can be provided by ROPEX.

1.7 Warranty provisions

The statutory provisions for warranties apply for a period of 12 months following the delivery date.

All devices are tested and calibrated in the factory. Devices that have been damaged due to faulty connections, dropping, electrical overloading, natural wear, incorrect or negligent handling, chemical influences or mechanical overloading as well as devices that have been modified, relabeled or otherwise altered by the customer, for example in an attempt to repair them or install additional components, are excluded from the warranty.

Warranty claims must be examined in the factory and approved by ROPEX.

heatsealing blades, solder elements etc.), as required in a variety of heatsealing processes.

The controller is most commonly used for impulse-heatsealing PE films in:

- Vertical and horizontal f/f/s machines
- Pouch, filling and sealing machines

- Film wrapping machines
- Pouch-making machines
- Group packaging machines
- etc.

The use of RESISTRON temperature controllers results in:

- Repeatable quality of the heatseals under any conditions
- Increased machine capacity
- Extended life of the heatsealing bands and teflon coatings
- Simple operation and control of the sealing process

3 Principle of operation

The resistance of the heatsealing band, which is temperature-sensitive, is monitored 50x per second (60x at 60Hz) by measuring the current and voltage. The temperature calculated with the help of these measurements is displayed and compared with the set point.

The primary voltage of the impulse transformer is adjusted by phase-angle control, if the measured values deviate from the set point. The resulting change in the current through the heatsealing band leads to a change in the band temperature and thus also its resistance. This change is measured and evaluated by the RESISTRON temperature controller.

The control loop is closed: ACTUAL temperature = SET temperature. Even minute thermal loads on the heatsealing band are detected and can be corrected quickly and precisely.

A highly high response thermo-electric control loop is formed which is highly accurate because purely electrical variables are measured at a high sampling rate. A high secondary current can be controlled because power is controlled on the primary side of the

transformer. This allows optimum adaptation to the load and to the required dynamic range despite the exceptionally compact dimensions of the controller.

PLEASE NOTE!

RESISTRON temperature controllers play a significant role in enhancing the performance of modern machines. However, the full benefit can only be obtained from the advanced technology offered by this control system if all the system components, in other words the heatsealing band, the impulse transformer, the wiring, the timing signals and the controller itself, are carefully compatible and interrelated.

We will be pleased to contribute our many years of experience towards optimizing *your* heatsealing system.

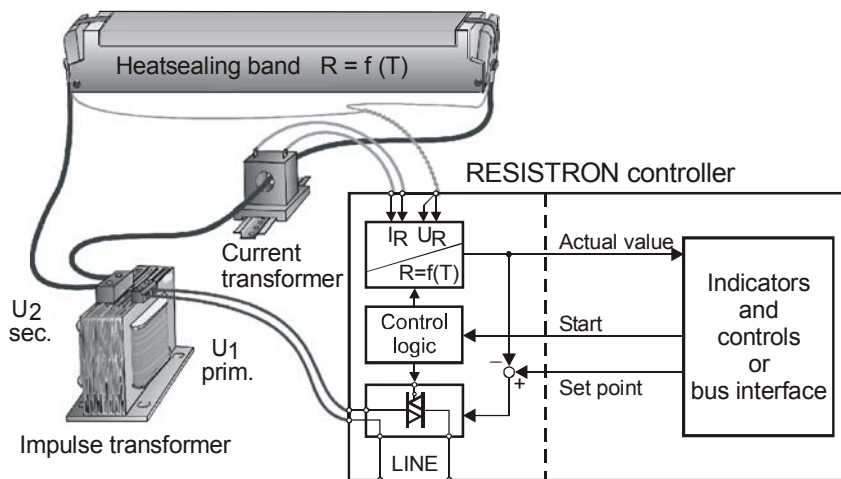

4 Description of the controller

The microprocessor technology endows the RESISTRON temperature controller RES-406 with previously unattainable capabilities:

- Very simple operation thanks to AUTOCAL, the automatic zero calibration function.
- Good dynamic response of the control system thanks to AUTOTUNE, which adapts automatically to the controlled system.
- High precision thanks to further improved control accuracy and linearization of the heatsealing band characteristic.
- High flexibility: The AUTORANGE function (as of February 2006) covers a secondary voltage range from 0.4V to 120V and a current range from 30A to 500A.
- Automatic adjustment to the line frequency in the range from 47Hz to 63Hz.
- Increased protection against dangerous conditions, such as overheating of the heatsealing band.

The RESISTRON temperature controller RES-406 is equipped with a PROFIBUS-DP interface. This

interface can be used to control all the controller functions and interrogate controller information.

The ACTUAL temperature of the heatsealing band is supplied to the PROFIBUS interface and to an analog 0 to 10V DC output. The real heatsealing band temperature can thus be displayed on an external temperature meter (e.g. ATR-x).

The RES-406 features an integrated fault diagnosis function, which tests both the external system (heatsealing band, wiring etc.) and the internal electronics and outputs a selective error message in case of a fault.

To increase operational safety and interference immunity, all PROFIBUS signals are electrically isolated from the controller and the heating circuit.

Either coding switches on the temperature controller itself or the PROFIBUS interface can be used to adapt to different heatsealing band alloys (Alloy-20, NOREX etc.) and set to the required temperature range (0...300°C, 0...500°C etc.).



The compact design of the RESISTRON temperature controller RES-406 and the plug-in connections make this controller easy to install.





5 Accessories and modifications

A wide range of compatible accessories and peripheral devices are available for the RESISTRON temperature controller RES-406. They allow it to be optimally adapted to your specific heatsealing application and to your plant's design and operating philosophy.

5.1 Accessories

The products described below are only a few of the wide range of accessories available for RESISTRON temperature controllers (↪ "Accessories" leaflet).

	<p>Analog temperature meter ATR-x For front panel mounting or mounting on a top hat rail (DIN TS35 rail). Analog indication of the ACTUAL temperature of the heatsealing band in °C. The meter damping of the unit is optimized for the abrupt temperature changes that occur in impulse mode.</p>
	<p>Digital temperature meter DTR-x For front panel mounting or mounting on a top hat rail (DIN TS35 rail). Digital indication of the ACTUAL temperature of the heatsealing band in °C, with HOLD function.</p>
	<p>Line filter LF-xx480 Essential in order to ensure CE conformity. Optimized for the RESISTRON temperature controller.</p>

	<p>Impulse transformer ITR-x Designed according to VDE 0570/EN 61558 with a one section bobbin. Optimized for impulse operation with RESISTRON temperature controllers. Specified according to the heatsealing application (↪ ROPEX Application Report).</p>
	<p>Communication interface CI-USB-1 Interface for connecting a RESISTRON temperature controller with diagnostic interface (DIAG) to the PC (USB port). Associated PC visualization software for displaying setting and configuration data, and for recording SET and ACTUAL temperatures in real time.</p>
	<p>Booster B-xxx400 External switching amplifier, necessary for high primary currents (continuous current > 5A, pulsed current > 25A).</p>
	<p>Monitoring current transformer For detecting frame short-circuits on the heatsealing band. Used as an alternative to the standard PEX-W2/-W3 current transformer.</p>
	<p>Measurement cable UML-1 twisted measurement cable for the U_R-voltage measurement. Trailing cable, halogene und silicone free.</p>

5.2 Modifications (MODs)

Owing to its universal design, the RESISTRON temperature controller RES-406 is suitable for a very wide range of heatsealing applications. One modification (MOD) is available for the RESISTRON temperature controller RES-406 for implementing special applications.

MOD 01

Amplifier for low secondary voltages ($U_R = 0.25 \dots 16VAC$). This modification is necessary, for example, for very short or low-resistance heatsealing bands.

6 Technical data

Type of construction	Housing for installation in the electrical cabinet Snaps onto a standard top hat rail (DIN TS35 rail, 35 mm) acc. to DIN EN 50022 Dimensions: 90 x 75mm; height: 135mm (incl. terminals)
Line voltage	<p><u>All controllers manufactured as of February 2006:</u> 115VAC version: 110VAC -15%...120VAC +10% (equivalent to 94...132VAC) 230VAC version: 220VAC -15%...240VAC +10% (equivalent to 187...264VAC) 400VAC version: 380VAC -15%...415VAC +10% (equivalent to 323...456VAC)</p> <p><u>All controllers manufactured as of January 2004 up to January 2006:</u> 115VAC version: 115VAC -15%...120VAC +10% (equivalent to 98...132VAC) 230VAC version: 230VAC -15%...240VAC +10% (equivalent to 196...264VAC) 400VAC version: 400VAC -15%...415VAC +10% (equivalent to 340...456VAC)</p> <p><u>All controllers manufactured up to December 2003:</u> 115VAC, 230VAC or 400VAC, tolerance: +10% / -15%</p> <p>depending on version selected (↪ section 13 "How to order" on page 49)</p>
Line frequency	47...63Hz, automatic adjustment to frequencies in this range
24VDC-Supply voltage Terminals 5+7 or PROFIBUS plug, pins 2+7	24VDC, I _{max} = 100mA Tolerance: +10 / -10% The 24VDC-Supply voltage can be fed either via terminals 5 and 7 or via the PROFIBUS plug at pins 2 and 7.
PROFIBUS-DP interface	Baud rates: 9.6kbaud; 19.2kbaud; 45.45kbaud; 93.75kbaud; 187.5kbaud; 500kbaud; 1.5Mbaud; 3Mbaud; 6Mbaud; 12Mbaud Plug acc. to IEC 61158
Heatsealing band type and temperature range	<p><u>All controllers manufactured as of February 2006:</u> The temperature range and temperature coefficient settings can also be specified by means of the ROPEX visualization software (↪ section 10.11 "Diagnostic interface/visualization software (as of February 2006)" on page 39) in addition to the rotary coding switch (see below): Temperature range: 200°C, 300°C, 400°C or 500°C Temperature coefficient: 400...4000ppm (variable setting range)</p> <p><u>All controllers manufactured as of start of production:</u> Five different ranges can be set with the rotary coding switch or via the PROFIBUS interface: Temperature coefficient 1100ppm, 0...300°C (e.g. Alloy-20) Temperature coefficient 780ppm, 0...300°C (e.g. Alloy L) Temperature coefficient 1100ppm, 0...500°C (e.g. Alloy-20) Temperature coefficient 780ppm, 0...500°C (e.g. Alloy L) Temperature coefficient 3500ppm, 0...300°C (e.g. NOREX)</p> <p>The settings for a temperature coefficient of 780ppm are only available on controllers manufactured as of October 2003.</p>

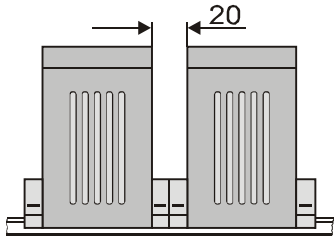
Analog output (actual value) Terminals 17+18	0...10V DC, I _{max} = 5mA Equivalent to 0...300°C or 0...500°C Accuracy: ±1% add. 50mV
Alarm relay Terminals 12, 13, 14	U _{max} = 50V (DC/AC), I _{max} = 0.2A, changeover contact, potential-free
Maximum load (primary current of impulse transformer)	I _{max} = 5A (duty cycle = 100%) I _{max} = 25A (duty cycle = 20%)
Power dissipation	max. 20W
Ambient temperature	+5...+45°C
Degree of protection	IP20
Installation	<p>If several controllers are installed on one top hat rail (DIN TS35 rail), a clearance of at least 20mm should be allowed between them.</p>  <p>The moving clip required for fastening must be facing down for mounting on a horizontal top hat rail.</p> <p>End holders to mechanical fix the controller must be fitted at both ends for mounting on a vertical top hat rail.</p>
Weight	Approx. 0.7 kg (incl. connector plug-in parts)
Housing material	Plastic, polycarbonate, UL-90-V0
Connecting cables Type / cross-sections	Rigid or flexible; 0.2...2.5mm ² (AWG 24...12) Plug-in connectors <p>⚠ If ferrules are used, they must be crimped in accordance with DIN 46228 and IEC/EN 60947-1. This is essential for proper electrical contact in the terminals.</p>

7 Dimensions

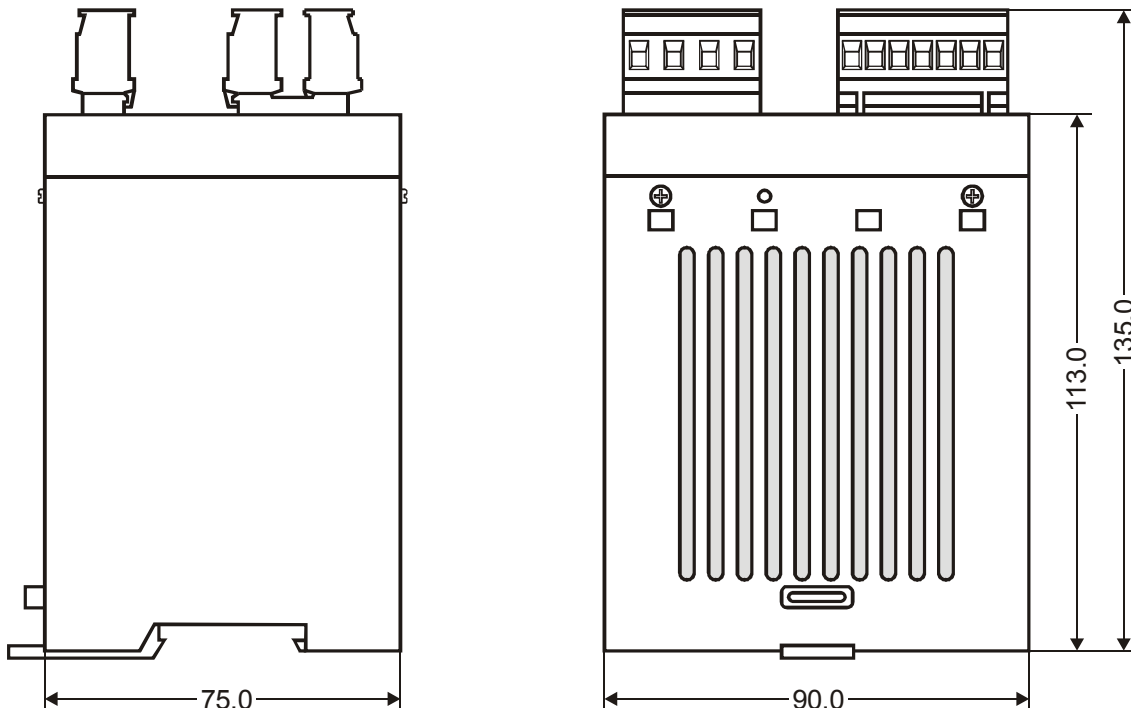

8 Installation

↳ See also section 1 "Safety and warning notes" on page 3.

⚠ Installation and startup may only be performed by technically trained, skilled persons who are familiar with the associated risks and warranty provisions.

8.1 Installation procedure

Proceed as follows to install the RESISTRON temperature controller RES-406:

1. Switch off the line voltage and verify that the circuit is de-energized.
2. The supply voltage specified on the nameplate of the RESISTRON temperature controller must be identical to the line voltage that is present in the plant or machine. The line frequency is automatically detected by the RESISTRON temperature controller in the range from

47Hz...63Hz.

3. Install the RESISTRON temperature controller in the electrical cabinet on a standard top hat rail (DIN TS35 rail, according to DIN EN 50022). If several controllers are installed on one top hat rail, the minimum clearance specified in section 6 "Technical data" on page 8 must be allowed between them.
4. Wire the system in accordance with the instructions in section 8.3 "Power supply" on page 12, section 8.6 "Wiring diagram (standard)" on page 14 and the ROPEX Application Report. The information provided in section 8.2 "Installation steps" on page 11 must also be heeded.
An overcurrent protective device (e.g. a fuse) must be fitted when the controller is installed. The minimum possible specification for this device must be entered in the ROPEX Application Report based on the calculated currents. If a larger overcurrent protective device is fitted, you must match the current carrying capacity of the other components accordingly (e.g. cables, impulse transformer etc.).

5. Connect the RESISTRON temperature controller to the PROFIBUS master using a cable according to IEC 61158.
6. Make sure that the wiring conforms to the relevant national and international installation regulations.

⚠ Check the tightness of all the system connections, including the terminals for the impulse transformer windings.

8.2 Installation steps

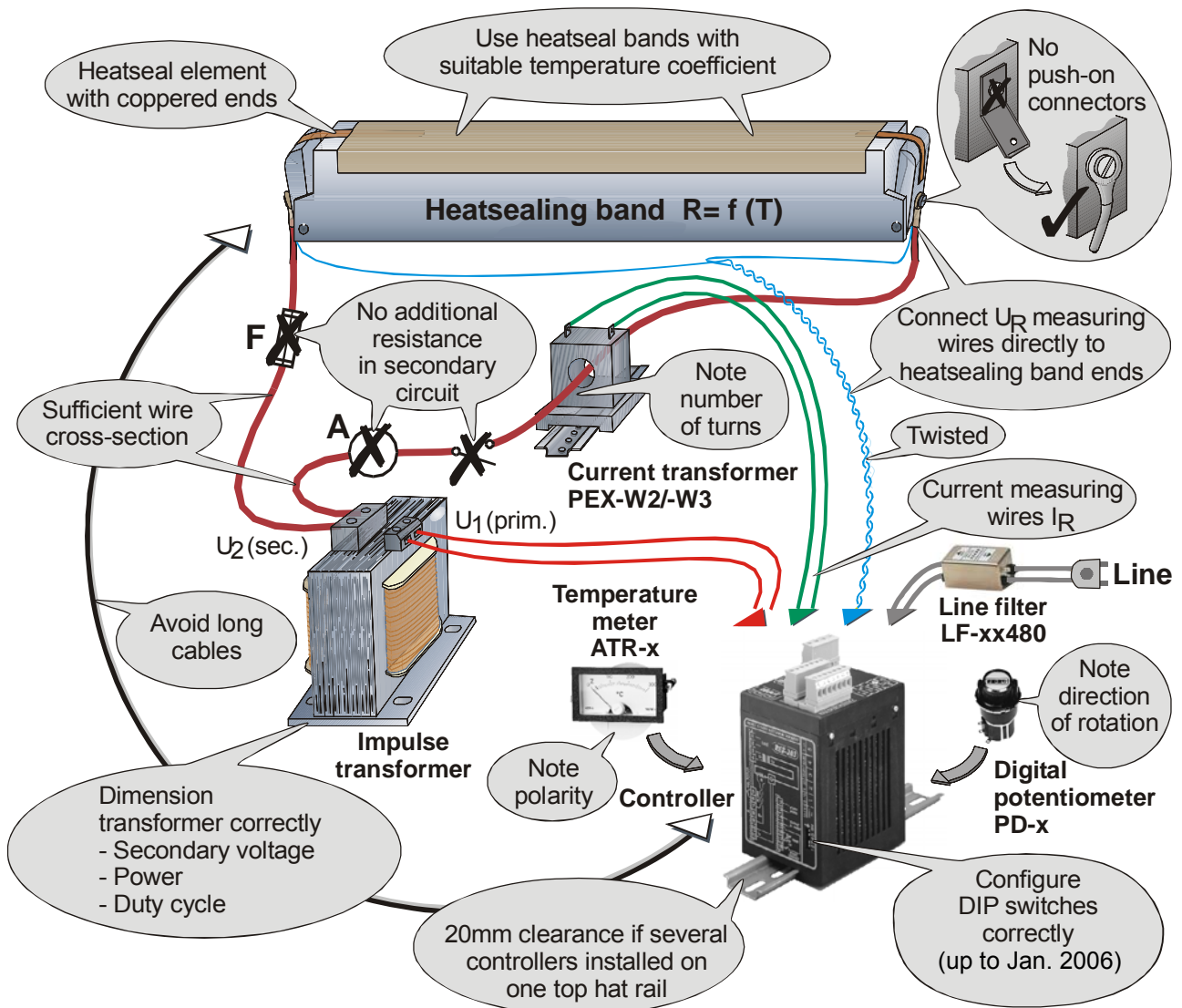

8.3 Power supply

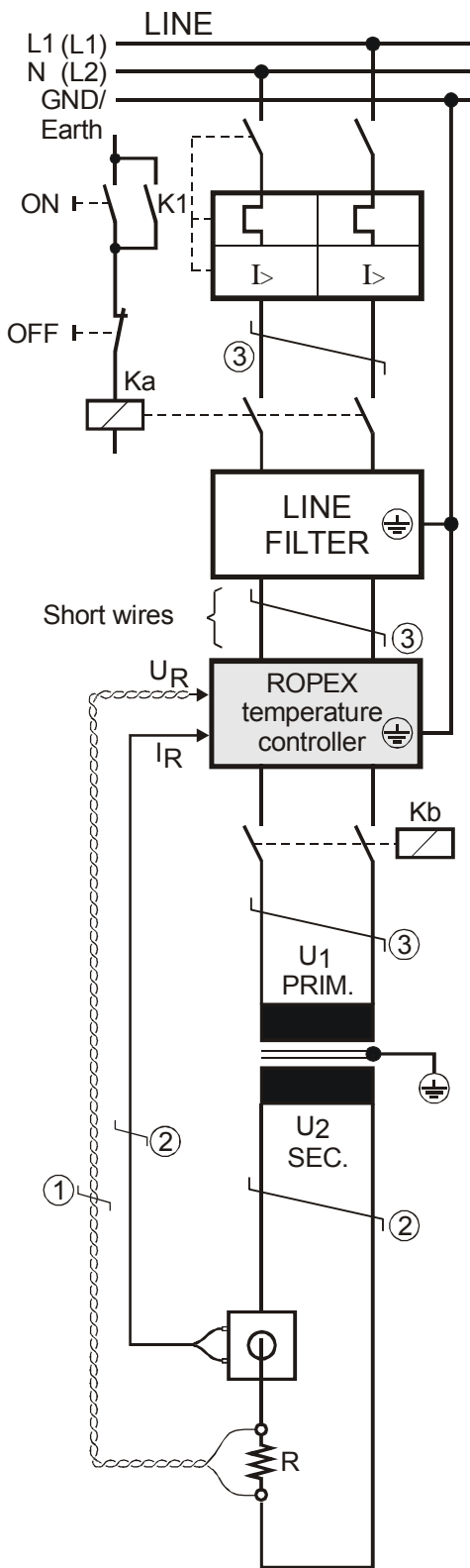

Line

115VAC, 230VAC, 400VAC
50/60Hz

Over-current protection

Double-pole circuit-breaker or fuses,
(☞ ROPEX Application Report)

⚠ Short-circuit protection only.
RESISTRON temperature controller not protected.

Relay Ka

For "HEAT ON - OFF" function (all-pole) or
"EMERGENCY STOP".

Line filter

The filter type and size must be determined according to
the load, the transformer and the machine wiring
(☞ ROPEX Application Report).

⚠ Do not run the filter supply wires (line side) parallel
to the filter output wires (load side).

RESISTRON temperature controller belonging to the
4xx Series.

Relay Kb

Load break (all-pole), e.g. in combination with the alarm
output of the temp. controller (ROPEX recommendation).

⚠ When using a series resistor RV-....-1 the relay Kb
shall be installed.

Impulse Transformer

Designed according to VDE 0570/EN 61558 (isolating
transformer with reinforced insulation). Connect core to
ground.

⚠ Use transformers with a one section bobbin. The
power, duty cycle and voltage values must be
determined individually according to the application
(☞ ROPEX Application Report and "Accessories" leaflet
for impulse transformers).

Wiring

The wire cross-sections depend on the application
(☞ ROPEX Application Report).

Guide values:

Primary circuit: min. 1.5mm², max. 2.5mm²

Secondary circuit: min. 4.0mm², max. 25mm²

- ① These wires must always be twisted (>20turns/meter).
- ② These wires must be twisted (>20turns/meter)
if several control loops are laid together ("crosstalk").
- ③ Twisting (>20turns/meter) is recommended to
improve EMC.

8.4 Line filter

To comply with EMC directives – corresponding to EN 50081-1 and EN 50082-2 – RESISTRON control loops must be operated with line filters. These filters damp the reaction of the phase-angle control on the line and protect the controller against line disturbances.

! The use of a suitable line filter is part of the standards conformity and a prerequisite of the CE mark.

installed and wired correctly, they guarantee compliance with the EMC limit values. You can find the exact specification of the line filter in the ROPEX Application Report calculated for your particular heatsealing application. For more technical information: ↪ "Line filter" documentation.

! It is permissible to supply several RESISTRON control loops with a single line filter, providing the total current does not exceed the maximum current of the filter.

ROPEX line filters are specially optimized for use in RESISTRON control loops. Providing that they are

The wiring instructions contained in section 8.3 "Power supply" on page 12 must be observed.

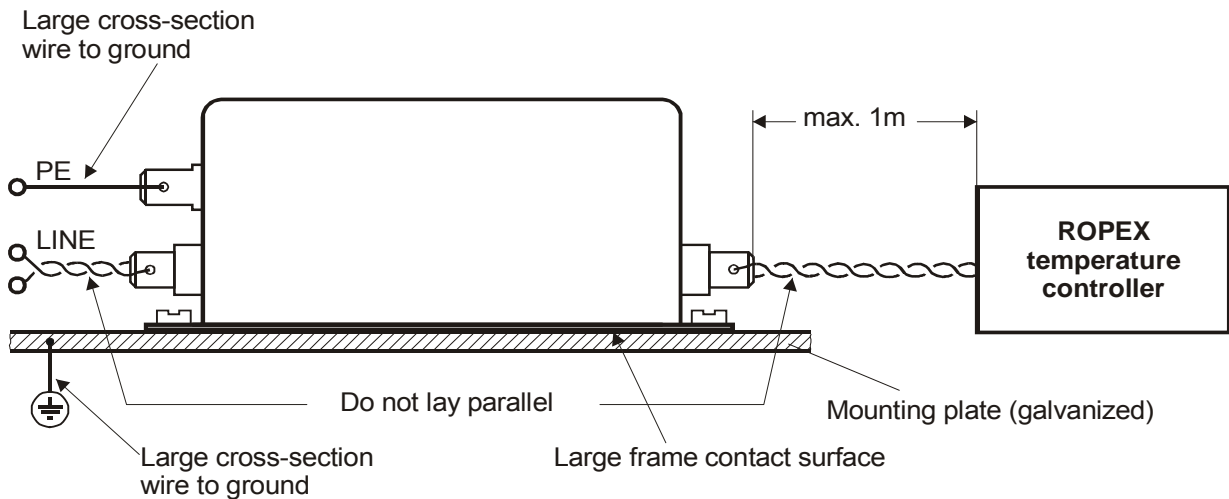

8.5 Current transformer PEX-W3

The PEX-W3 current transformer supplied with the RESISTRON temperature controller is an integral part

of the control system. The current transformer may only be operated if it is connected to the temperature controller correctly (↪ section 8.3 "Power supply" on page 12).

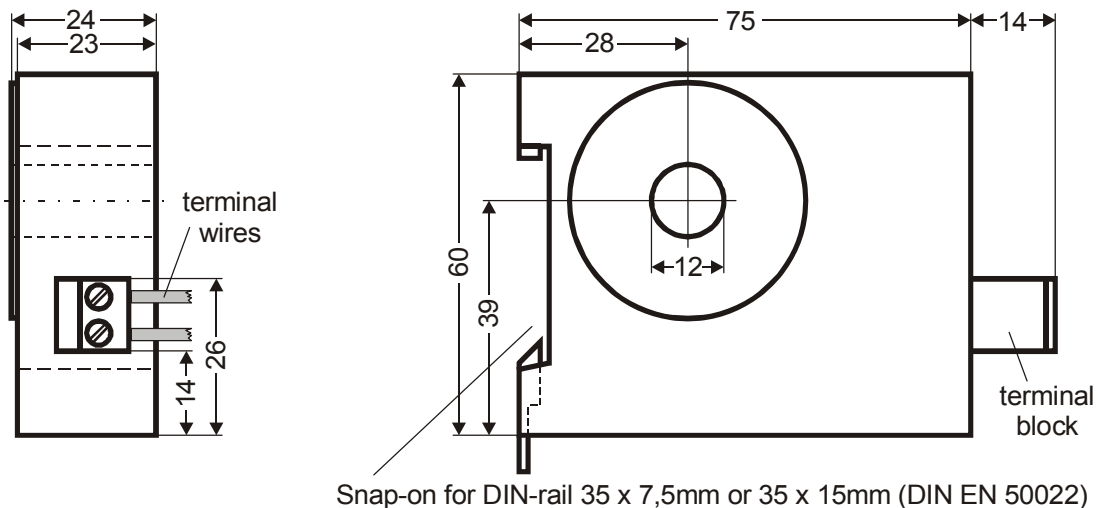

8.6 Wiring diagram (standard)

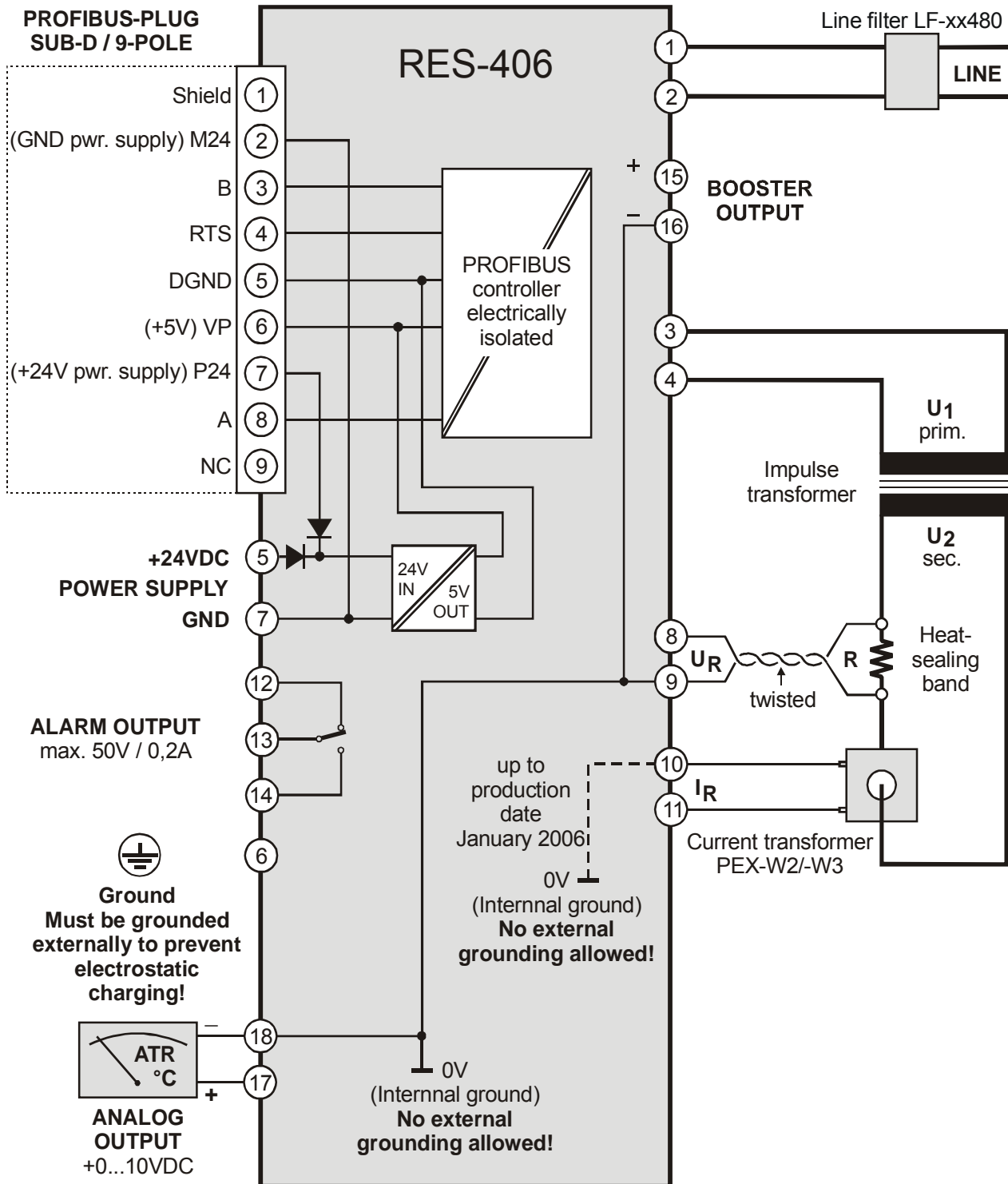

8.7 Wiring diagram with booster connection

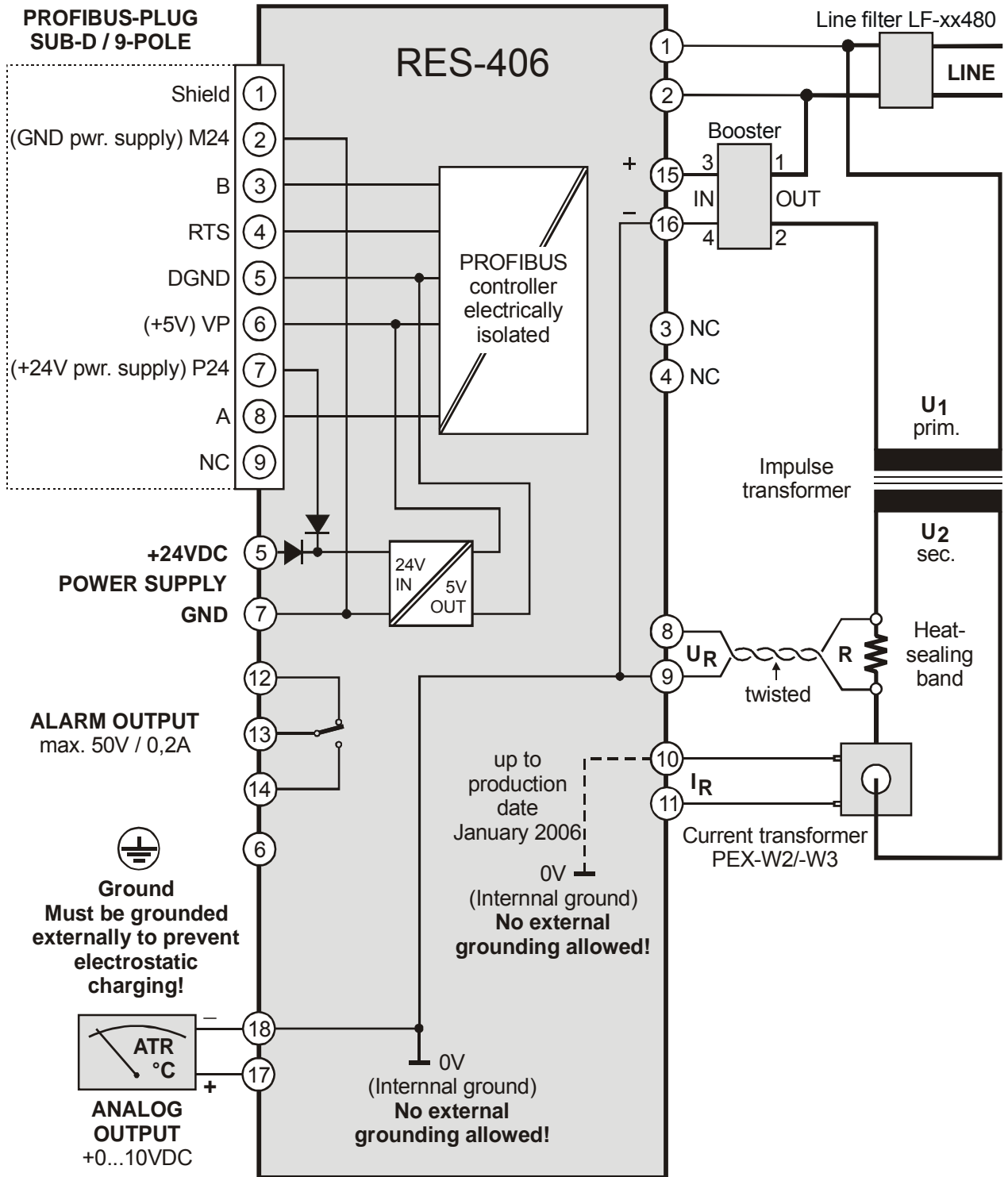

9 Startup and operation

9.1 View of the controller

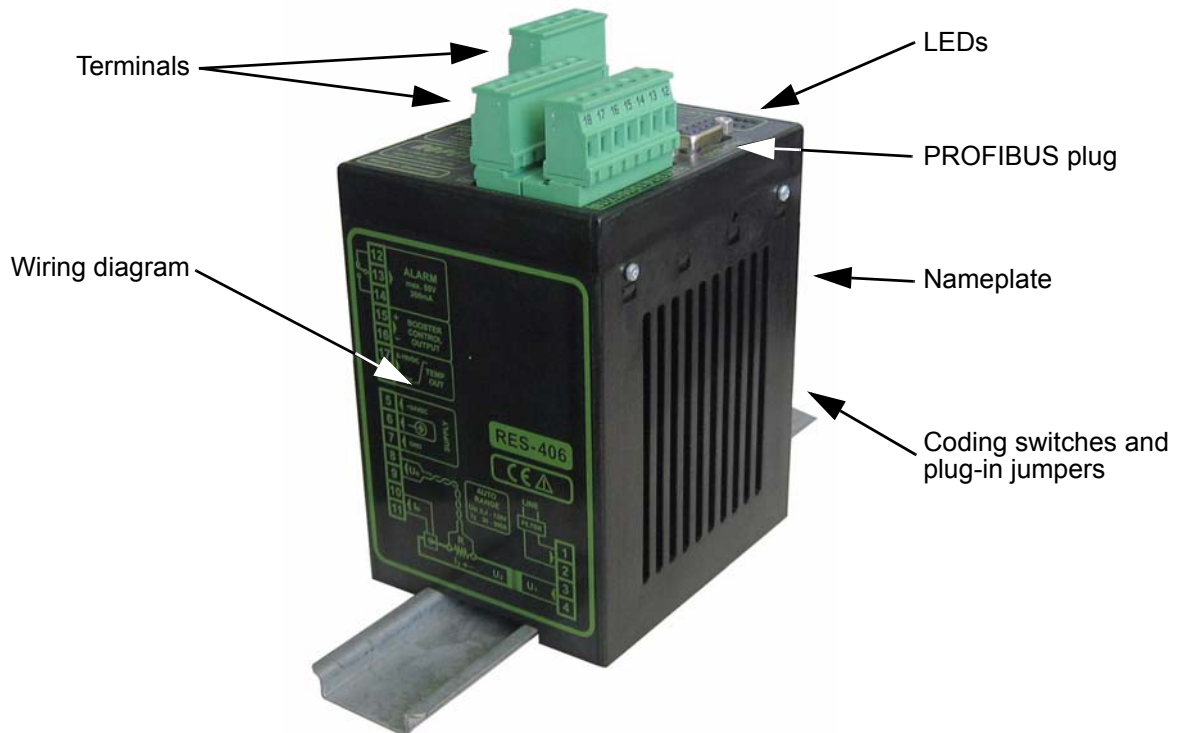

9.2 Controller configuration

! The controller must be switched off in order to configure the coding switches and plug-in jumpers.

9.2.1 Configuration of the DIP switches for secondary voltage and current

Automatic configuration (AUTORANGE) (as of February 2006)

The secondary voltage and current ranges are automatically configured by the automatic calibration function (AUTOCAL). The voltage is configured in the range from 0.4VAC to 120VAC and the current in the

range from 30A to 500A. If the voltage and/or the current is outside the permissible range, a detailed error message appears on the controller (see section 10.16 "Error messages" on page 41).

Configuration with coding switches (up to January 2006)

Set the DIP switches for matching the secondary voltage U_2 and the secondary current I_2 to the correct position for your application.

! You can find the exact configuration of the DIP switches in the ROPEX Application Report calculated for your particular application.

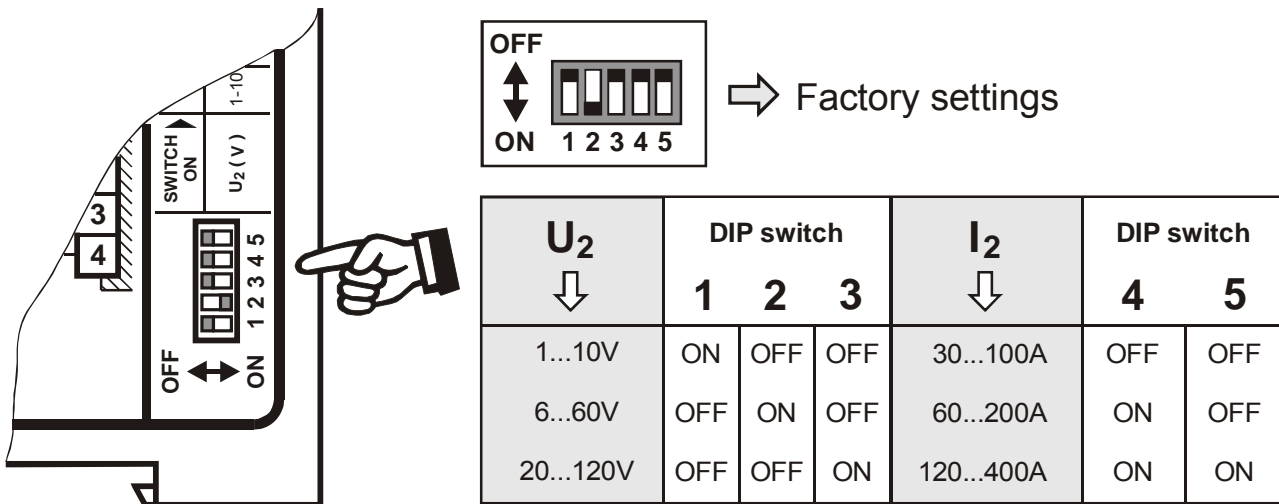

If the secondary current I₂ is less than 30A, the PEX-W2 or PEX-W3 current transformer must have two turns (↪ ROPEX Application Report).



9.2.2 Configuration of the rotary coding switch for the temperature range and alloy

Switch position	Temp. range	Temp. coefficient	Band alloy
0	300°C	1100ppm/K	e.g. Alloy-20
1	300°C	780ppm/K	e.g. Alloy L
4	500°C	1100ppm/K	e.g. Alloy-20
5	500°C	780ppm/K	e.g. Alloy L
8	300°C	3500ppm/K	e.g. NOREX
9	PC-CONFIGURATION		

0 = Factory settings

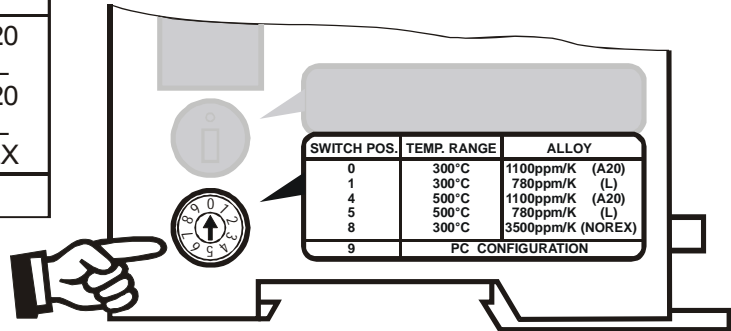

! The settings for a temperature coefficient of 780ppm (switch position 1 and 5) are only available on controllers manufactured as of October 2003.

! The setting of the rotary coding switch for the temperature range and alloy can be overwritten with the parameter data (↪ section 10.7 "Parameter data" on page 30).

If the switch is set to "9" (as of February 2006), more temperature ranges and alloys can be selected by means of the ROPEX visualization software (↪ see section 10.11 "Diagnostic interface/visualization software (as of February 2006)" on page 39).

9.2.3 Configuration of the rotary coding switches for the station address

switches. A new setting does not take effect until the next time the controller is switched on.

The station address of the RES-406 in the PROFIBUS network can be set between 0 and 99 with these coding

Station address im PROFIBUS network between 0 and 99.

01 = Factory setting

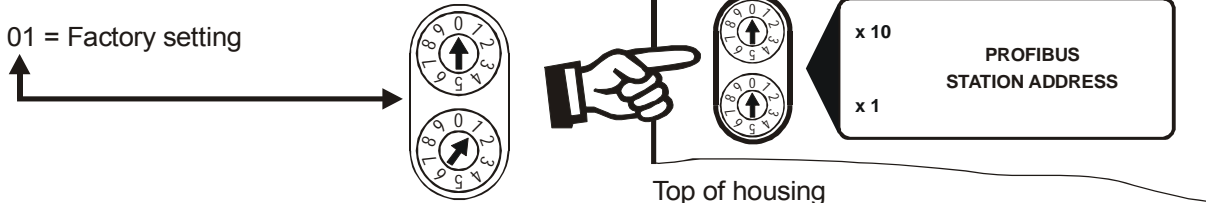

Top of housing

9.2.4 Configuration of the alarm relay

Alarm relay de-energized by alarm/PC-CONFIGURATION.

Alarm relay energized by alarm. (factory setting)

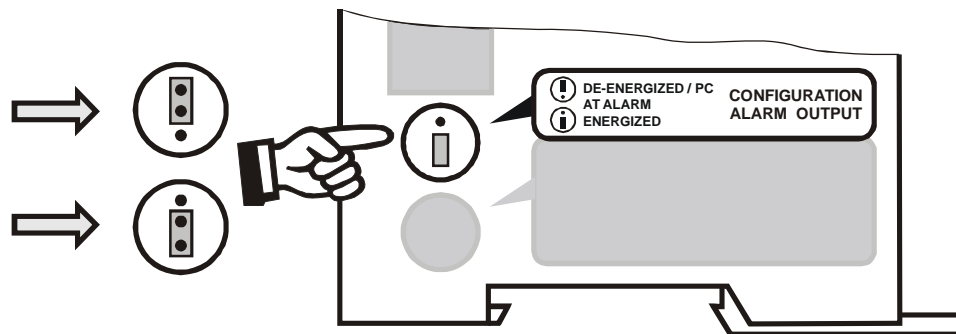

! If the jumper is not inserted, the alarm relay is permanently energized when using a controller up to production date January 2006. The other functions of the controller (e.g. heating, AUTOCAL etc.) are not impaired by this. If the plug-jumper is not inserted when using a controller as of production date February 2006 - or if it is incorrectly inserted - an error message appears when the controller is switched on (see section 10.16 "Error messages" on page 41).

If the "Alarm relay deenergized by alarm/PC CONFIGURATION" position is selected (as of February 2006), the behavior of the alarm output can be configured in more detail by means of the ROPEX visualization software (see section 10.11 "Diagnostic interface/visualization software (as of February 2006)" on page 39).

9.3 Replacing and "burning in" the heatsealing band

9.3.1 "Burning in" the heatsealing band

The heatsealing band is a key component in the control loop, since it is both a heating element and a sensor. The geometry of the heatsealing band is too complex to be discussed at length here. We shall therefore only refer to a few of the most important physical and electrical properties:

The measuring principle applied for this system necessitates a heatsealing band alloy with a suitable temperature coefficient TCR. Too low a TCR leads to oscillation or uncontrolled heating.

When heatsealing bands with a higher TCR are used, the controller must be calibrated for this.

The first time the heatsealing band is heated to approximately 200...250°C, the standard alloy undergoes a once-only resistance change (burn-in effect). The cold resistance of the heatsealing band is reduced by approximately 2...3%. However, this at first glance slight resistance change results in a zero point error of 20...30°C. The zero point must therefore be

corrected after a few heating cycles, i.e. the AUTOCAL function must be repeated.

The burn-in effect described here does not occur if the heatsealing band has already been thermally pretreated by the manufacturer.

 An overheated or burned-out heatsealing band must no longer be used because the TCR has been altered irreversibly.

One very important design feature is the copper or silver-plating of the heatsealing band ends. Cold ends allow the temperature to be controlled accurately and increase the life of the teflon coating and the heatsealing band.

9.3.2 Replacing the heatsealing band

All power supply leads must be disconnected from the RESISTRON temperature controller in order to replace the heatsealing band.

 The heatsealing band must be replaced in accordance with the instructions provided by the manufacturer.

Each time the heatsealing band is replaced, the zero point must be calibrated with the AUTOCAL function while the band is still cold, in order to compensate production-related resistance tolerances. The burn-in procedure described above should be performed for all new heatsealing bands.

9.4 Startup procedure

Please also refer to section 1 "Safety and warning notes" on page 3 and section 2 "Application" on page 4.

 Installation and startup may only be performed by technically trained, skilled persons who are familiar with the associated risks and warranty provisions.

9.4.1 Initial startup

Prerequisites: The controller must be correctly installed and connected (↪ section 8 "Installation" on page 10).

Proceed as follows to start up the controller for the first time:

1. Switch off the line voltage and verify that all circuits are de-energized.
2. The supply voltage specified on the nameplate of the controller must be identical to the line voltage that is present in the plant or machine. The line frequency is automatically detected by the temperature controller in the range from 47...63Hz.
3. In the case of controllers manufactured up to January 2006, the settings of the DIP switches on the controller are indicated in the ROPEX Application Report and depend on the heatsealing band that is used.
The settings of the coding switches on the controller depend on the required station address in the PROFIBUS network (↪ section 9.2 "Controller configuration" on page 16).
4. Link the device master file into the PROFIBUS master (↪ section 10.3), select the required communication module ("compact" or "extended" protocol) and start the communication.
5. Make sure that the "ST" bit is not set.
6. Switch on the line voltage and the 24VDC auxiliary supply (the order is arbitrary).
7. When the voltage is switched on, the yellow "AUTOCAL" LED lights up for approximately 0.3seconds to indicate that the controller is being powered up correctly. This LED blinks slowly (1Hz) as long as no PROFIBUS communication is active. It does not go out again until it detects an active communication.

 All controllers manufactured as of February 2006: If the red "ALARM" LED lights up for 0.3s in addition to the yellow "AUTOCAL" LED when the voltage is switched on, the configuration of this controller has been changed in the visualization software (↪ section 10.11 "Diagnostic interface/ visualization software (as of February 2006)" on page 39). In order to avoid malfunctions, please check the controller configuration before continuing the startup procedure.

8. The green "DATA EXCHANGE" LED lights up to indicate an active PROFIBUS communication.

9. One of the following states then appears:

Up to production date January 2006:

"ALARM" LED	"OUTPUT" LED	ACTION
OFF	Short pulses every 1.2s	Go to 10
BLINKS fast (4Hz)	OFF	Go to 10
Lit continuously	OFF	Fault diagnosis (↪ section 10.16)

As of production date February 2006:

"ALARM" LED	"OUTPUT" LED	ACTION
OFF	Short pulses every 1.2s	Go to 10
BLINKS fast (4Hz)	OFF	Go to 10
Lit continuously	OFF	<u>Fault no. 901:</u> (Fault group: 7): Supply voltage/ Sync-Signal missing (↪ section. 10.2) <u>Otherwise:</u> Fault diagnosis (↪ section. 10.16)

10. Activate the AUTOCAL function while the heatsealing band is still cold by setting the "AC" bit (AUTOCAL) in the PROFIBUS protocol (↪ section 10.4 "PROFIBUS protocol" on page 24). The yellow "AUTOCAL" LED lights up for the duration of the calibration process (approx. 10...15s). The "AA" bit (AUTOCAL active) is set in addition and a voltage of app. 0V appears at the actual value output (terminals 17+18). If an ATR-x is connected, it indicates 0...3°C.

When the zero point has been calibrated, the "AUTOCAL" LED goes out and a voltage of 0.66VDC (300°C range) or 0.4VDC (500°C range)

appears at the actual value output instead. If an ATR-x is connected, it must be set to "Z".

If the zero point has not been calibrated successfully, the "AL" bit (alarm active) is set and the red "ALARM" LED blinks slowly (1Hz). In this case the controller configuration is incorrect (↪ section 9.2 "Controller configuration" on page 16 and ROPEX Application Report). Repeat the calibration after the controller has been configured correctly.

11. When the zero point has been calibrated successfully, specify a defined temperature by means of the PROFIBUS protocol (set point) and set the "ST" bit. The "RA" bit (controller active) is then activated and the "HEAT" LED lights up. The heating and control process can be observed at the actual value output:

The controller is functioning correctly if the temperature (which corresponds to the signal change at the analog output or the actual value in the PROFIBUS protocol) has a harmonious motion, in other words it must not jump abruptly, fluctuate or deviate temporarily in the wrong direction. This kind of behavior would indicate that the U_R measuring wire have been wired incorrectly.

If an error code is displayed, please proceed as described in section 10.16 "Error messages" on page 41.

12. Burn in the heatsealing band (↪ section 9.3 "Replacing and "burning in" the heatsealing band" on page 18) and repeat the AUTOCAL function.

The controller is now ready

9.4.2 Restart after replacing the heatsealing band

To replace the heatsealing band, proceed as described in section 9.3 "Replacing and "burning in" the heatsealing band" on page 18.

 **Always use a heatsealing band with the correct alloy, dimensions and copper-plating in order to avoid malfunctions and overheating.**

Continue with section 9.4 steps 5 to 12.

10 Controller functions

See also section 8.6 "Wiring diagram (standard)" on page 14.

10.1 Indicators and controls

Manufactured as of February 2006

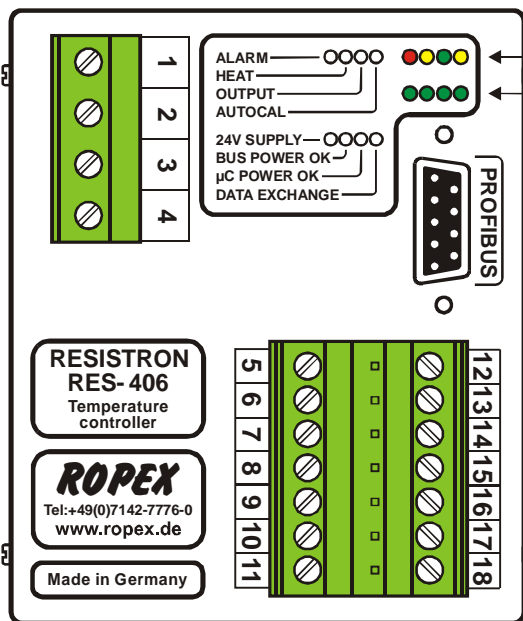

ALARM (red LED)	Lights up or blinks to indicate an alarm.
HEAT (yellow LED)	Lit during heating phase.
OUTPUT (green LED)	Indicates pulses in measurement mode. In control mode, luminous intensity is proportional to heating current.
AUTOCAL (yellow LED)	Remains lit for duration of AUTOCAL process.
24V SUPPLY (green LED)	Lit if external 24VDC power supply is present.
BUS PWR OK (green LED)	Lit if internal 5VDC power supply for Profibus interface is OK.
μC PWR OK (green LED)	Lit if internal 5VDC power supply for microcontroller is OK.
DATA EXC (green LED)	Remains lit while Profibus data is exchanged with master.

Manufactured up to January 2006

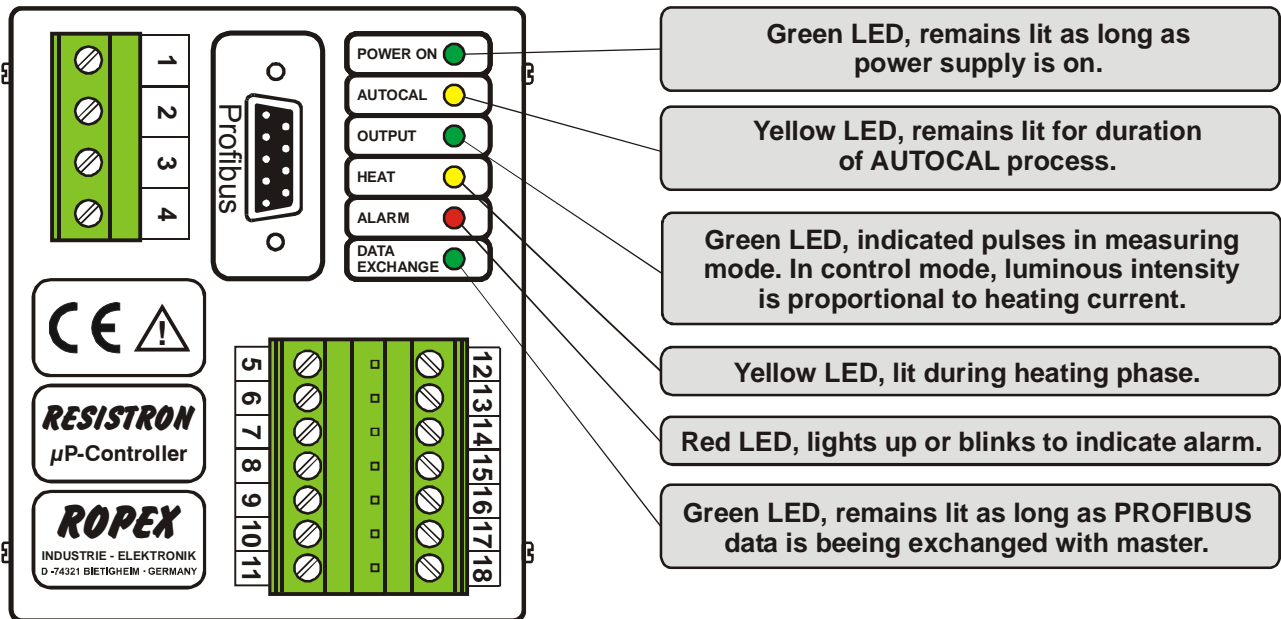

In addition to the functions shown in the diagram above, various controller operating states are indicated by the LEDs. These states are described in detail in the table below:

LED	Blinks slowly (1Hz)	Blinks fast (4Hz)	Lit continuously
AUTOCAL (yellow)	No PROFIBUS communication or RS-Bit is activated (Reset)	AUTOCAL requested, but function disabled	AUTOCAL executing
	LED blinks with a different frequency: Supply voltages incorrect (too low)		
HEAT (yellow)	—	START requested, but function disabled	START executing
OUTPUT (green)	In control mode the luminous intensity is proportional to the heating current.		
ALARM (red)	Configuration error, AUTOCAL not possible	Controller calibrated incorrectly, run AUTOCAL	Fault, ↪ section 10.16
DATA EXCHANGE (green)	—	—	Communication with PROFIBUS master active

! The following sections describe only controller-specific functions. For general information about PROFIBUS and the system configuration, please refer to the description of your PLC.

10.2 PROFIBUS communication „up to Jan. 2006“/“as of Feb. 2006“

On controllers manufactured up to January 2006, PROFIBUS communication is only assured if the 24VDC power supply (terminals 5+7 and PROFIBUS connector pins 7+2) and the line voltage are present. If the line voltage is switched off (e.g. for safety reasons in order to open a door), the PROFIBUS master indicates a bus fault because PROFIBUS communication is not possible on the RES-406.

This problem has been rectified on controllers manufactured as of February 2006. PROFIBUS communication is always possible on these controllers as long as the 24VDC power supply is present, i.e. switching off the line voltage no longer results in a bus fault.

! If the line voltage is not present however (e.g. if it is switched off in order to open a door), error code 901 (error group 7, no line voltage/sync signal) appears on controllers manufactured as of February 2006 and the alarm relay is switched. This error can be reset by switching on the line voltage again and activating the "RS" bit (↪ section 10.5.3 "Reset (RS)" on page 27).

The error code that appears if the line voltage is switched off can be easily processed, and switching of the alarm relay suppressed, in the PLC program.

! If controllers manufactured as of February 2006 are installed in an older machine (e.g. in order to carry out repairs), this new controller function can lead to unwanted error codes when the line voltage is switched off, depending on the PLC program.

Permanently disconnecting the 24VDC power supply (terminals 5+7 and PROFIBUS connector pins 7+2) results in the same behavior as on older controllers (manufactured up to January 2006), i.e. a bus fault in the PROFIBUS master.

10.3 Device master file (GSD)

Configuring tools for the PROFIBUS-DP master that must be configured interpret the contents of the slave device master files and use them to create a master parameter set for the PROFIBUS master, which is responsible for useful data communication. The *ROxy0613.GSD* file (xy: GSD Version; e.g. „15“ for version „v1.5“) of the RES-406 contains all the controller information needed for the configuration, e.g. the possible baud rates, parameter descriptions, error messages etc. The device master files and the associated display files (.DIB, for visualizing states) are supplied with the controller in German (.GSG) and English (.GSD or .GSE) on a diskette. They can also be requested by E-Mail (support@ropex.de) or they can be downloaded from our Homepage (www.ropex.de).

After the required device master file has been linked into the configuring tool, you must select one of the two communication modules ("compact" or "extended"). This determines which protocol will be used by the RES-406 to communicate with the PROFIBUS master.

! If you want to use all features of the controller make sure that the appropriate version of the device master file is used. Since production date 06.02 the required device master file version is printed on the housing of the temperature controller.



10.4 PROFIBUS protocol

The PROFIBUS protocol can be configured either as "compact" (16bits for input data and 16bits for output data) or as "extended" (2x16bits for input data and 2x16bits for output data). The protocol is determined at the configuring stage by selecting a module ("compact" or "extended"). The compact protocol is sufficient for efficient communication with the RES-406. The extended protocol separates the set point and the actual value of the RES-406 from the status information

and the control functions, to enable it to be decoded more easily by the PROFIBUS master.

 **Bits 0...7 form the low byte and bits 8...15 the high byte ("INTEL format").**

10.4.1 "Compact" protocol with 4-Bit error code

The 16-bit **input data** from the PROFIBUS master to the RES-406 contains the set point and the control functions and has the following structure:

	Control function				Spare			Set point / AC temperature									
Name:	RS	ST	AC	MP	0	0	0										
Bit no.:	15	14	13	12	11	10	9	8	7	6	5	4	3	2	1	0	

The 16-bit **output data** from the RES-406 to the PROFIBUS master contains the actual value or the

error code and the status information and has the following structure:

	Status information							Actual value (compact) if AL = 0							Error code if AL = 1		
Name:	AA	AG	AL	TE	TO	RA	VZ							A3	A2	A1	A0
Bit no.:	15	14	13	12	11	10	9	8	7	6	5	4	3	2	1	0	

10.4.2 "Compact" protocol with 10-Bit error code

 **The 10-Bit error codes are available on all controllers manufactured as of July 24,2006 and supplied with GSD Version v1.6. These error**

codes must be activated in the parameter data (↪ section 10.7.9 "Error code format" on page 32).

The 16-bit **input data** from the PROFIBUS master to the RES-406 contains the set point and the control functions and has the following structure:

	Control function				Spare			Set point / AC temperature									
Name:	RS	ST	AC	MP	0	0	0										
Bit no.:	15	14	13	12	11	10	9	8	7	6	5	4	3	2	1	0	

The 16-bit **output data** from the RES-406 to the PROFIBUS master contains the actual value or the

error code and the status information and has the following structure:

	Status information							Actual value (compact) if AL = 0							Error code if AL = 1		
Name:	AA	AG	AL	TE	TO	RA	VZ/A9	A8	A7	A6	A5	A4	A3	A2	A1	A0	
Bit no.:	15	14	13	12	11	10	9	8	7	6	5	4	3	2	1	0	

10.4.3 "Extended" protocol with 4-Bit error code

The extended protocol transfers 2x16bits. The 2x16-bit **input data** contains the set point in word ① and the control functions in word ②:

①	Spare							Set point / AC temperature									
Name:	0	0	0	0	0	0	0										
Bit no.:	15	14	13	12	11	10	9	8	7	6	5	4	3	2	1	0	

②	Spare												Control function			
Name:	0	0	0	0	0	0	0	0	0	0	0	0	MP	RS	ST	AC
Bit no.:	15	14	13	12	11	10	9	8	7	6	5	4	3	2	1	0

The 2x16-bit **output data** contains the actual value in word ① and the error code and status information in word ②:

①	Actual value (signed)															
Name:	VZ															
Bit no.:	15	14	13	12	11	10	9	8	7	6	5	4	3	2	1	0

②	Spare				Error code				Spare		Status information					
Name:	0	0	0	0	A3	A2	A1	A0	0	0	AA	AG	AL	TE	TO	RA
Bit no.:	15	14	13	12	11	10	9	8	7	6	5	4	3	2	1	0

10.4.4 "Extended" protocol with 10-Bit error code

codes must be activated in the parameter data (↪ section 10.7.9 "Error code format" on page 32).

 **The 10-Bit error codes are available on all controllers manufactured as of July 24,2006 and supplied with GSD Version v1.6. These error**

The extended protocol transfers 2x16bits. The 2x16-bit **input data** contains the set point in word ① and the control functions in word ②:

①	Spare							Set point / AC temperature								
Name:	0	0	0	0	0	0	0									
Bit no.:	15	14	13	12	11	10	9	8	7	6	5	4	3	2	1	0

②	Spare												Control function			
Name:	0	0	0	0	0	0	0	0	0	0	0	0	MP	RS	ST	AC
Bit no.:	15	14	13	12	11	10	9	8	7	6	5	4	3	2	1	0

The 2x16-bit **output data** contains the actual value in word ① and the error code and status information in word ②:

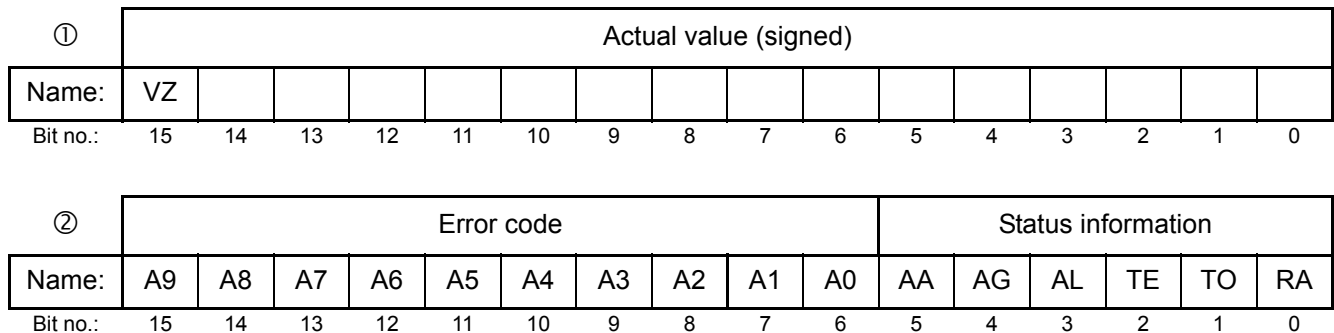

10.5 Input data

The term "input data" refers to the data that is transferred from the PROFIBUS master to the RES-406. It contains the set point and the control functions, such as START or AUTOCAL for the RES-406. These functions are explained in the following.

10.5.1 Automatic zero calibration "AUTOCAL" (AC)

Because of the automatic zero calibration (AUTOCAL) function, there is no need to adjust the zero point manually on the controller. This function matches the controller to the resistance of the system and calibrates it to the value which is predefined in the parameter data (section 10.7.4 "Variable calibration temperature" on page 31). If no parameter data is transferred by the PROFIBUS master, the default value is 20°C.

Some PROFIBUS masters do not allow the parameter data to be changed during operation. It is therefore not possible to adapt the calibration temperature to the prevailing ambient conditions in the machine.

As of GSD Version v1.6, the calibration temperature can be specified by means of the "Set point/AC temperature" input data whenever the zero point is calibrated, providing this setting is selected in the parameter data (↪ section 10.7.4 "Variable calibration temperature" on page 31). It can be specified in the 0...+40°C range. The value selected for the calibration temperature must be entered in the "Set point/AC temperature" input data when the "AUTOCAL" function is activated ("AC" bit = 1). This selected value must remain entered until the "AUTOCAL" function has finished.

If the specified temperature is too high (greater than 40°C) or if the selected value varies, an error message

appears (error codes 115 and 116; ↪ section 10.16 "Error messages" on page 41).

The AUTOCAL request ("AC" bit = 1) is executed by the controller providing the AUTOCAL function is not disabled.

The automatic calibration process takes about 10...15 seconds. The heatsealing band is not heated during this process. The yellow LED on the front panel lights up while the AUTOCAL function is active and the controller reports "AUTOCAL active" ("AA" bit = 1) in the output data. The actual value output (terminals 17+18) is 0...3°C (corresponds to app. 0 VDC).

If the temperature of the heatsealing band varies on controllers manufactured as of February 2006, the "AUTOCAL" function is executed a maximum of three times. If the function still cannot be terminated successfully, an error message appears (↪ section 10.16 "Error messages" on page 41).

 **You should always wait for the heatsealing band and the bar to cool down (to ambient temperature) before activating the AUTOCAL function.**

Reasons for disabled AUTOCAL function:

1. The AUTOCAL function cannot be activated until 10 seconds after the controller is switched on. During this time the controller reports "AUTOCAL disabled" ("AG" bit = 1) in the output data.
2. The AUTOCAL function is not activated if the heatsealing band is cooling down at a rate of more than 0.1K/sec. If the "AC" bit is activated, the function is executed automatically providing the cooling rate has fallen below the above-mentioned value.

3. If the "START" bit ("ST" bit = 1) is activated, the AUTOCAL function is not executed ("HEAT" LED lit).
4. If the "RESET" bit ("RS" bit = 1) is activated, the AUTOCAL function is not executed.
5. AUTOCAL cannot be activated if error codes 1...3, 5...7 (As of February 2006 also: 101...103, 201...203, 801, 9xx) occur at start-up. AUTOCAL cannot be activated with error codes 5...7 (As of February 2006 also: 201...203, 801, 9xx) if the controller has operated correctly, at least one time, after start-up (↪ section 10.16 "Error messages" on page 41).

! If the AUTOCAL function is disabled ("AG" bit = 1) and if you attempt to activate it ("AC" bit = 1) then the "AUTOCAL" LED blinks fast (4Hz).

10.5.2 Start (ST)

When the "START" bit is activated ("ST" bit = 1), the controller-internal set/actual comparison is enabled and the heatsealing band is heated up to the SET temperature. It remains at this temperature either until the "ST" bit is reset or until the actual heating time exceeds the preset heating time limit (↪ section 10.7.5 "Heating time limit" on page 32).

The "HEAT" LED on the front panel of the RES-406 lights up continuously for the duration of the heating phase.

A start request is not processed if the AUTOCAL function is active, the controller has reported an alarm, the set point is less than 20°C higher than the calibration temperature or the "RS" bit is set. In all these cases the "HEAT" LED blinks.

The heating process is terminated if the "ST" bit is reset or if a PROFIBUS fault occurs.

! The "ST" bit is only accepted if the AUTOCAL function is deactivated and there are no alarms.

The alarm relay is switched if the "ST" bit is activated while a warning message is indicating error codes 8...12 (as of February 2006 also: 104...106, 111...114, 211, 302 oder 303) (↪ section 10.16 "Error messages" on page 41). The heatsealing band is no longer heated up.

10.5.3 Reset (RS)

This bit resets the controller if the controller reports an alarm.

No AUTOCAL or START requests are accepted as long as the "RS" bit is set. From then on, only fault nos. 5 and 7 (As of February 2006: 201...203, 901, 913) are evaluated and output by the fault diagnosis function. The power section is not activated in this state and no measuring impulses are generated. Consequently, the actual value is no longer updated. The reset request is not processed until the "RS" bit is reset. The PROFIBUS communication is not interrupted by a controller reset. The controller simply requests the parameter data from the PROFIBUS master again.

As of production date February 2006, the controller actual value output changes to 0...3°C (i.e. approximately 0VDC) while the "RS" bit is being activated. This may be interpreted by the higher-level controller (e.g. a PLC) as feedback.

The "AUTOCAL" function is not aborted if the "RS" bit is activated while it is still executing.

! The controller performs an internal initialization run lasting approximately 500ms after the "RESET" signal is deactivated. The next heatsealing process cannot be started until it has finished.

! If a contactor Kb is used to deactivate the control loop (↪ section 8.3 "Power supply" on page 12), it must be energized again 50ms at the latest after the "RESET" signal is deactivated. If it is energized too late, an error message will be output by the controller.

10.5.4 Measurement pause (MP)

No more measuring impulses are generated by the controller as soon as the "MP" bit is set. From then on, only fault nos. 5 and 7 (As of February 2006: 201...203, 901, 913) are evaluated and output by the fault diagnosis function. In addition, the actual value is no longer updated. The last valid value before the bit was set is output. As soon as the bit is reset, new measuring impulses are generated, all error messages are evaluated and the actual value is updated again.

This bit is only active in measuring mode. "ST", "RS" and "AC" take priority. The bit is suitable for all applications in which the electrical connections of the heatsealing band need to be disconnected during normal operation without triggering an alarm (e.g. sliding rail contacts).

In contrast with the "RS" bit (RESET), the "MP" bit does not reset any error message when it is set. The controller is activated again as soon as the bit is reset, in other words there is no initialization phase.

! When the controller is started, it only evaluates the "MP" bit if the system test (including the functional test of the heating circuit) is successful. This can take several 100 ms.

! The "MP" bit is available on all controllers manufactured as of July 14, 2003 and supplied with GSD Version v1.3.

10.5.5 Set point

A set point of up to 300°C or 500°C is allowed, depending on the selected temperature range (↪ section 10.7.1 "Temperature range and alloy" on page 31). If you attempt to enter a higher set point, it is limited to 300°C or 500°C internally.

10.6 Output data

The term "output data" refers to the data that is transferred from the RES-406 to the PROFIBUS master. It contains the current actual value and all important information about the momentary status of the controller. If an alarm is signaled, the fault can be diagnosed accurately with the help of the error code.

10.6.1 AUTOCAL active (AA)

The "AA" bit indicates that the AUTOCAL function is currently executing.

10.6.2 AUTOCAL disabled (AG)

If the "AG" bit is set, the AUTOCAL function is temporarily disabled. This is the case if "START" is active or if the heatsealing band is still in the cooling-down phase.

10.6.3 Alarm active (AL)

If the "AL" bit is set, an alarm has been triggered but not yet reset. The error code provides information about the exact cause of the fault (↪ section 10.16 "Error messages" on page 41).

10.6.4 Temperature reached (TE)

The "TE" bit is set if the actual temperature exceeds 95% of the set temperature. As soon as the control

mode is exited ("ST" bit = 0) or an alarm is signaled ("AL" bit = 1), this status bit is reset again.

10.6.5 Temperature OK (TO)

The RES-406 checks whether the actual temperature is within a settable tolerance band ("OK" window) on either side of the set temperature. The lower ($\Delta\vartheta_{lower}$) and upper ($\Delta\vartheta_{upper}$) limits of the tolerance band can be changed independently of one another by means of the parameter data (↪ section 10.7 "Parameter data" on page 30). The following settings are possible:

1. „off“
The „TO“ bit is always deactivated.
2. „Active if Tact = Tset“
(Factory setting up to software revision 017 and as of software revision 103)
The „TO“ bit is activated if the actual value is inside the specified temperature tolerance band. If the actual temperature is outside the tolerance band the „TO“ bit is deactivated (see graph below).

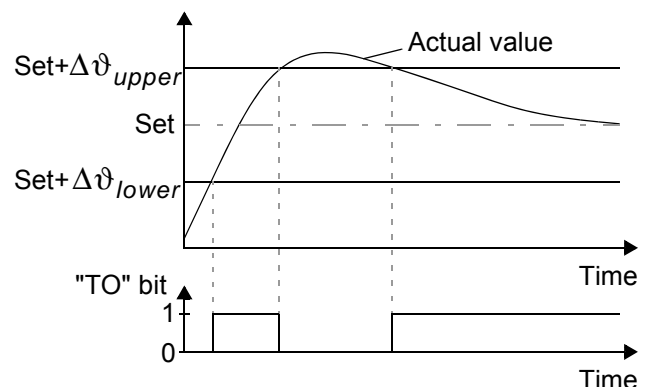

Unlike the "Temperature reached" status bit ("TE" bit), the actual temperature is evaluated independently of the control mode.

3. „Active if Tact = Tset, with latch function (as of software revision 100 available) (Factory setting for software revision 100...102)
A heatsealing cycle starts when the "ST" bit is set. The "TO" bit is set when the actual temperature reaches the temperature tolerance band for the first time during a heatsealing cycle. If the actual temperature leaves the tolerance band again - while the "ST" bit is still set - the "TO" bit is reset (refer to Fig. a.). If the actual temperature does not leave the tolerance band again - while the "ST" bit is still set - the "TO" bit is not reset until the start of the next heatsealing cycle (latch function, refer to Fig. b.).

The switching state of the "TO" bit can thus be queried after the "ST" bit has been reset and before the start of the next heatsealing cycle.

a.) Temperature not OK

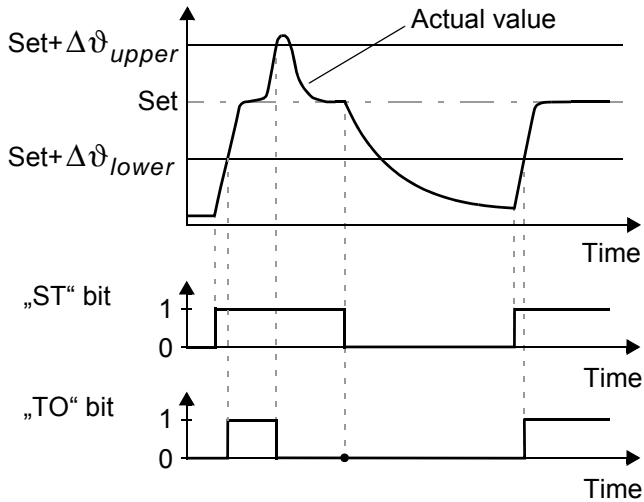

b.) Temperature OK

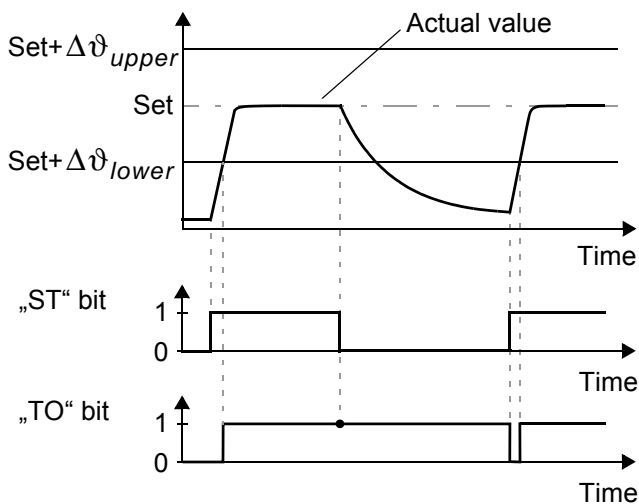

For controllers with software revision 100, 101 and 102 the configuration for the „TO“ bit can be set via the ROPEX visualization software. As of software revision 103 the configuration for the „TO“ bit is set in the PROFIBUS parameter data (or the DPV1 protocol extension). A configuration with the ROPEX visualization software is no more possible.

The limits of the tolerance band are adjustable to max. +99K on controllers manufactured as of

February 2006 and supplied with GSD Version v1.5 (On older controllers the limits are adjustable to max. +-20K).

10.6.6 Controller active (RA)

The RES-406 has processed the "START" request successfully and entered the control mode if the "RA" bit = 1.

10.6.7 Sign (VZ)

In the compact protocol, the sign bit indicates whether the actual value is positive or negative.

10.6.8 Actual value

If you are using the *compact* protocol, the actual value itself is always positive. The sign bit (VZ) then indicates whether the amount of the actual value is positive or negative. If an alarm is signaled, the actual value contains the error code.

If you are using the *extended* protocol, all 16 bits of the first word must be interpreted as a signed number (twos complement notation). During the calibration procedure or if an alarm is signaled, the actual value is 0. The error code is contained in separate bits.

10.6.9 Error codes

If a fault is signaled („AL“ bit = 1), the error code allows the exact cause to be determined. The "Error code format" parameter determines whether two or three-digit error codes are output. If two-digit error codes are specified, some faults are grouped together; three-digit error codes enable a fault to be identified more precisely.

In the compact protocol, the error code appears instead of the actual value in bits 0...3 (error code format = 4-bit) or 0...9 (error code format = 10-bit).

In the extended protocol, the error code appears in the second word at bit positions 8...11 (error code format = 4-bit) or 6...15 (error code format = 10-bit) (↪ section 10.16 "Error messages" on page 41).

! 10-bit error codes are available on all controllers manufactured as of July 24, 2006 and supplied with GSD Version v1.6. Older controllers only show 4-bit error codes.

In addition to the error codes, the PROFIBUS diagnostics function also sends error messages to the PROFIBUS master. The error messages corresponding to each error code are already stored in the device master file (GSD), so that they automatically appear in plain text on the PROFIBUS master whenever the device diagnosis for the RES-406 is interrogated there. The language in which the error messages are displayed depends on the selected device master file.

 **The PROFIBUS diagnostics function always transfers 4-bit error codes regardless of the setting of the "Error code format" parameter (see section 10.7.9 "Error code format" on page 32).**

10.7 Parameter data

The parameter data contains values for selecting the heatsealing band alloy, the temperature range, the upper and lower tolerance band limits for temperature monitoring, the calibration temperature and the optional heating time limit. It is transferred from the PROFIBUS master to the RES-406 each time the system is started up. If the parameter data is changed during operation, the RES-406 performs a reset. The PROFIBUS communication is not interrupted. The parameter data has the following structure:

No.	Function	Default value 1	Possible values
0...3	Reserved, set to 0	0	0
4	Temperature range / alloy	10	0, 1, 4, 5, 8, 10
5	Lower temperature OK threshold	10K	3...99K
6	Upper temperature OK threshold	10K	3...99K
7	Calibration temperature	20°C	-1, 0...40°C
8	Heating time limit (100ms units)	0	0...250 (0...25.0s)
9	Extended controller diagnostics	activated	deactivated, activated

No.	Function	Default value 1	Possible values
10	Measuring impulse duration (as of 14.07.03 and GSD Version v1.3)	17	17...30 (1.7...3.0ms)
11	Data format (as of 23.07.04 and GSD Version v1,4)	High/Low byte (Intel)	High/Low byte (Intel), Low/High byte (Motorola)
12	Error code format (as of 24.07.06 and GSD Version v1.6)	4 bit	4 bit, 10 bit
13/ 14	Temperature coefficient (as of Feb. 2006 and GSD Version v2.0)	1100 ppm	400...4000 ppm
15	Temperature range (as of Feb. 2006 and GSD Version v2.0)	300° C	200, 300, 400, 500 °C
16/ 17	Maximum temperature (as of Feb. 2006 and GSD Version v2.0)	300° C	200...500° C
18	Temperature diagnosis (as of Feb. 2006 and GSD Version v2.0)	deactivated	deactivated, activated
19	Temperature diagnosis delay time (100ms steps) (as of Feb. 2006 and GSD Version v2.0)	0s	0...99 (0...9.9s)
20/ 21	Heatup timeout (100ms steps) (as of Feb. 2006 and GSD Version v2.0)	0s	0...999 (0...99.9s)
22	AUTOCOMP (as of Feb. 2006 and GSD Version v2.0)	off	off, on, AUTO

No.	Function	De- fault value 1	Possible values
23	„TO“ bit (Temperatur OK) (as of Feb. 2006 and GSD Version v2.0)	active if Tact = Tset	off, active if Tact=Tset, active if Tact=Tset with latch
24	Hold mode (as of Feb. 2006 and GSD Version v2.0)	off	off, on, 2s

1. The default value is stored in the device master file and transferred from the PROFIBUS master to the RES-406 when the system is started up.

10.7.1 Temperature range and alloy

This parameter selects both the temperature range and the heatsealing band alloy. You can overwrite the setting of the rotary coding switch by changing the default value (10).

Value	Temperature range	Alloy
0	300°C	TCR = 1100ppm, e.g. Alloy-20
1	300°C	TCR = 780ppm, e.g. Alloy L
4	500°C	TCR = 1100ppm, e.g. Alloy-20
5	500°C	TCR = 780ppm, e.g. Alloy L
8	300°C	TCR = 3500ppm, e.g. NOREX
9	PC configuration (ROPEX visualization software)	PC configuration (ROPEX visualization software)
10	Rotary coding switch setting	Rotary coding switch setting

The settings for a temperature coefficient of 780ppm (values 1 and 5) are only available on controllers manufactured as of October 2003.

The setting „ROPEX visualization software“ (value 9) is available on controllers manufactured as of March 2007 and supplied with GSD Version v2.0.

You must always execute the AUTOCAL function after changing this parameter.

10.7.2 Lower temperature OK threshold

Lower threshold value for the "OK" window.
Refer section 10.6.5 "Temperature OK (TO)" on page 28 and section 10.7.11 "Temperature diagnosis (as of GSD Version v2.0)" on page 33).

10.7.3 Upper temperature OK threshold

Upper threshold value for the "OK" window.
Refer section 10.6.5 "Temperature OK (TO)" on page 28 and section 10.7.11 "Temperature diagnosis (as of GSD Version v2.0)" on page 33).

10.7.4 Variable calibration temperature

The calibration temperature is set to 20°C as default. You can change it to another value between 0°C and 40°C in order to adapt it to the temperature of the cooled-down heatsealing band.
Some PROFIBUS masters do not allow the parameter data to be changed during operation. It is therefore not possible to adapt the calibration temperature to the prevailing ambient conditions in the machine.
As of GSD Version v1.6, the calibration temperature can be activated for setting by means of the input data by selecting the value "-1" in the parameter data. The calibration temperature can then be specified via the "Set point/AC temperature input data" (↪ section 10.5.1 "Automatic zero calibration "AUTOCAL" (AC)" on page 26).

You do not need to execute the AUTOCAL function after changing the calibration temperature.

10.7.5 Heating time limit

The heating time limit provides additional protection against unwanted permanent heating. The controller automatically deactivates the heating impulse after the set heating time limit has elapsed if the start bit remains set for longer than the time specified by this limit. The start bit must be reset before the controller can be started up again.

The heating time limit is deactivated as default (0), but can be set to any value between 0s and 25.0s (0 and 250).

10.7.6 Extended controller diagnosis

The extended controller diagnosis uses the diagnostic function of the PROFIBUS protocol to display several faults of the RES-406 on the PROFIBUS master directly. For each fault there is a text message stored in the device master file so the error codes appear on the PROFIBUS master in plain text if the master has the capability to display text messages.

With the help of parameter No. 9 the extended controller diagnosis can be activated or deactivated. The default setting is "activated".

Although the extended controller diagnosis is deactivated, there is the fault diagnosis which is coded in the protocol.

 **This parameter is available on all controllers manufactured as of June 17, 2002 and supplied with GSD Version v1.2.**

DPV1 protocol extension (alarm model):

The extended device diagnostic functionality is not available with the DPV1 protocol extension and GSD Version v2.0 or higher (↪ section 10.8 "DPV1 protocol extension (as of GSD Version v2.0)" on page 35. The DPV1 alarm model (↪ section 10.8.2 "DPV1 alarm model" on page 35) must be used in this configuration instead. In this case, parameter no. 9 in the GSD file switches the so-called DPV1 diagnostic interrupt on and off.

If you want to keep the old extended device diagnostics (e.g. for reasons of software compatibility), you must use a GSD version previous to v2.0. The DPV1 functionality for the RES-406 is then automatically deactivated in the PROFIBUS master.

10.7.7 Measuring impulse duration

The length of the measuring impulses generated by the controller can be set with parameter no. 10. It may be necessary to set a measuring impulse that is longer than the default 1.7 ms for certain applications.

 **This parameter is available on all controllers manufactured as of July 14, 2003 and supplied with GSD Version v1.3.**

10.7.8 Data format

This parameter specifies the order of the bytes (Intel: "high/low byte", Motorola: "low/high byte") in the cyclic data for both input and output data (↪ section 10.4 "PROFIBUS protocol" on page 24). We recommend setting "low/high byte (Motorola)" for Siemens controllers.

 **This parameter is available on all controllers manufactured as of July 23, 2004 and supplied with GSD Version v1.4.**

10.7.9 Error code format

This parameter specifies the length of the error codes in the cyclic data. You can choose between a 4-bit and a 10-bit format (↪ section 10.4 "PROFIBUS protocol" on page 24). "4-bit" generates two-digit error codes in the range 1...3 and is the default setting. "10-bit" generates more detailed three-digit error codes (↪ section 10.16 "Error messages" on page 41).

 **This parameter is available on all controllers manufactured as of July 24, 2007 and supplied with GSD Version v1.6.**

10.7.10 Automatic phase angle compensation (AUTOCOMP) (as of GSD Version v2.0)

It may be necessary to compensate the phase angle displacement between the U_R and I_R measuring signals for special heatsealing applications (↪ ROPEX Application Report). The "AUTOCOMP" function is provided for this purpose. The following settings are possible:

1. „off“ (Factory setting)
The „AUTOCOMP“ function is switched off.

2. „on“

It is executed whenever the "AUTOCAL" function (↪ section 10.16 "Error messages" on page 41) is run twice in quick succession. The interval between the end of the first "AUTOCAL" function and the start of the second "AUTOCAL" must be shorter than 2.0s. The second "AUTOCAL" function only takes around 2.0s and incorporates the "AUTOCOMP" function.

If the interval between the two "AUTOCAL" functions is longer than 2.0s, "AUTOCAL" is executed normally again the second time.

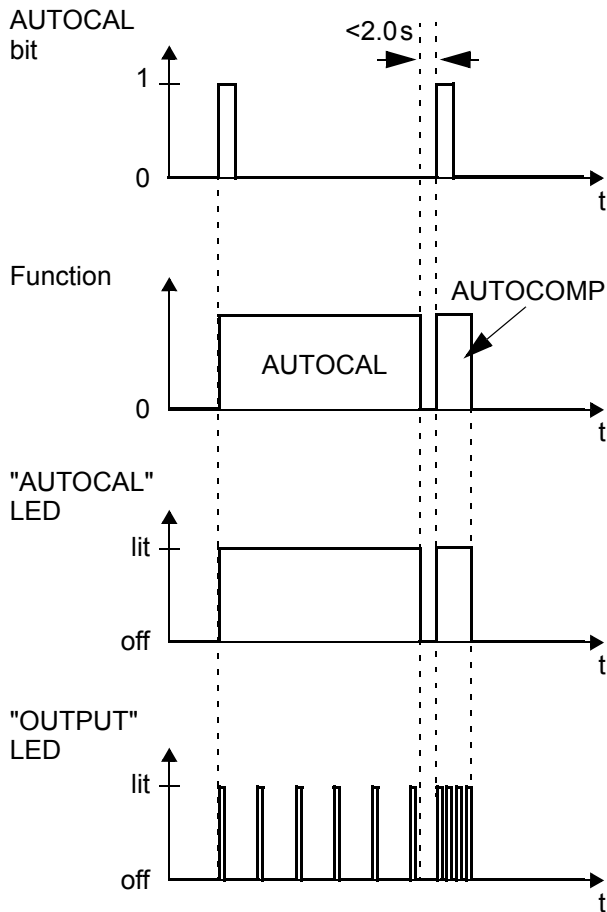

The "OUTPUT" LED blinks repeatedly when the "AUTOCOMP" function is executed and the actual value output (terminals 17+14) is set to 0...3°C (i.e. app. 0 VDC).

3. „AUTO“ (as of software revision 105)

With this setting the „AUTOCOMP“ function is activated automatically after the "AUTOCAL" function has been successfully executed.

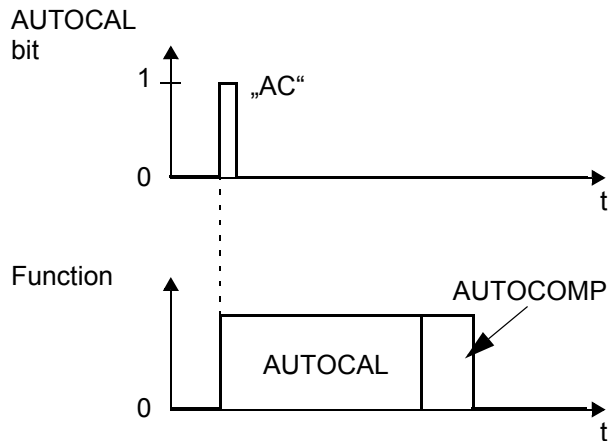

The "OUTPUT" LED blinks repeatedly when the "AUTOCOMP" function is executed and the actual value output (terminals 17+14) is set to 0...3°C (i.e. app. 0 VDC).

! The "AUTOCOMP" function must be activated by means of the PROFIBUS parameter data (↪ section 10.7 "Parameter data" on page 30) or the DPV1 protocol extension (↪ section 10.8 "DPV1 protocol extension (as of GSD Version v2.0)" on page 35). (default setting: AUTOCOMP off)

10.7.11 Temperature diagnosis (as of GSD Version v2.0)

An additional temperature diagnosis can be activated by means of the PROFIBUS parameter data or the DPV1 protocol extension.. The RES-406 checks whether the ACTUAL temperature is within a settable tolerance band ("OK" window) on either side of the SET temperature. The lower ($\Delta\vartheta_{lower}$) and upper ($\Delta\vartheta_{upper}$) tolerance band limits are the same like in the „Temperature OK“ function (↪ section 10.6.5 "Temperature OK (TO)" on page 28). The limits are configured in the factory to -10K and +10K.

If the actual temperature is inside the specified tolerance band when the "START" signal is activated, the temperature diagnosis is activated as well. If the ACTUAL temperature leaves the tolerance band, the corresponding error code (307 or 308) is indicated and the alarm relay is switched (↪ section 10.16 "Error messages" on page 41).

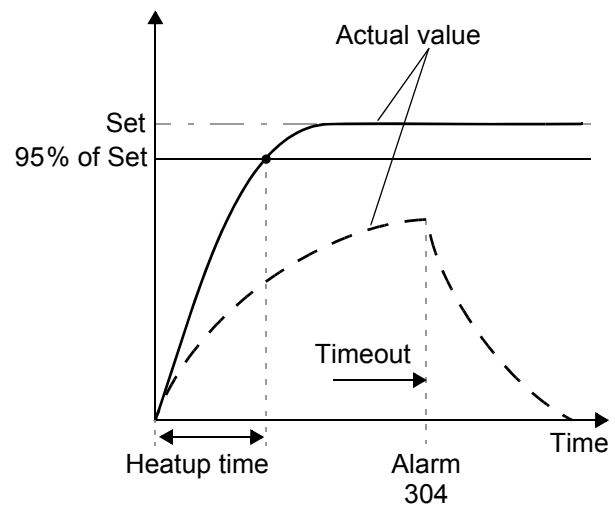
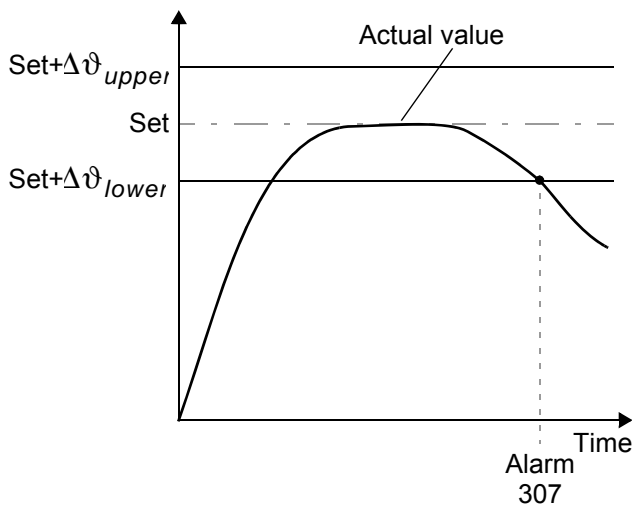

If the temperature diagnosis is not activated by the time the "START" bit is deactivated (i.e. if the ACTUAL temperature does not exceed the upper or lower tolerance band limit), the corresponding error code (309, 310) is indicated and the alarm relay is switched. An additional delay time (0...9.9s) can be set by means of the PROFIBUS parameter data or the DPV1 protocol extension. The first time the lower tolerance band limit is exceeded, the temperature diagnosis is not activated until the parameterized delay time has elapsed. The temperature diagnosis function can thus be explicitly deactivated, e.g. if the temperature drops temporarily owing to the closure of the sealing jaws.

! The lower and upper tolerance band limits cannot be set in the ROPEX visualization software. The same limits apply as for the TO bit. They can only be set by means of the PROFIBUS parameter data (↪ section 10.7 "Parameter data" on page 30) or the DPV1 protocol extension (↪ section 10.8 "DPV1 protocol extension (as of GSD Version v2.0)" on page 35).

10.7.12 Heatup timeout (as of GSD Version v2.0)

An additional heatup timeout can be activated by means of the PROFIBUS parameter data or the DPV1 protocol extension.

This timeout starts when the „START“ bit is activated. The RES-406 then monitors the time required for the ACTUAL temperature to reach 95% of the SET temperature. If this time is longer than the parameterized time, the corresponding error code (304) is indicated and the alarm relay is switched (↪ section 10.16 "Error messages" on page 41).

! The "Heatup timeout" function must be activated by means of the PROFIBUS parameter data (↪ section 10.7 "Parameter data" on page 30) or the DPV1 protocol extension (↪ section 10.8 "DPV1 protocol extension (as of GSD Version v2.0)" on page 35). (default setting: Heatup timeout off)

10.7.13 Hold mode (as of GSD Version v2.0)

The behavior of the digital indication of the ACTUAL temperature via the PROFIBUS communication is set by means of the parameters data or the DPV1 protocol extension as followed:

1. "off" (Factory setting)
The real ACTUAL temperature is always indicated.
2. "on"
The ACTUAL temperature that was valid at the end of the last heatsealing phase is always indicated as a digital value. When the controller is switched on, the real ACTUAL temperature is indicated until the end of the first heating phase.
3. "2 s"
It causes the current ACTUAL temperature to be displayed as a digital value for an additional 2 seconds at the end of a heatsealing phase. This temperature is then indicated again in real time until the end of the next heating phase.

! Hold mode affects the digital value of the real temperature in the PROFIBUS communication and the numeric temperature display in the ROPEX visualization software only. The output of the real temperature on the actual value output and the data record in the graphics window of the ROPEX visualization software is not affected.

The various hold modes are shown below:

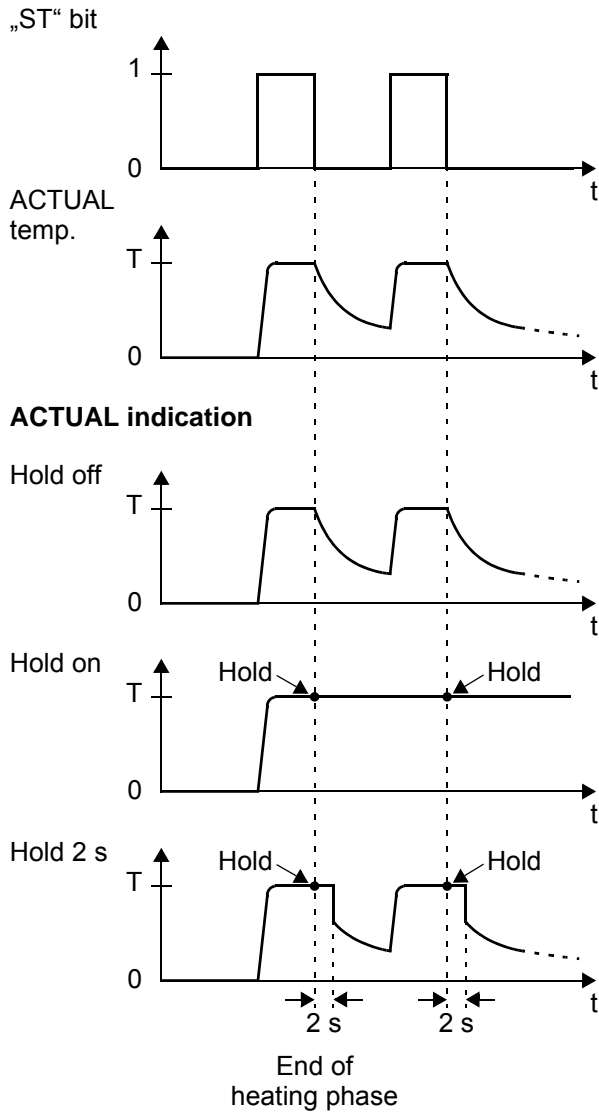

! The "Holde mode" function must be activated by means of the PROFIBUS parameter data (↪ section 10.7 "Parameter data" on page 30) or the DPV1 protocol extension (↪ section 10.8 "DPV1 protocol extension (as of GSD Version v2.0)" on page 35). (default setting: Hold mode off).

10.8 DPV1 protocol extension (as of GSD Version v2.0)

Text in preparation.

10.8.1 Identification and maintenance (I&M functions)

Text in preparation.

10.8.2 DPV1 alarm model

Text in preparation.

10.8.3 DPV1 parameter data

The basic controller settings and functions can be set with the parameter data in the device master file (GSD file, ↗ section 10.7 "Parameter data" on page 30).

Some PLC systems only allow you to change the settings in the GSD file when you create a new project. The settings cannot be changed while the machine or system is operating.

The DPV1 protocol extension makes it possible to change these settings and functions without interrupting the operation of the controller. The temperature coefficient for the heatsealing band, for instance, can

be altered on the PLC control unit during the validation process.

This acyclic service supports both reading and writing of the controller parameters. The parameter data can optionally be accessed by addressing the slot indexes. Since the controller does not store parameters transferred to it in this way, you must remember to transfer all parameters that deviate from the static configuration again after restarting the controller or the bus.



Please contact the manufacturer for more information about how your PLC system supports the DPV1 protocol extension.

DPV1 parameter table of the RES-406

Default values are printed *bold/cursive*.

Slot	Index	Parameter	Value range
x	255	I&M functions (IMO)	Article number, serial number, version index, manufacturer ID
0	0	Cyclic data	↗ section 10.4 "PROFIBUS protocol" on page 24
1	4	Alloy/range	0: 1100ppm/K, 300 °C 1: 780ppm/K, 300 °C 4: 1100ppm/K, 500 °C 5: 780ppm/K, 500 °C 8: 3500ppm/K, 300 °C 9: PC configuration 10: Rotary coding switch 11: variable
1	5	Lower temperature limit [K]	3...99 (10)
1	6	Upper temperature limit [K]	3...99 (10)
1	7	Calibration temperature [°C]	-1: variable with cyclic data 0...40 (20)
1	8	Heating time limit [0.1 s steps]	0...250 (0=without limit)
1	9	Extended controller diagnosis	0: deactivated 1: activated
1	10	Measuring pulse length [0.1 ms steps]	17...30 (17)
1	11	Data format	0: Intel 1: Motorola
1	12	Error code format	0: 4 bit (2 digits) 1: 10 bit (4 digits)
1	13	Temperature coefficient [ppm/K]	400...4000 (1100)

Slot	Index	Parameter	Value range
1	15	Temperatur range	0: 200°C 1: 300°C 2: 400°C 3: 500°C
1	16	Maximum temperature [°C]	200...500 (300)
1	18	Temperature diagnosis	0: deactivated 1: activated
1	19	Temperature diagnosis delay time [0.1 s steps]	0...99 (0)
1	20	Heatup timeout [0.1s steps]	0...999 (0)
1	22	AUTOCOMP	0: off 1: on 2: AUTO (as of software revision 105)
1	23	„TO“ bit (Temperature OK)	0: off 1: active if Tact=Tset 2: active if Tact=Tset, with latch
1	24	Hold mode	0: off 1: on 2: 2s

10.9 Temperature indication (actual value output)

The RES-406 supplies an analog 0...10VDC signal, which is proportional to the real ACTUAL temperature, at terminals 17+18.

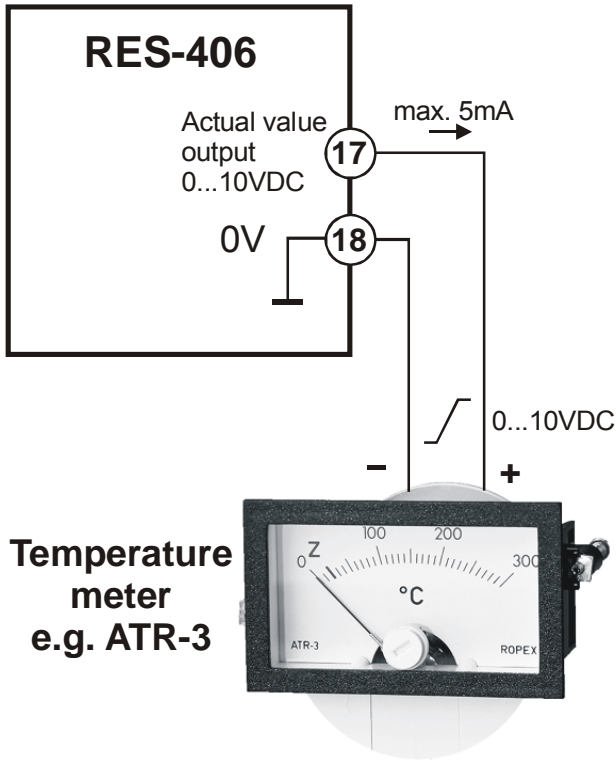

Temperature meter
e.g. ATR-3

Voltage values:
 0VDC → 0°C
 10VDC → 300°C or 500°C
 (depending on the controller configuration)

The relationship between the change in the output voltage and the ACTUAL temperature is linear.

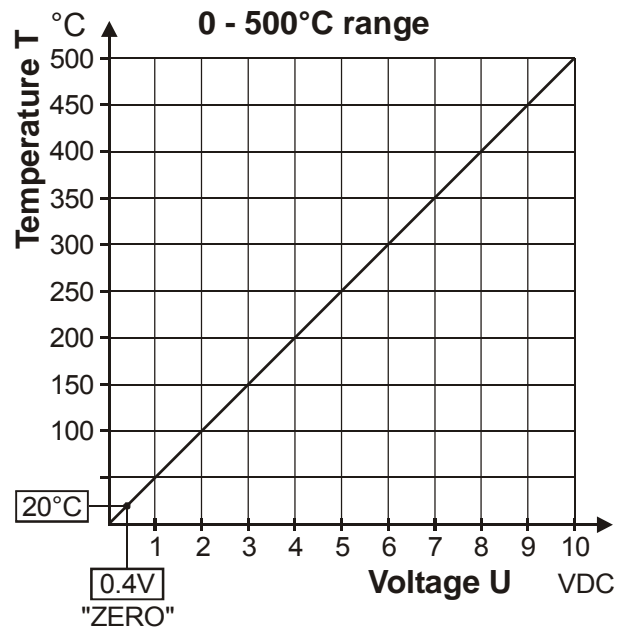
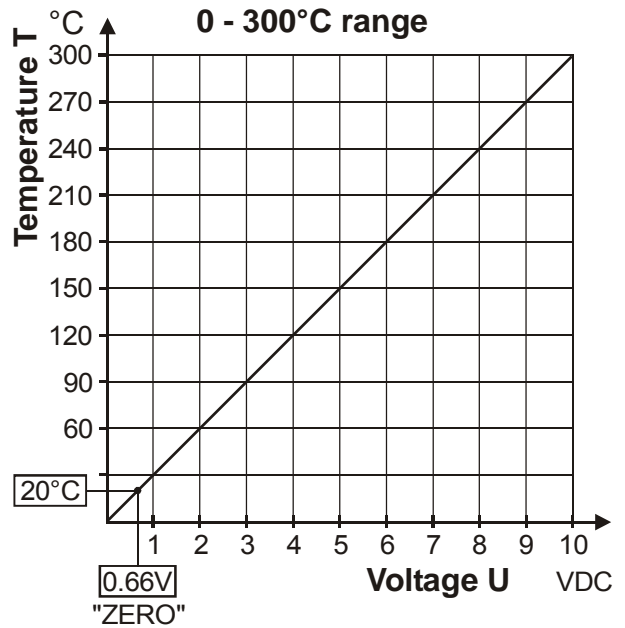

An indicating instrument can be connected to this output in order to visualize the temperature of the heatsealing band.

The characteristics of the ROPEX ATR-x temperature meter (size, scaling, dynamic response) are ideally suited to this application and this instrument should therefore always be used (↪ section 5 "Accessories and modifications" on page 6).

It not only facilitates SET-ACTUAL comparisons, but also enables other criteria such as the heating rate, set point reached within the specified time, cooling of the heatsealing band etc. to be evaluated.

This meter moreover permits disturbances in the control loop (loose connections, contacting or wiring problems) as well as any line disturbances to be observed extremely effectively and interpreted accordingly. The same applies if mutual interference occurs between several neighboring control loops.

⚠ This output is not potential-free and might have the potential of the secondary voltage of the impulse transformer. External grounding is not allowed. If this warning is ignored, the controller will be damaged by frame currents. Contact-voltage protection must be installed at the terminals of the external temperature meter.

If an alarm is signaled, the analog output at terminals 14+18 is used to display a selective error message (↪ section 10.16 "Error messages" on page 41).

10.10 Booster connection

The RES-406 controller has a connection for an external switching amplifier (booster) as standard. This connection (at terminals 15+16) is necessary for high primary currents (continuous current > 5A, pulsed current > 25A). The switching amplifier should be connected as described in section 8.7 "Wiring diagram with booster connection" on page 15.

10.11 Diagnostic interface/visualization software (as of February 2006)

An interface with a 6-pole Western socket is provided for systemdiagnostics and process visualization. This interface allows a data connection to be set up to the

ROPEX visualization software using the ROPEX communication interface CI-USB-1.

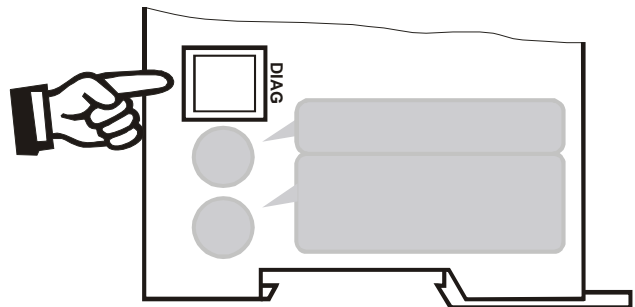

⚠ Only a ROPEX communication interface is allowed to be connected to the diagnostic interface. Connecting another device (e.g. a telephone cable) could result in malfunctions or damage to the controller.

The ROPEX visualization software is described in a separate document.

10.12 Total cycle counter (as of February 2006)

The number of heatsealing cycles executed since the controller was first delivered is stored internally (ST bit = 1). This counter can only be displayed and not reset. It can only be displayed in the ROPEX visualization software (↪ section 10.11 "Diagnostic interface/visualization software (as of February 2006)" on page 39).

10.13 Operating hours counter (as of February 2006)

The number of operating hours since the controller was first delivered is stored internally. This counter works with a resolution of six minutes. It can only be displayed and not reset. It can only be displayed in the ROPEX visualization software (↪ section 10.11 "Diagnostic interface/visualization software (as of February 2006)" on page 39).

10.14 Log function (as of software revision 107)

As of software revision 107, the RES-406 has a storage function for logging error messages (↪ section 10.16 "Error messages" on page 41) and zero calibrations (AUTOCAL function, ↪ section 10.5.1 "Automatic zero calibration "AUTOCAL" (AC)" on page 26). The log shows the 30 most recent messages. The message log is stored together with the total cycle counter and the operating hours counter. This log can only be displayed and not deleted. It can only be displayed in the ROPEX visualization software (↪ section 10.11 "Diagnostic interface/visualization software (as of February 2006)" on page 39).

The log function for error messages and zero calibrations (AUTOCAL function) allows you to evaluate operating states at a later point in time, simplifying fault analyses.

10.15 System monitoring/alarm output

To increase operating safety and to avoid faulty heatsealing, this controller incorporates special hardware and software features that facilitate selective fault detection and diagnosis. Both the external wiring and the internal system are monitored.

These features assist the operator in identifying the cause of abnormal operations.

A system fault is reported or differentiated by means of the following indications.

A.) Red "ALARM" LED on the controller with three states:

1. Blinks fast (4Hz)

The AUTOCAL function should be executed (error codes 8+9; as of February 2006 also: 104...106, 211, 302, 303).

2. Blinks slowly (1Hz)

The system configuration is incorrect and the zero calibration (AUTOCAL function) was unsuccessful (↪ section 9.2 "Controller configuration" on page 16). It corresponds to error codes 10...12 (as of February 2006 also: 111...114).

3. Lit continuously:

This indicates that a fault is preventing the controller from being started (error codes 1...7; as of February 2006 also: 101...103, 107, 108, 201...203, 307, 308, 801, 9xx).

As a rule, it refers to an external wiring fault.

B.) Alarm relay (relay contact terminals 12+13+14):

This relay is set in the factory as follows:

- **DE-ENERGIZED** in operating states A.1 and A.2, but energized if the "ST" bit is activated in one of these states.
- **ENERGIZED** in operating state A.3.

If the alarm relay is configured opposite to the factory setting (↪ section 9.2.4 "Configuration of the alarm relay" on page 18), these states are reversed.

C.) Error code indication via the PROFIBUS protocol

If a fault occurs the "AL" bit is set and in the compact protocol the error code appears instead of the actual value in bits 0...3, while in the extended protocol it is contained at bit positions 8...11 in the second word (↪ section 10.6.9 "Error codes" on page 29).

D.) Error code output via the 0...10VDC analog output (terminals 17+18):

Since a temperature indication is no longer necessary if a fault occurs, the analog output is used to display error messages in the event of an alarm.

13 voltage levels (up to January 2006: 12 voltage levels) are offered for this purpose in the 0...10VDC range, each of which is assigned an error code (↪ section 10.16 "Error messages" on page 41).

If a state that requires AUTOCAL occurs – or if the controller configuration is not correct – (error codes 8...12; as of February 2006 also: 104...106, 111...114, 211, 302, 303), the signal at the analog output jumps back and forth at 1Hz between the voltage value which corresponds to this error and the end of the scale (10VDC, i.e. 300°C or 500°C). If the "ST" bit is activated in one of these states, the voltage value does not change any more.

Selective fault detection and indication can thus be implemented simply and inexpensively using the analog input of a PLC with a corresponding error message (↪ section 10.16 "Error messages" on page 41).

 **An alarm can only be reset by activating the „RS“ bit or by switching the controller off and then on again.**

 **If an error message is reset using the "RS" bit, the "RS" bit must be deactivated first.**

 **Invalid error messages may appear when the controller is switched off owing to the undefined operating state. This must be taken into account when they are evaluated by the higher-level controller (e.g. a PLC) in order to avoid false alarms.**

10.16 Error messages

In addition to the fault diagnosis which is coded in the protocol, you can also access the PROFIBUS diagnostics function (extended controller diagnosis). The error codes appear in the configuring tool in plain text, because they are stored in the device master file.

The table below shows how the analog voltage values correspond with the faults that have occurred. It also describes the fault and the required corrective action. The error messages are listed in two separate tables for controllers "up to January 2006" and "as of February 2006". The block diagram in section 10.17 "Fault areas and causes" on page 46 permits each fault to be cleared quickly and efficiently.

13 voltage levels for fault diagnostics appear at the actual value output of all controllers manufactured as of February 2006. The error messages are differentiated even more finely in the controller. The 3-digit error codes described in brackets below can be displayed with the ROPEX visualization software (↪ section 10.11 "Diagnostic interface/visualization software (as of February 2006)" on page 39) to facilitate troubleshooting.

 **If the actual value output is evaluated in order to identify an error message - in the higher-level controller, for instance - the tolerance window must be adjusted to prevent it from being incorrectly interpreted. Please note the tolerances of the actual value output (↪ section 6 "Technical data" on page 8).**

Error messages as of February 2006									
Part 1 of 3:			Error messages as of February 2006						
Error code	Act. value output; Voltage [V]	Temp. 300 °C [°C]	Temp. 500 °C [°C]	ALARM LED	STATUS of alarm relay (factory set.)	Cause	Action if machine started for first time	Action if machine already operating, HS band not chang.	
1 (101)	0.66	20	33	Lit continuously	Energized	I _R signal missing	Fault area ①	Fault area ①	
2 (102)	1.33	40	66			U _R signal missing	Fault area ③	Fault area ③	
3 (103)	2.00	60	100			U _R and I _R signals missing	Fault area ②	Fault area ②⑨	
(107) (108)						Temperature step, down Temperature step, up	Fault area ④⑤⑥ (loose contact)	Fault area ④⑤⑥ (loose contact)	
4 (307) (308) (309) (310)	2.66	80	133			Temperature too low/high (↳ section 10.7.11)			
5 (201) (202) (203)	3.33	100	166			Frequency fluctuation, inadmissible line frequency	Check power supply	Check power supply	
6 (304)	4.00	120	200			Heatup time too long (↳ section 10.7.12)	Run RESET	Run RESET	
(901) (913) (914) (915) (916)	4.66	140	233			no line voltage/Sync-Sig. Triac defective Int. fault, contr. defective Int. fault, contr. defective Int. fault, contr. defective	↳ Kap. 10.2 Replace controller Replace controller Replace controller Replace controller	↳ Kap. 10.2 Replace controller Replace controller Replace controller Replace controller	
(917) (918)						Plug-in jumper for alarm output wrong	Check plug-in jumper	Check plug-in jumper	

Part 2 of 3: Error messages as of February 2006

NOTE: The specified error messages are initially output as warnings (actual value output jumps back and forth between two values; alarm LED blinks; alarm relay is de-energized). When the "START" signal is activated, the warning changes to a fault (actual value output no longer jumps back and forth, see *bold italic values*; alarm LED lit continuously; alarm relay is energized).

Error code	Act. value output; Volt. [V]	Temp. 300 °C [°C]	Temp. 500 °C [°C]	ALARM LED	STATUS of alarm relay (factory set.)	Cause	Action if machine started for first time	Action if machine already operating, HS band not chang.
(104)						I _R signals incorrect, incorrect specification of impulse-transformer		
(105)						U _R signals incorrect, incorrect specification of impulse-transformer	Run AUTOCAL , Check specification of transformer, Fault area ⑦ ⑧	
8	↕ 5.33 ↗ ↕ 10 ↗	↕ 160 ↗ ↕ 300 ↗	↕ 266 ↗ ↕ 500 ↗	Warning: Blinks fast (4Hz) Fault: Lit continuously	Warning: De-Energized Fault: Energized (voltage value at actual value output then no longer changes)	U _R and/or I _R signals incorrect, incorrect specification of impulse-transformer	Run AUTOCAL and/or fault area ④ ⑤ ⑥ (loose contact)	Fault area ④ ⑤ ⑥ (loose contact)
						Temperature too low, AUTOCAL wasn't performed, loose contact, ambient temp. fluctuates		
(302)						temperature too high, AUTOCAL wasn't performed, loose contact, ambient temp. fluctuates		
(303)								
9	↕ 6.00 ↗ ↕ 10 ↗	↕ 180 ↗ ↕ 300 ↗	↕ 300 ↗ ↕ 500 ↗			Data error	Run AUTOCAL	---

Part 3 of 3: Error messages as of February 2006

NOTE: The specified error messages are initially output as warnings (actual value output jumps back and forth between two values; alarm LED blinks; alarm relay is de-energized). When the "START" signal is activated, the warning changes to a fault (actual value output no longer jumps back and forth, see **bold italic values**; alarm LED lit continuously; alarm relay is energized).

Error code	Act. value output; Volt. [V]	Temp. 300 °C [°C]	Temp. 500 °C [°C]	ALARM LED	STATUS of alarm relay (factory set.)	Cause	Action if machine started for first time	Action if machine already operating, HS band not chang.
10 (111)	↔ 6.66↔ ↳ 10 ↲	↔ 200↔ ↳ 300 ↲	↔ 333↔ ↳ 500 ↲		Warning: De-Energized	I _R signal incorrect, calibration not possible	Fault area ⑧, check configuration	---
11 (112)	↔ 7.33↔ ↳ 10 ↲	↔ 220↔ ↳ 300 ↲	↔ 366↔ ↳ 500 ↲			U _R signal incorrect, calibration not possible	Fault area ⑦, check configuration	---
12 (113)	↔ 8.00↔ ↳ 10 ↲	↔ 240↔ ↳ 300 ↲	↔ 400↔ ↳ 500 ↲	Warning: Blinks slowly (1Hz)		U _R and I _R signals incorrect, calibration not possible	Fault area ⑦⑧, check configuration	---
(114)				Fault: Lit continuously	Fault: Energized (voltage value at actual value output then no longer changes)	Temperature fluctuates, calibration not possible		
13 (115)	↔ 8.66↔ ↳ 10 ↲	↔ 260↔ ↳ 300 ↲	↔ 433↔ ↳ 500 ↲			Ext. calibration temperature too high, calibration not possible		
(116)						Ext. calibration temperature fluctuates calibration not possible		

Error messages up to January 2006											
Error code	Act. value output ; Voltage [V]	Temp. 300 °C [°C]	Temp. 500 °C [°C]	ALARM LED	STATUS of alarm relay (factory set.)	Cause	Action if machine started for first time	Action if machine already operating, HS-band not chang.			
1	0.66	20	33	Lit Continuously	Energized	I _R signal missing	Fault area ①	Fault area ①			
2	1.33	40	66			U _R signal missing	Fault area ③	Fault area ③			
3	2.00	60	100			U _R and I _R signals missing	Fault area ②	Fault areas ②⑨			
4	2.66	80	133	Lit Continuously	Energized	Temperature step	Fault areas ④⑤⑥ (loose contact)	Fault areas ④⑤⑥ (loose contact)			
5	3.33	100	166			Frequency fluctuation, inadmissible line frequency	Check power supply	Check power supply			
6	4.00	120	200	Lit Continuously	Energized	Internal fault	Run RESET	Run RESET			
7	4.66	140	233			Internal fault, controller defective	Replace controller	Replace controller			
8	↺ 5.33 ↻ ↺ 10 ↻	↺ 160 ↻ ↺ 300 ↻	↺ 266 ↻ ↺ 500 ↻	Blinks fast (4Hz)	De-Energized, gets energized with "START" signal (voltage value at analog output then no longer changes)	U _R and/or I _R signal incorrect	Run AUTOCAL	Fault areas ④⑤⑥			
9	↺ 6.00 ↻ ↺ 10 ↻	↺ 180 ↻ ↺ 300 ↻	↺ 300 ↻ ↺ 500 ↻	Blinks slowly (1Hz)		Data error	Run AUTOCAL	---			
10	↺ 6.66 ↻ ↺ 10 ↻	↺ 200 ↻ ↺ 300 ↻	↺ 333 ↻ ↺ 500 ↻		I _R signal incorrect, calibration not possible	Fault area ⑧, check configuration	---				
11	↺ 7.33 ↻ ↺ 10 ↻	↺ 220 ↻ ↺ 300 ↻	↺ 365 ↻ ↺ 500 ↻	Blinks slowly (1Hz)	U _R signal incorrect, calibration not possible	Fault area ⑦, check configuration	---				
12	↺ 8.00 ↻ ↺ 10 ↻	↺ 240 ↻ ↺ 300 ↻	↺ 400 ↻ ↺ 500 ↻		U _R and I _R signals incorrect, calibration not possible	Fault areas ⑦⑧, check configuration	---				

10.17 Fault areas and causes

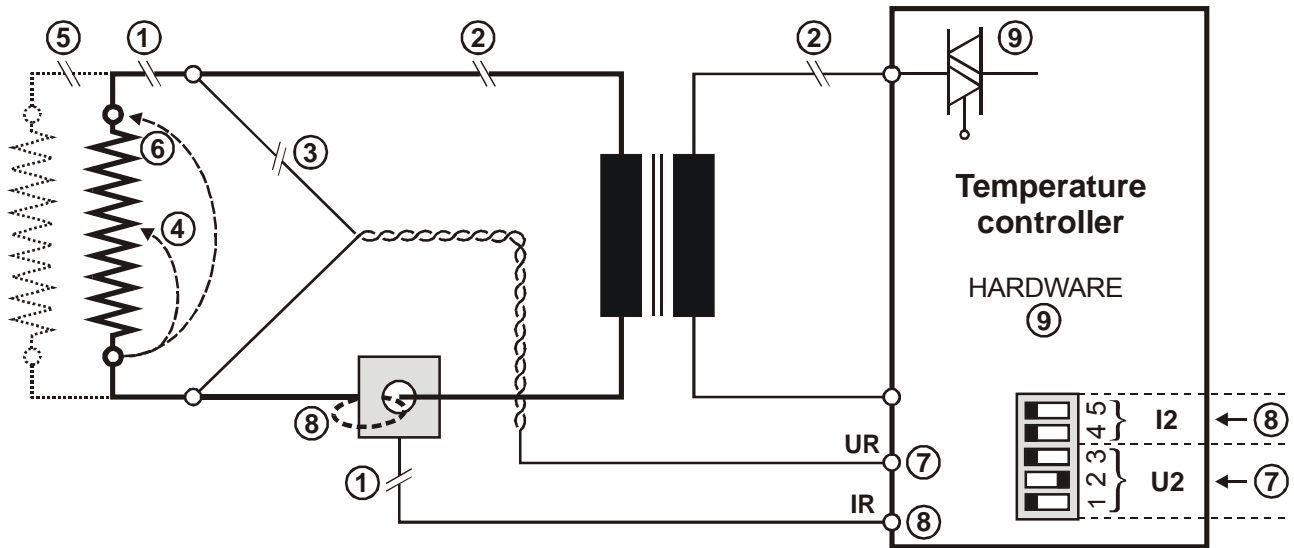

The table below explains the possible fault causes.





Fault area	Explanation	Possible causes
①	Load circuit interrupted after U_R pickoff point	- Wire break, heatsealing band break - Contact to heatsealing band is defective
	PEX-W2/-W3 current transformer signal interrupted	- I_R measuring wires from current transformer interrupted
②	Primary circuit interrupted	- Wire break, triac in controller defective - Primary winding of impulse transformer interrupted
	Secondary circuit interrupted before U_R -pickoff point	- Wire break - Secondary winding of impulse transformer interrupted
③	U_R signal missing	- Measuring wires interrupted
④	Partial short-circuit (ΔR)	- Heatsealing band partially bypassed by conducting part (clamp, opposite heatsealing bar etc.)
⑤	Parallel circuit interrupted	- Wire break, heatsealing band break - Contacting to heatsealing band defective
⑥	Total short-circuit	- Heatsealing band installed incorrectly, insulation at heatsealing bar ends missing or incorrectly installed - Conducting part bypasses heatsealing band completely
⑦	U_R signal incorrect	- Up to Jan. 2006: DIP switches 1 - 3 configured incorrectly (U_2 range) - As of Feb. 2006: U_2 outside permissible range from 0.4...120VAC

Fault area	Explanation	Possible causes
⑧	I_R signal incorrect	- Up to Jan. 2006: DIP switches 4 + 5 configured incorrectly (I_2 range) - As of Feb. 2006: I_2 outside permissible range from 30...500A
	Turns through PEX-W2/-W3 current transformer incorrect	- Check number of turns (two or more turns required for currents < 30A)
⑨	Internal controller fault	- Hardware fault (replace controller) - Plug-in jumper for alarm output not connected or incorrectly connected

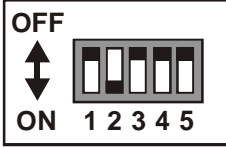
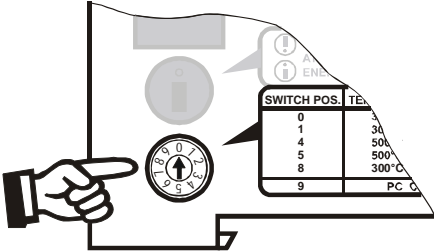
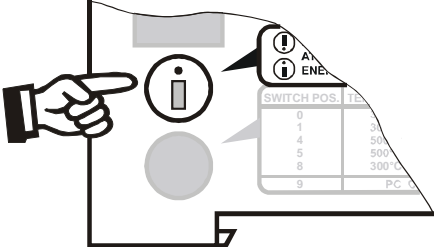
11 Factory settings

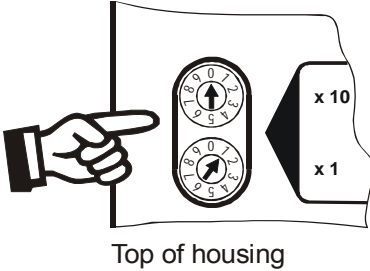
The RESISTRON temperature controller RES-406 is configured in the factory as follows:

<p><u>DIP switches</u> for secondary voltage U_2 and current I_2 (up to January 2006)</p>		<p>$U_2 = 6...60VAC$ $I_2 = 30...100A$</p> <p>DIP switches: 2 ON 1, 3, 4, 5 OFF</p> <p>These switches are automatically set by the AUTORANGE function on all controllers manufactured as of February 2006.</p>
<p><u>Rotary coding switch</u> for heatsealing band alloy and temperature range</p>		<p>Heatsealing band alloy: Alloy-20 Temperature range: 300°C</p> <p>Rotary coding switch: "0" position</p>
<p><u>Plug-in jumper</u> for alarm relay</p>		<p>Alarm relay is energized at alarm</p>

<p><u>Rotary coding switches</u> for station address</p>	 <p>Top of housing</p>	<p>Station address = 01_{dec}</p>
<p><u>Automatic phase angle compensation</u> (AUTOCOMP) [X]</p>		<p>AUTOCOMP: off</p>
<p><u>Temperature diagnosis</u> [X]</p>		<p>Temperature diagnosis: deactivated</p>
<p><u>Heatup timeout</u> [X]</p>		<p>Heatup timeout: deactivated</p>







[X] As of February 2006 and GSD Version v2.0:
Setting by means of the PROFIBUS parameter data
or the DPV1 protocol extension.

12 Maintenance

The controller requires no special maintenance. Regular inspection and/or tightening of the terminals – including the terminals for the winding connections on

the impulse transformer – is recommended. Dust deposits on the controller can be removed with dry compressed air.

13 How to order

	<p>Contr. RES - 406 / . . . VAC</p> <ul style="list-style-type: none"> → 115: Power supply 115VAC, Art. No. 740601 → 230: Power supply 230VAC, Art. No. 740602 → 400: Power supply 400VAC, Art. No. 740603 <p>Scope of supply: Controller includes connector plug-in parts (without current transformer)</p> <p>Modification MOD . . (optional, if required)</p> <ul style="list-style-type: none"> e.g. → 01: MOD 01, Art. No. 800001 (Amplifier for low voltage) <p>Please indicate the article numbers of the controller and the required modifications (optional) in all orders, e.g. RES-406/400VAC + MOD 01 (controller for 400VAC power supply with amplifier for low voltage) Art. No. 740603 + 800001 must be ordered</p>
	<p>Current transformer PEX-W3 Art. No. 885105</p>
	<p>Line filter LF- . . 480</p> <ul style="list-style-type: none"> → 06: Continuous current 6A, 480VAC, Art. No. 885500 → 35: Continuous current 35A, 480VAC, Art. No. 885506
	<p>Impulse transformer</p> <p>See ROPEX Application Report for design and ordering information</p>
	<p>Communication interface CI-USB-1 Art. No. 885650</p>
	<p>Temp. meter ATR- .</p> <ul style="list-style-type: none"> → 3: 300°C range, Art. No. 882130 → 5: 500°C range, Art. No. 882150
	<p>Booster B- . . . 400</p> <ul style="list-style-type: none"> → 075: Max. pulse load 75A, 400VAC, Art. No. 885301 → 100: Max. pulse load 100A, 400VAC, Art. No. 885304

For more accessories: ↪ "Accessories" leaflet

14 Index

Nummern

24VDC-Supply voltage 8

A

"AA" bit 28
 "AC" bit 26
 Actual value 29
 Actual value output 38
 "AG" bit 28
 "AL" bit 20, 28
 Alarm 28
 Alarm output 40
 Alarm relay 9, 18
 Alloy 17, 20
 Ambient temperature 9
 Analog temperature meter 6
 Application 4
 Application Report 10, 13, 16
 AUTOCAL 6, 20
 Active 28
 Disabled 26, 28
 Starting 26
 AUTOCOMP 32
 Automatic phase angle compensation 32
 Automatic zero calibration 6, 20, 26
 AUTOTUNE 6

B

Booster 7, 15, 49
 Booster connection 39
 Burning in the heatsealing band 18, 20

C

Circuit-breaker 12
 CI-USB-1 7, 39, 49
 Communication interface 7, 39, 49
 Controller active 29
 Controller configuration 16
 Controller diagnosis 32
 Current transformer 7, 13, 49

D

Data format 32
 Degree of protection 9
 Device master file (GSD) 23
 Diagnostic interface 39
 Digital temperature meter 6
 Dimensions 10
 DIP switches 16
 DPV1 protocol extension 35

E

Error code format 32

Error messages 41
 Extended controller diagnosis 32
 External switching amplifier 7, 15

F

Factory settings 47
 Fault areas 46
 Fault diagnosis 6
 Fuse 12

G

GSD 23

H

Heatsealing band type 8
 Heatup timeout 34

I

Impulse heatsealing method 4
 Impulse transformer 7, 12, 49
 Input data 26
 Installation 9, 10
 Installation procedure 10
 Installation regulations 11

L

Line filter 6, 12, 13, 49
 Line frequency 6, 8
 Line voltage 8
 Log function 40

M

Maintenance 48
 Measurement cable 7
 Measurement pause 27
 Measuring impulse duration 32
 Modifications (MODs) 7, 49
 MODs 7, 49
 Monitoring current transformer 7
 "MP" bit 27

O

Operating hours counter 39
 Output data 28
 Over-current protection 12
 Overheating of heatsealing band 6

P

PEX-W2/-W3 3
 PEX-W3 13, 49
 Phase angle compensation 32
 Power dissipation 9

Power supply 12, 49
Principle of operation 5
PROFIBUS-DP interface 8
Protocol
 Compact, 10-Bit error code 24
 Compact, 4-Bit error code 24
 Extended, 10-Bit error code 25
 Extended, 4-Bit error code 25

R
"RA" bit 20, 29
Replacing the heatsealing band 19, 20
Reset 27
"RS" bit 27

S
Secondary current I_2 16
Secondary voltage U_2 16
Set point 28
Start 27
"START" bit 20
Startup 16
System diagnostics 39
System monitoring 40

T
TCR 3, 18
"TE" bit 28
Temperature coefficient 3, 18
Temperature control 4
Temperature diagnosis 33
Temperature indication 38
Temperature meter 6, 38, 49
Temperature OK 28
Temperature range 8, 17
Temperature reached 28
"TO" bit 28
Total cycle counter 39
Transformer 3, 7, 12, 49
Type of construction 8

V
View of the controller 16
Visualization software 39

W
Wiring 11, 12
Wiring diagram 14, 15