

DATI TECNICI / TECHNICAL DATA / TECHNISCHE DATEN
 CARACTÉRISTIQUES TECHNIQUES / DATOS TÉCNICOS / CARACTERÍSTICAS TÉCNICAS

CV RCV	i	n ₁ = 2800 min ⁻¹			n ₁ = 1400 min ⁻¹			n ₁ = 900 min ⁻¹					
		n ₂ min ⁻¹	Mn ₂ Nm	P ₁ kW	n ₂ min ⁻¹	Mn ₂ Nm	P ₁ kW	n ₂ min ⁻¹	Mn ₂ Nm	P ₁ kW	IEC B5	IEC B14	NEMA
302	3.74	749	203	16.6	374	243	9.9	241	243	6.4	71-80-90-100/112-132	100-112-132	140-180
	4.56	614	215	14.4	307	258	8.6	197	258	5.6	71-80-90-100/112-132	100-112-132	140-180
	5.11	548	210	12.6	274	251	7.5	176	252	4.8	71-80-90-100/112-132	100-112-132	140-180
	6.22	450	211	10.4	225	253	6.2	145	253	4.0	71-80-90-100/112-132	100-112-132	140-180
	6.93	404	211	9.3	202	252	5.6	130	252	3.6	71-80-90-100/112-132	100-112-132	140-180
	7.78	360	218	8.6	180	261	5.1	116	261	3.3	71-80-90-100/112-132	100-112-132	140-180
	7.51	373	206	8.4	186	246	5.0	120	246	3.2	71-80-90-100/112-132	100-112-132	140-180
	9.14	306	241	8.1	153	288	4.8	98	289	3.1	71-80-90-100/112-132	100-112-132	140-180
	10.18	275	247	7.4	138	296	4.4	88	297	2.9	71-80-90-100/112-132	100-112-132	140-180
	11.43	245	254	6.8	122	305	4.1	79	304	2.6	71-80-90-100/112-132	100-112-132	140-180
	12.62	222	233	5.6	111	279	3.4	71	279	2.2	71-80-90-100/112	100-112	140-180
	15.37	182	246	4.9	91	295	2.9	59	295	1.9	71-80-90-100/112	100-112	140-180
	17.11	164	253	4.5	82	303	2.7	53	302	1.7	71-80-90-100/112	100-112	140-180
	19.21	146	259	4.1	73	310	2.5	46.9	310	1.6	71-80-90-100/112	100-112	140-180
	24.19	116	239	3.0	58	285	1.8	37.2	285	1.2	71-80-90-100/112	100-112	140-180
	29.45	95	251	2.6	47.5	300	1.6	30.6	300	1.0	71-80-90-100/112	100-112	140-180
32.80	85	257	2.4	42.7	308	1.4	27.4	308	0.92	71-80-90-100/112	100-112	140-180	
36.82	76	263	2.2	38.0	315	1.3	24.4	316	0.84	71-80-90-100/112	100-112	140-180	
303	41.20	68	258	2.0	34.0	310	1.2	21.8	308	0.76	63-71-80-90	90	56-140
	46.20	61	264	1.8	30.3	316	1.1	19.5	316	0.69	63-71-80-90	90	56-140
	54.00	52	242	1.4	25.9	290	0.85	16.7	290	0.54	63-71-80-90	90	56-140
	65.80	42.6	253	1.2	21.3	304	0.73	13.7	304	0.47	63-71-80-90	90	56-140
	73.30	38.2	260	1.1	19.1	310	0.67	12.3	310	0.43	63-71-80-90	90	56-140
	82.20	34.1	265	1.0	17.0	317	0.61	10.9	318	0.39	63-71-80-90	90	56-140
	99.30	28.2	243	0.77	14.1	292	0.46	9.1	291	0.30	63-71-80-90	90	56-140
	120.90	23.2	256	0.67	11.6	306	0.40	7.4	306	0.26	63-71-80-90	90	56-140
	134.70	20.8	261	0.61	10.4	314	0.37	6.7	313	0.24	63-71-80-90	90	56-140
	151.10	18.5	268	0.56	9.3	320	0.33	6.0	320	0.21	63-71-80-90	90	56-140
	189.20	14.8	249	0.42	7.4	299	0.25	4.8	298	0.16	63-71-80-90	90	56-140
	230.30	12.2	267	0.37	6.1	320	0.22	3.9	319	0.14	63-71-80-90	90	56-140
	256.50	10.9	279	0.34	5.5	334	0.21	3.5	335	0.13	63-71-80-90	90	56-140
	287.90	9.7	288	0.32	4.9	346	0.19	3.1	345	0.12	63-71-80-90	90	56-140

DIMENSIONI / DIMENSIONS / ABMESSUNGEN / DIMENSIONS / DIMENSIONES / DIMENSÕES

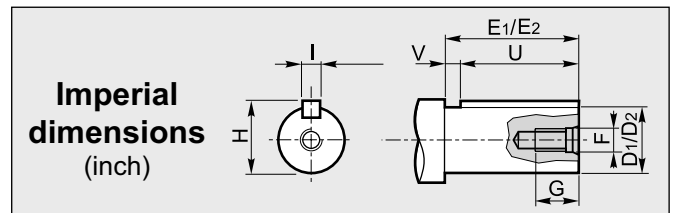
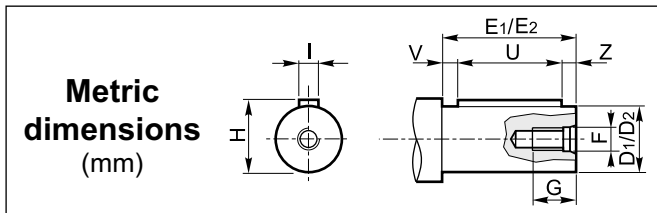

1 **Albero entrata / Input shaft / Antriebswelle**
Arbre d'entrée / Eje de entrada / Eixo de entrada

CV	D ₁	E ₁	F	G	H	I	U	V	Z
302	24	50	M8	18	27	8	40	5	5
303	19	40	M6	15	21.5	6	30	5	5

2 **Albero uscita / Output shaft / Abtriebswelle**
Arbre de sortie / Eje de salida / Eixo de saída

CV RCV	D ₂	E	F	G	H	I	U	V
302 303	30.16 (1.187)	60 (2.362)	3/8-16	23 (0.906)	32.99 (1.299)	6.35 (0.250)	44.45 (1.750)	15.55 (0.612)

(Inch)

2 **Albero uscita / Output shaft / Abtriebswelle**
Arbre de sortie / Eje de salida / Eixo de saída

CV RCV	D ₂	E	F	G	H	I	U	V	Z
302 303	28	60	M8	18	31	8	50	5	5
	30	60	M10	22	33	8	50	5	5
	32	75	M10	22	35	10	60	7.5	7.5
	35	80	M10	22	38	10	70	5	5
	38	80	M10	22	41	10	70	5	5
	40	80	M12	28	43	12	70	5	5

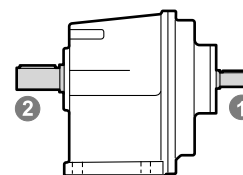

A richiesta / On request / Auf Anfrage / Sur demande / Bajo demanda / Sob consulta

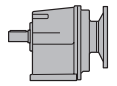

DIMENSIONI / DIMENSIONS / ABMESSUNGEN / DIMENSIONS / DIMENSIONES / DIMENSÕES

P

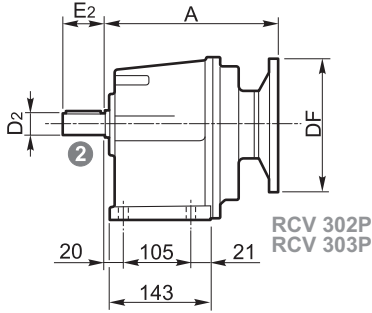

RCV 302P
RCV 303P

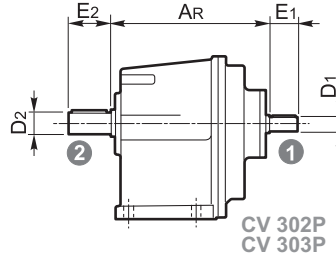

CV 302P
CV 303P

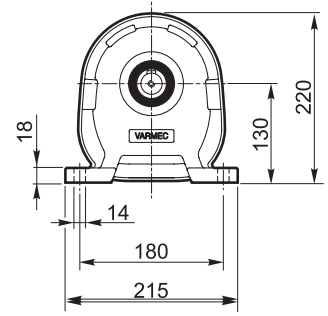

F

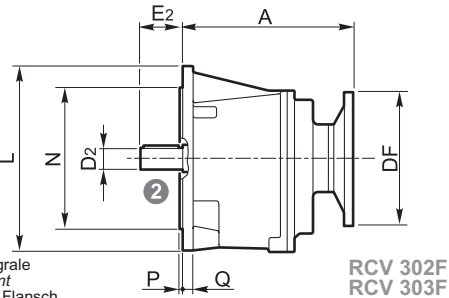

RCV 302F
RCV 303F

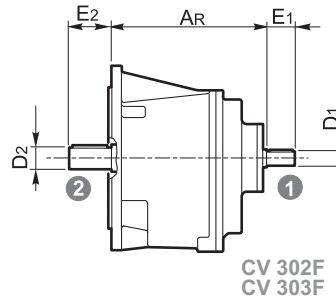

CV 302F
CV 303F

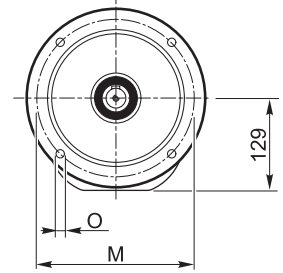

N.B.
F = Flangia integrale
F = Flange mount
F = Integriertem Flansch
F = Bride monobloc
F = Brida integral
F = Brida integral

N

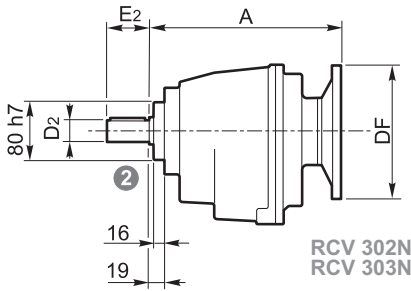

RCV 302N
RCV 303N

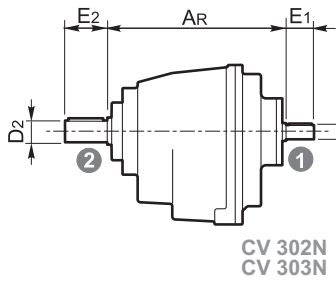

CV 302N
CV 303N

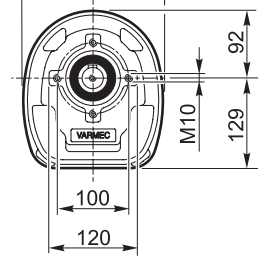

NF

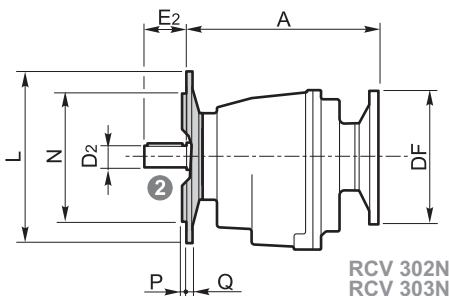

RCV 302NF..
RCV 303NF..

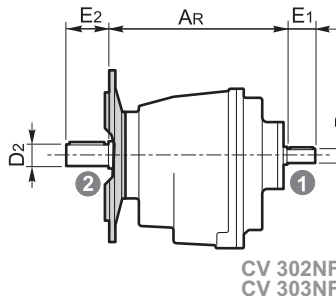

CV 302NF..
CV 303NF..

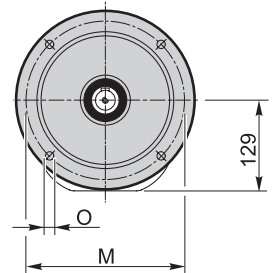

	L	M	N	O	P	Q
NF160	160	130	110	11	3.5	11
NF200	200	165	130	13	3.5	11
NF250	250	215	180	14	4	11
F250	250	215	180	14	4	13

P - F

RCV CV	RCV							CV
	IEC	DF		A	NEMA	DF	A	
		(B5)	(B14)					
302	71	160		249	140	165.1	259	244
	80	200			180	228.6	265	
	90	200						
	100	250	160					
	112	250	160					
	132	300	200		278			
303	63	140		246	56	165.1	254	239
	71	160			140	228.6	254	
	80	200						
	90	200	140					

N - NF

RCV CV	RCV							CV
	IEC	DF		A	NEMA	DF	A	
		(B5)	(B14)					
302	71	160		274	140	165.1	284	269
	80	200			180	228.6	290	
	90	200						
	100	250	160					
	112	250	160					
	132	300	200		303			
303	63	140		271	56	165.1	279	264
	71	160			140	228.6	279	
	80	200						
	90	200	140					