

# Relais Statique Triphasé

## Three Phase Solid State Relays

### Entraxe 47,5mm / 4,75mm mounting

# SVT868394E

24 to 520 VAC - 95ARMS\*  
24A AC-53 50A AC-51

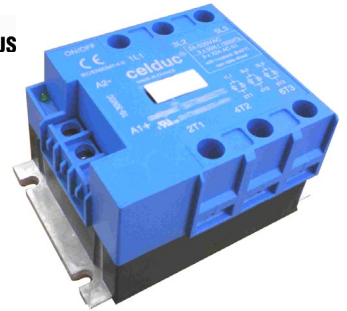

- Sortie AC Synchron. / Pilotage de tout type de charge .
- Commande 8,5-30VDC - LED
- IP20 - protection par réseau RC et VDR -
- Technologie thyristors
- Zero cross AC output . / Designed for all type of load.
- 8,5-30VDC control voltage - LED
- IP20 - RC and VDR protection
- Thyristors technology

#### Dimensions / Dimensions:

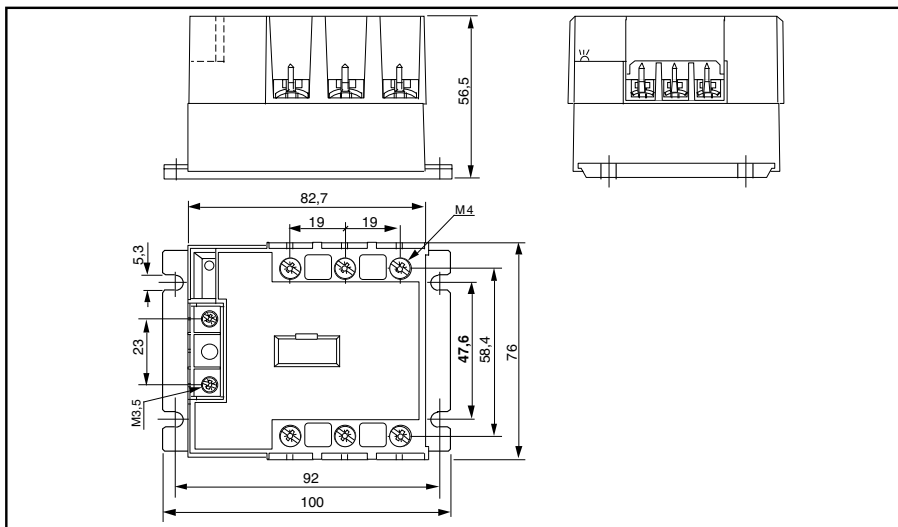

#### Circuit équivalent/Equivalent circuit :

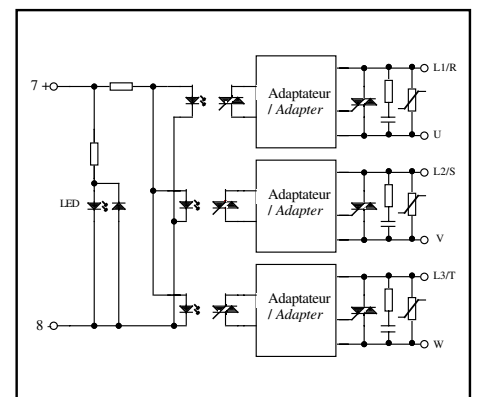

#### Caractéristiques de commande (à 20°C) / Control characteristics (at 20°C)

Paramètre / Parameter	Symbol	DC			Unit
		Min	Nom	Max	
Tension de commande / Control voltage	Uc	8,5	24	30	V
Courant de commande / Control current (@ Uc )	Ic	10	35	45	mA
Tension de relachement/Release voltage	Uc off	4			V
Résistance interne / Input internal resistor fig.1	Rc		620		Ω
Tension inverse / Reverse voltage	Urv		30		V

#### Caractéristiques d'entrée-sortie (à 20°C) / Input-output characteristics (at 20°C)

Isolement entrée-sortie/Input-output isolation @500m	Ui		4000		VRMS
Isolement sortie-semelle/Output-case isolation @500m	Ui		3300		VRMS
Tension assignée isolement/ Rated impulse voltage	Uimp		4000		V

fig. 1 :Caractéristique d'entrée / Control characteristic

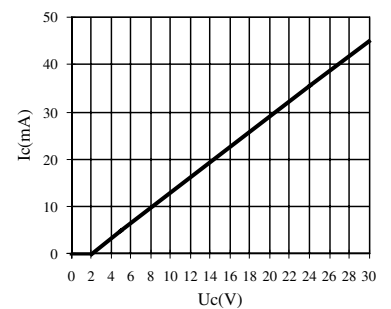

#### Caractéristiques générales / General characteristics

Paramètre / Parameter	Conditions	Symbol	Typ.	Unit
Poids/Weight			410	g
Plage de température de stockage / Storage temperature range			-40 / +100	°C
Plage de température de fonctionnement/Operating temperature range			-40 / +100	°C

Proud to serve you

**celduc**<sup>®</sup>  
r e l a i s

**Caractéristiques de sortie (à 20°C) / Output characteristics (at 20°C)**

Paramètre / Parameter	Conditions	Symbol	Typ.	Unit
Tension de charge / Load voltage		Ue	400	V rms
Plage tension de fonctionnement / Operating range	( 480Vrms + 10% )	Uemax	530	V rms
Tension crête / Peak voltage		Up	1200	V
Niveau de synchronisation / Synchronizing level		Usync	12	V
Tension d'amorçage / Latching voltage	Ie nom	Ua	10	V
Courant nominal AC-51/ AC-51 nominal current	( see Fig. 2 )	Ie AC-51	95*	A rms
Courant nominal AC-53/ AC-53 nominal current	( see Fig. 2 )	Ie AC-53	24	A rms
Courant de surcharge non répétitif / Non repetitive overload current	tp=10ms (Fig. 3)	I <sub>tsm</sub>	1500	A
Chute tension directe crête/ On state voltage drop	@ Ie nom	Vd	1,4	V
Courant de fuite état bloqué/ Off state leakage current	@Ue, 50Hz	I <sub>lk</sub>	5	mA
Courant de charge minimum / Minimum load current		Ie min	5	mA
Temps de fermeture/ Turn on time	Uc nom DC ,f=50Hz	ton max	10	ms
Temps d'ouverture/ Turn off time	Uc nom DC ,f=50Hz	toff max	10	ms
Plage de fréquence / Operating frequency range		f	10-440	Hz
dv/dt état bloqué / Off state dv/dt		dv/dt	500	V/μs
dI/dt maximum non répétitif/ Maximum di/dt non repetitive		di/dt	50	A/μs
I <sup>2</sup> t (<10ms)		I <sup>2</sup> t	11000	A <sup>2</sup> s
EMC Test d'immunité conduite / Conducted immunity level	IEC 1000-4-4 (burst)		2kV criterion A	
EMC Test d'immunité conduite / Conducted immunity level	IEC 1000-4-5(schocks)		2kV criterion A	
Conformité / Conformity	EN60947-4-x			

**Caractéristiques thermiques / thermal curves :**

\* Limited @ 50A  
by the connections

Limité à 50A  
par les connexions

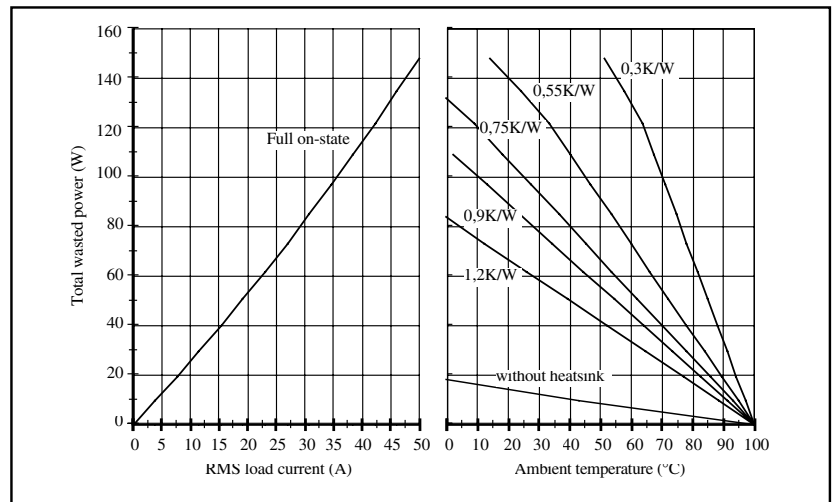
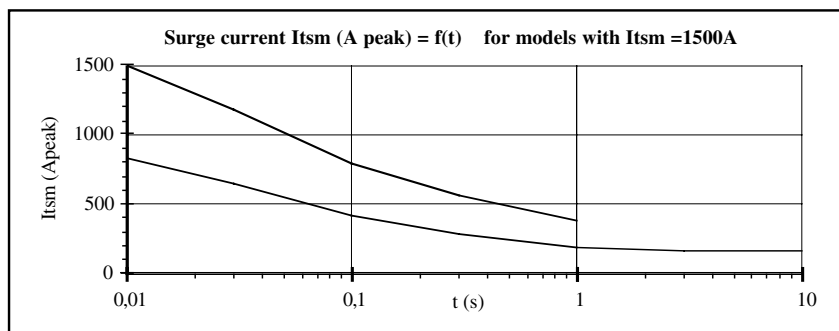

Fig.3 Courbes de surcharge de courant /  
Overload current curves



1 - I<sub>tsm</sub> non répétitif sans tension réappliquée est donné pour la détermination des protections.  
*No repetitive I<sub>tsm</sub> is given without voltage reapplied for the determination of the protection.*

2 - I<sub>tsm</sub> répétitif est donné pour des surcharges de courant (T<sub>j</sub> initiale=70°C). La répétition de ces surcharges de courant diminue la durée de vie du Relais.

*Repetitive I<sub>tsm</sub> is given for inrush current with initial T<sub>j</sub> = 70°C. The repetition of the surge current decrease the lifetime SSR's .*

**Précautions :**

\* Les relais à semiconducteurs ne procurent pas d'isolation galvanique entre le réseau et la charge.



**Cautions :**



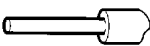
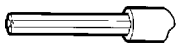
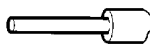
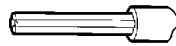

\* Semiconductor relays don't provide any galvanic insulation between the load and the mains.

Proud to serve you

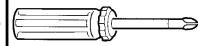
All technical characteristics are subject to change without previous notice.  
Caractéristiques sujettes à modifications sans préavis.

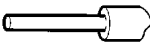
**celduc**<sup>®</sup>  
r e l a i s

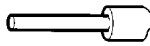
SVT <b>Cablage commande / Wiring of the control circuit:</b>						
nombre de fils/ NUMBER OF WIRES				SCREWDRIVER TYPE		MINIMUM TORQUE couple serrage
1		2		tournevis	tournevis	
SOLID (No ferrule) rigide sans embout	FINE STRANDED (With ferrule) multibrins avec embouts	SOLID (No ferrule) rigide sans embout	FINE STRANDED (With ferrule) multibrins avec embouts			
						N.m
0,75 ... 2,5 mm <sup>2</sup>	0,75 ... 2,5 mm <sup>2</sup>	0,75 ... 2,5 mm <sup>2</sup>	0,75 ... 2,5 mm <sup>2</sup>	0,8 x 5,5 mm	POZIDRIV 2	1,2

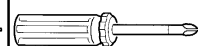
SVT <b>Cablage puissance / Wiring of the power circuit:</b>						
NUMBER OF WIRES				SCREWDRIVER TYPE		MINIMUM TORQUE couple serrage
1		2		tournevis	tournevis	
SOLID (No ferrule) rigide sans embout	FINE STRANDED (With ferrule) multibrins avec embouts	SOLID (No ferrule) rigide sans embout	FINE STRANDED (With ferrule) multibrins avec embouts			
						N.m
1,5 ... 10 mm <sup>2</sup>	1,5 ... 6 mm <sup>2</sup>	1,5 ... 10 mm <sup>2</sup>	1,5 ... 6 mm <sup>2</sup>	0,8 x 5,5 mm	POZIDRIV 2	1,8

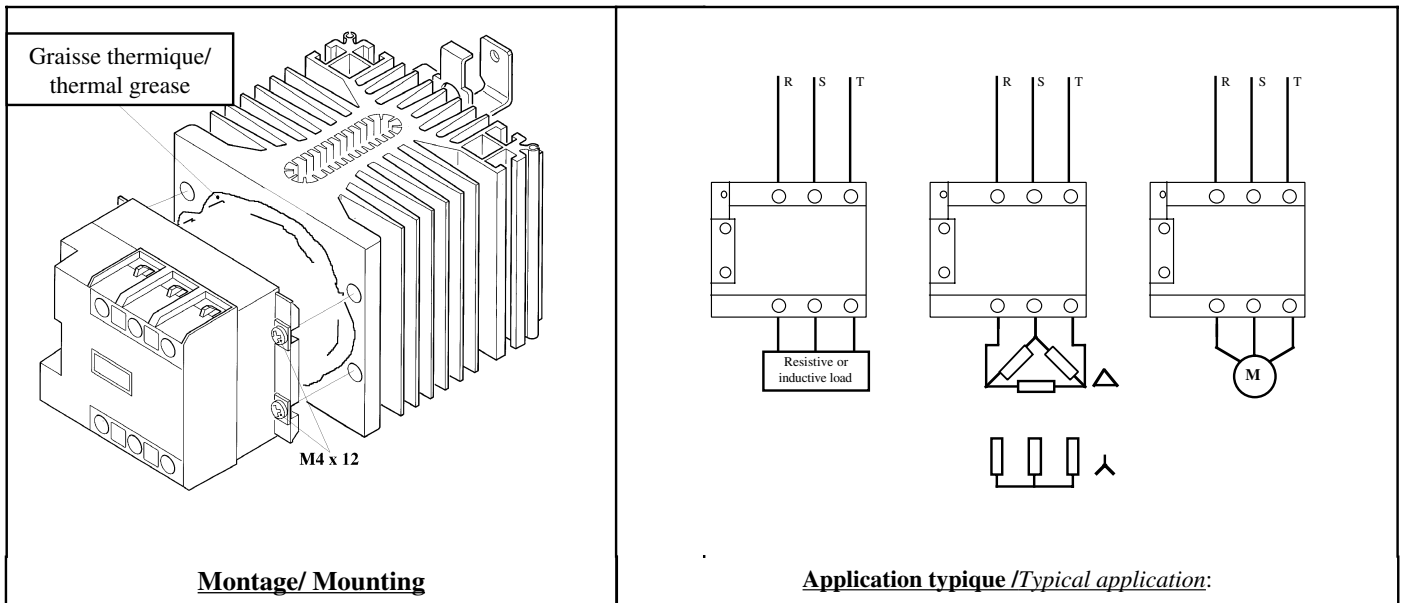

ISO 9001  
N° 1993/1106a

**celduc**<sup>®</sup>  
r e l a i s

[www.celduc.com](http://www.celduc.com)

Rue Ampère B.P. 4 42290 SORBIERS - FRANCE E-Mail : [celduc-relais@celduc.com](mailto:celduc-relais@celduc.com)  
 Fax +33 (0) 4 77 53 85 51 Service Commercial France Tél. : +33 (0) 4 77 53 90 20  
 Sales Dept.For Europe Tel. : +33 (0) 4 77 53 90 21 Sales Dept. Asia : Tél. +33 (0) 4 77 53 90 19