



High Precision Regulators

R210 / R220 / R230 Series

R210 / 220 High Precision Regulator

Features

- Accurate Pressure Regulation. Controls Output Pressure to within 0.1% Accuracy.
- Multi-Stage Regulation for Maximum Control and Stability.
- Two Full Flow Gauge Ports.
- Super Sensitive Relief. Downstream Pressure Buildup, Down to 0.3m bar Above the Set Pressure, is Automatically Vented through Internal Relief Valve.
- R220 has High Exhaust Relief Capacity.



Applications

The R210 and R220 regulators are well suited for any process that requires very precise regulation of air pressure in pipes and vessels. These regulators are often used, but not limited to the following applications:

- Air Gauging
- Gas Mixing
- Calibration Standards
- Air Hoists
- Web Tensioning
- Gate Actuators
- Roll Loading
- Valve Operators
- Cylinder Loading

R210 / R220 Regulator Dimensions		
A 52mm	B 110mm	C 97mm
D 13.5mm		

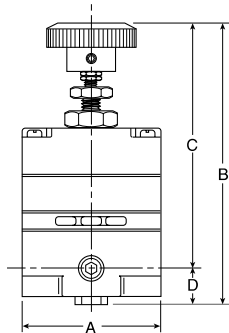

⚠ WARNING

Do not connect regulator to bottled gas.

Do not exceed maximum primary pressure rating.

Product rupture can cause serious injury.

The R210 / R220 are high precision, multi-stage pressure regulators. This pressure controller provides the highest level of regulation accuracy and repeatability available and is ideal for applications that call for the utmost in control and maximum stability under variable operating conditions. A stainless steel measuring capsule is used as a sensing element to activate the high gain servo balanced control mechanism in which the main valve is controlled by a pilot valve. This allows for greater accuracy and eliminates many of the problems associated with conventional regulators using range springs and diaphragms.

Ordering Information

		Reduced Pressure Range (Bar)		
Relieving		0.13 to 2.7	0.13 to 8.2	0.13 to 8.2 High Relief
In / Out Ports	1/4"	R210G02A	R210G02C	R220G02C

Technical Information

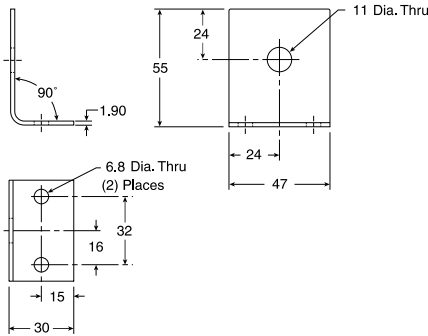
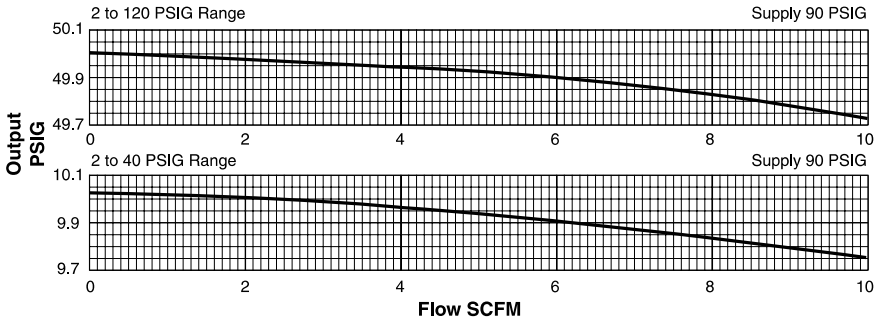

Mounting Bracket: 446-707-045

R210 / R220 Regulator Kits & Accessories

Mounting Bracket Kits

- Pipe Mounting **SA200YW57**
- Right Angle Mounting..... **446-707-045**

Service Kits

- 0.13 to 2.7 bar **RKR210A**
- 0.13 to 8.2 bar **RKR210C**
- 0.13 to 8.2 bar (High Relieving) **RKR220C**

Materials of Construction

- Adjusting Stem & Capsule Stainless Steel
- Body Zinc
- Control Knob Plastic
- Diaphragm(s) Buna-N
- Seals Buna-N
- Springs Stainless Steel
- Valve Poppet Stainless Steel

Specifications

Constant Bleed Rate	Less than 0.15m ³ /hr (Equals Bleed Rate plus other consumption)
Total Air Consumption	0.21m ³ /hr.
Effect of Supply Pressure Variation of 1.7 bar on outlet:	Less than 0.3m bar
Exhaust (Relief) Capacity At 0.34 bar above 1.38 bar Setpoint	
Standard Model	3.4m ³ /hr
High-Relief Model	17m ³ /hr
Flow Capacity	
At 9 bar Supply,	
1.38 bar Outlet	25m ³ /hr
Gauge Ports	1/4"
(Can be used as additional full flow 1/4" outlet ports)	
Operating Pressure Range:	bar
PRIMARY – Maximum	10
SECONDARY – Spring Pressure	
2.7 bar Minimum	0.14
Maximum	2.70
8.2 bar Minimum	0.14
Maximum	8.2
Operating Temperature Range	-18°C * to 65°C
* Temperatures below 0°C require moisture free air.	
Repeatability / Sensitivity	0.3m bar Inches of Water Column = 1/8"
Weight640g

R230 High Flow Precision Regulator

Features

- Adjusting Knob.
- Diaphragm Design for Good Repeatability, Response and Sensitivity.
- Balanced Poppet.
- Two Full Flow Gauge Ports.
- Precise Regulation. Will Sense a Decrease in Downstream Pressure as Small as 1/4" of Water.
- High Flow Capacity. Flows of 37.8dm³/s Attainable with Minimal Drop.
- Stable Output. Dampening Action of Aspiration Tube makes Regulator Insensitive to Changes in Flow.
- On-line Maintenance. Can be Serviced Without Removal of Air Line.

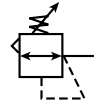

R230 Regulator Dimensions		
A 76mm	B 10mm	C 86mm
D 154mm	E 57mm	

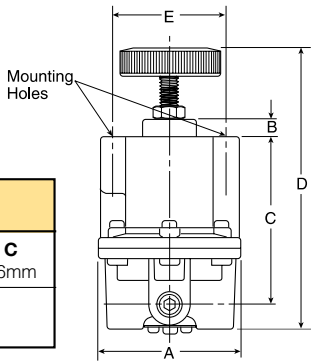

Applications

The R230 regulators are an ideal choice for any application that calls for accurately maintained output pressure under high flow conditions. This includes, but is not limited to such applications as:

- Test Equipment
- Gas Mixing
 - Valve Operators
 - Positioning Cylinders
 - Laboratory Equipment
 - Web Tensioning
 - Clutch & Brake Controls
 - Roll Loading
 - Test Panels
 - Actuators

⚠ WARNING

Do not connect regulator to bottled gas.

Do not exceed maximum primary pressure rating.

Product rupture can cause serious injury.

The R230 is designed for applications that require high flow capacity and accurate process control. A poppet valve which is balanced by utilizing a rolling diaphragm, insures a constant output pressure even during wide supply pressure variations. Stability of regulated pressure is maintained under varying flow conditions through the use of an aspirator tube which adjusts the air supply in accordance with the flow velocity.

Ordering Information

		Reduced Pressure Range (Bar)			
Relieving		0 to 0.13	0 to 2	0 to 4	0 to 10
In / Out Ports	1/4"	R230G02E	R230G02B	R230G02C	R230G02D

Technical Information

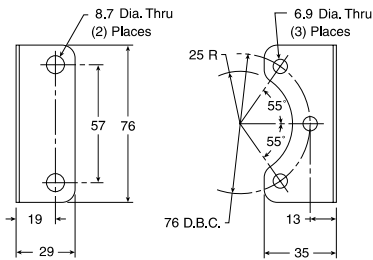
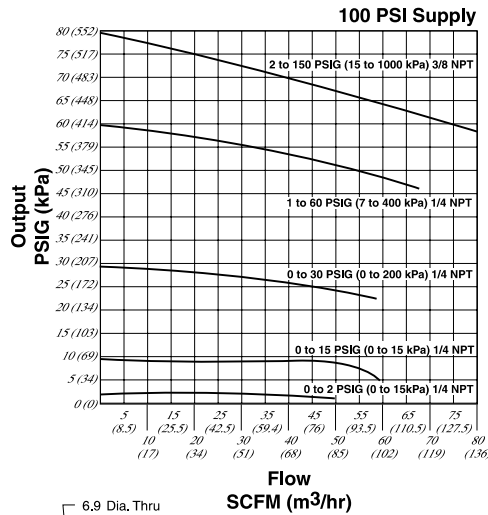

Mounting Bracket: 446-707-025

R230 Regulator Kits & Accessories

Mounting Bracket Kit 446-707-025

Service Kits – Relieving

- 0 to 0.13 bar RKR230E
- 0 to 2 bar RKR230B
- 0 to 4 bar RKR230C
- 0 to 10 bar RKR230D

Materials of Construction

- Adjusting Stem & Spring Steel
- Biased Spring Stainless Steel
- Body, Bonnet Aluminum
- Control Knob Plastic
- Diaphragm Buna-N Elastomer and Polyester Fabric
- Seals Buna-N
- Valve Poppet Brass
- Valve Poppet Seat Buna-N

Specifications

- Constant Bleed Rate upto 0.35m³/h
(Depending upon output pressure)
- Gauge Ports Two Ports 1/4"
(Can be used as additional Full Flow 1/4 Inch Outlet Ports)
- Effect of Supply Pressure Variation –
Less than 6mbar for 6.89 bar change
- Exhaust (Relief) Capacity –
1.88 dm³/s with downstream pressure 0.3 bar above set pressure.
Exhaust commences at 0.7m bar above set pressure.
- Flow Capacity –
At 6.89 bar Supply,
5.5 bar Outlet..... 37.8 dm³/s
- Operating Temperature Range – -40°C to 71°C
- Operating Pressure Range – bar
PRIMARY – Maximum 17
- Port Threads 1/4"
- Exhaust (Relief) Capacity 1.88 dm³/s
(Downstream pressure 0,3 bar above set pressure)
- Repeatability / Sensitivity 6m bar
Inches of Water Column = 1/4"
- Response 250 ms
The valve will open to full flow and fill a volume of 1250 cm³
- Weight 740g

